

FM 3-57

CIVIL AFFAIRS OPERATIONS



JULY 2021

DISTRIBUTION RESTRICTION:

Approved for public release; distribution is unlimited.

This publication supersedes FM 3-57, dated 17 April 2019.

HEADQUARTERS, DEPARTMENT OF THE ARMY

This publication is available at the Army Publishing Directorate (APD) site (<https://armypubs.army.mil>) and the Central Army Registry site (<https://atiam.train.army.mil/catalog/dashboard>).

Foreword

In virtually every conflict since the founding of our nation, the military either supported civil administration in partner nations or provided transitional governance in occupied territories. If history is any indication of the future, the requirement for the Army to conduct governance operations is as valid and relevant as ever. As an Army, we must not only capture and learn from our past successes, but also from our mistakes and failures.

Historical vignettes are powerful tools to understand and describe Civil Affairs Operations. Following the Spanish-American War, U.S. Army Military Government entities transferred authority to the Cuban people. The "Hunt Report," which detailed American Military Government's occupation of the Rhineland after the end of World War I, became the Army's military government textbook. World War II provides foundational examples where the Army performed governance operations simultaneously with large-scale combat operations. The Army rapidly consolidated gains, reestablished political order, and provided services to liberated populations to secure the victory. For this mission, the U.S. War Department created the Civil Affairs Division to provide the expertise in planning and execution of Military Government. U.S. Army Officers were required to be military governors of Germany and Japan, responsible for a historic reconstruction effort.

More recently in Syria, as the Special Operations Joint Task Force-Operation Inherent Resolve Commander, we employed Special Operations Civil Affairs Soldiers to identify and characterize political dynamics throughout Syria. They synchronized humanitarian efforts, fostered indigenous cooperation, and advised budding Civil Councils in Syria following the physical defeat of Islamic State.

Trends in the future operational environment point to operations among populations in a complex multi-domain extended battlefield, including dense urban areas. Currently, Civil Affairs Soldiers deploy worldwide to Counter Violent Extremism and enable Great Power Competition against our near-peer adversaries. Through their activities, Civil Affairs Soldiers advance strategic partnerships, enhance situational understanding for Commanders, and shape the operational environment.

The modernization of Civil Affairs doctrine is a crucial step to generate, train, and equip a ready-to-deploy force. This revision of FM 3-57 clarifies the role, tactics, and taxonomy for Civil Affairs Operations. My intent is to arm military leaders with common understanding for integration of the Civil Affairs capability.



PATRICK B. ROBERSON
Major General, USA
Commandant
Special Operations Center of Excellence

This page intentionally left blank.

Civil Affairs Operations

Contents

	Page
	PREFACE.....iv
	INTRODUCTIONv
Chapter 1	CIVIL AFFAIRS BRANCH OVERVIEW..... 1-1
	Role 1-1
	Authorities..... 1-2
	Core Competencies 1-4
	Civil Affairs Missions..... 1-6
	Branch Characteristics 1-9
	Branch Principles..... 1-9
Chapter 2	CIVIL AFFAIRS OPERATIONS 2-1
	Overview..... 2-1
	The Civil Component..... 2-1
	Core Competencies..... 2-3
	Transitional Governance 2-3
	Civil Network Development and Engagement..... 2-10
	Civil Knowledge Integration 2-16
	Civil-Military Integration 2-20
Chapter 3	UNIFIED LAND OPERATIONS 3-1
	Civil Affairs Contribution to Operations 3-1
	Army Strategic Roles..... 3-2
	Transition Operations 3-4
	Decisive Action 3-5
	Populace and Resources Control..... 3-12
	Homeland Defense 3-17
	The Extended Battlefield 3-17
	Competition Continuum..... 3-19
Chapter 4	OPERATIONS STRUCTURE..... 4-1
	Overview..... 4-1
	Civil Affairs Role in the Operations Process..... 4-1
	Staff Integration 4-6

Distribution Restriction: Approved for public release; distribution is unlimited.

Contents

	Mission Variables	4-12
	Operational Variables	4-12
	Synthesizing Operational and Mission Variables.....	4-12
	Civil Information Collection Plan	4-13
	Area Studies.....	4-13
	Civil Affairs Assessments.....	4-13
	Running Estimate.....	4-14
	Annexes	4-16
	Civil Affairs Role in Mission Command.....	4-17
	Civil Affairs Role in the Warfighting Functions.....	4-17
	Civil Affairs Capability by Echelon	4-24
Chapter 5	UNIFIED ACTION	5-1
	Overview	5-1
	Interorganizational Cooperation.....	5-1
	Joint Operations	5-3
	Civil-Military Operations Directorate of a Joint Staff	5-4
	Theater Civil Affairs Planning Team	5-5
	Joint Task Force.....	5-6
	Civil-Military Operations Planning Considerations.....	5-6
	Civil-Military Operations Working Group.....	5-7
	Joint Interagency Coordination Group.....	5-8
	Civil-Military Engagement	5-9
	Interagency Coordination.....	5-10
	The Role of United States Embassies	5-13
	Defense Support to Stabilization.....	5-14
Appendix A	HISTORY OF CIVIL AFFAIRS	A-1
Appendix B	CIVIL AFFAIRS GOVERNMENT FUNCTION EXPERTISE	B-1
Appendix C	CIVIL AFFAIRS IN SPECIAL OPERATIONS	C-1
Appendix D	CIVIL AFFAIRS GRAPHIC CONTROL MEASURES	D-1
	GLOSSARY	Glossary-1
	REFERENCES.....	References-1
	INDEX	Index-1

Figures

Introductory figure. Civil Affairs logic chart.....	vi
Figure 1-1. Civil Affairs core competencies and missions	1-5
Figure 2-1. Government function specialty areas and focus areas	2-5
Figure 2-2. Transitional governance across the competition continuum	2-6
Figure 2-3. Civil network development and engagement process.....	2-11
Figure 2-4. Achieving understanding	2-17
Figure 2-5. Civil knowledge integration process	2-18
Figure 2-6. Notional Civil Affairs civil-military operations center configuration.....	2-22

Figure 3-1. Decisive action 3-6

Figure 3-2. Civil Affairs support to a corps offensive 3-11

Figure 4-1. Civil Affairs inputs and outputs in the military decision-making process 4-2

Figure 4-2. Military decision-making process–running estimate sync chart..... 4-15

Figure 4-3. Civil Affairs in the warfighting functions 4-18

Figure 4-4. Civil Affairs allocations and support functions 4-25

Figure 4-5. Civil Affairs workload rule of allocation 4-27

Figure 5-1. International agreements according to
Department of Defense Issuance 5530.3 5-12

Figure 5-2. Components of foreign assistance..... 5-15

Figure 5-3. Security assistance and foreign internal defense 5-19

Figure C-1. Civil Affairs operations in unconventional warfare C-2

Figure D-1. Main and modifier icon and amplifier placement locations D-1

Figure D-2. Standard template point D-17

Figure D-3. Standard area template D-17

Tables

Introductory table. New and revised terms viii

Table 4-1. Example of political, military, economic, social, information,
and infrastructure/areas, structures, capabilities, organizations,
people, and events analysis..... 4-11

Table D-1. Description of main icon and amplifier fields for unit frames D-2

Table D-2. Civil Affairs command framed symbols D-4

Table D-3. Civil Affairs brigade framed symbols D-5

Table D-4. Civil Affairs battalion framed symbols..... D-6

Table D-5. Civil Affairs company framed symbols..... D-7

Table D-6. Civil Affairs headquarters elements framed symbols D-7

Table D-7. Civil Affairs team framed symbols D-8

Table D-8. Civil Affairs elements D-9

Table D-9. Organizations and individuals..... D-12

Table D-10. Modifiers for individuals and organizations D-13

Table D-11. Civilian installations D-14

Table D-12. Civilian activities D-15

Table D-13. Amplifier descriptions for control measure symbols D-18

Table D-14. Civil network development symbols D-19

Table D-15. Civil reconnaissance symbols D-20

Table D-16. Civil engagement symbols..... D-21

Preface

FM 3-57 provides Army commanders with the information necessary for the integration of Civil Affairs forces and capabilities, by echelon, in support of unified land operations. It also provides the doctrinal basis for the conduct of Civil Affairs operations in support of unified action.

FM 3-57 clarifies the role of Civil Affairs forces in the execution of Civil Affairs operations with regard to the missions, employment, support requirements, capabilities, and limitations of these forces. Civil Affairs forces execute Civil Affairs operations in support of unified land operations in all theaters, at all echelons, across the competition continuum to achieve unity of effort. A force multiplier for every commander, Civil Affairs forces are one of the primary resources a commander has to assist in understanding and managing the complex and ever-changing civil component of the operational environment. Civil Affairs forces are trained, organized, and equipped to plan, execute, and assess Civil Affairs operations in support of Army and joint operations. Cultural orientation, regional expertise, linguistic capabilities, advisory skills, civil network development expertise, and civilian-acquired professional experience in common government functions distinguish Civil Affairs forces from other enablers. This makes Civil Affairs forces essential to the success of all missions that occur near, among, or with civilian populations, governments, or interorganizational partners.

The principal audience for FM 3-57 is the leadership of the Army, officers, and senior noncommissioned officers who command Army forces or serve on the staffs that support those commanders of operations across the conflict continuum. It is also an applicable reference for the civilian leadership of partner United States departments and agencies.

This manual is written primarily to assist the Army component commands, Army corps, Army divisions, brigade combat teams, maneuver enhancement brigades, theater special operations commands, and special operations task forces with the integration of Civil Affairs operations in planning, preparing for, executing, and assessing unified land operations.

Commanders, staffs, and subordinates ensure their decisions and actions comply with applicable United States, international, and, in some cases, host-nation laws and regulations. Commanders at all levels ensure their Soldiers operate in accordance with the law of war and the rules of engagement. (See FM 6-27.)

FM 3-57 uses joint terms, where applicable. Selected joint and Army terms and definitions appear in both the glossary and the text. Terms for which FM 3-57 is the proponent publication (the authority) are marked with an asterisk (*) in the glossary. Definitions for which FM 3-57 is the proponent publication are **boldfaced** in the text. For other definitions shown in the text, the term is *italicized* and the number of the proponent publication follows the definition.

FM 3-57 applies to the Active Army, the Army National Guard (or Army National Guard of the United States), and the United States Army Reserve unless otherwise stated.

The proponent of FM 3-57 is the U.S. Army Special Operations Center of Excellence, U.S. Army John F. Kennedy Special Warfare Center and School. Send comments and recommendations on a DA Form 2028 (*Recommended Changes to Publications and Blank Forms*) to Commander, U.S. Army Special Operations Center of Excellence, USAJFKSWCS, ATTN: AOJK-CAD, 3004 Ardennes Street, Stop A, Fort Bragg, NC 28310-9610; by email to cadoctrine@socom.mil; or by submitting an electronic DA Form 2028.

Introduction

The Army executes operations across multiple domains and in complex environments. One of the most complex environments is the land domain—partially due to the societal systems (detailed in JP 3-57) woven into the operational environment. The Army refers to these societal systems as operational variables. These operational variables are political, military, economic, social, information, infrastructure, physical environment, and time. Disagreements, perceived grievances, and divergent cultural and political views within these systems may contribute to instability and conflict among the indigenous populations and institutions that can be exploited by our adversaries, or otherwise interfere with military operations.

Commanders require situational understanding that is as complete as possible to achieve their desired end states. Propaganda, deception, disinformation, misinformation, and the ability of individuals and groups to influence populations through technologies reflect the increasing speed of interaction. Leaders must consider all factors that make up their operational environment—such as social factors that initiate and sustain conflict and those existing capabilities within the resident population that can be leveraged or enhanced to create stability and reduce conflict. Failure to consider these factors may lead to misunderstandings, miscalculations, and faulty plans that do not address the desired end state and ultimately lead to strategic failure. FM 3-57 describes the history, authorities, role, core competencies, missions, characteristics, principles, and limitations of Army Civil Affairs forces in support of unified land operations.

Understanding the operational variables of the operational environment provides the basis for Civil Affairs operations. The operational variables provide a means to develop a comprehensive understanding of an operational environment, independent of threat or enemy activity. Information collection against each of the operational variables (political, military, economic, social, information, infrastructure, physical environment, and time) inherently calls for collectors grounded in understanding the dynamics of civilian populations, government institutions, and civil society organizations in the context of history, geography, and available resources. Military operations require formations that—

- Understand baseline conditions in each of the operational variables.
- Engage the right sources of leadership and influence.
- Take actions to counter or change human perceptions and activities that do not align with mission objectives.
- Influence and create changes in the operational variables that support operational end states and goals.

Commanders engage with key leaders to mobilize populations to regain control of the civil component of the operational environment. This facilitates a return to or achievement of a safe, secure, and stable environment. Civil Affairs forces, under the authority of these commanders, provide a conditions-based capability that focuses on the civil component to enhance situational understanding, address civil factors that empower achievement of the military objective, and support unified action.

The Civil Affairs logic chart (introductory figure) depicts how Civil Affairs forces support the Army strategic goals through the conduct of Civil Affairs operations. Through the engagement and development of civil networks, Civil Affairs forces enable the operational goals of shape, prevent conflict, prevail in large-scale combat operations, and consolidate gains.

Civil Affairs operations are nested in unified land operations and executed through decisive action. The logic chart shows how the developed civil knowledge is integrated into the operations processes to—

- Enable mission command.
- Increase situational understanding.
- Refine targeting and effects.
- Enable effective information operations.
- Enhance freedom of maneuver and preserve combat power.
- Achieve increased stability through consolidation of gains.

This enhances Army commanders' abilities to reach the ultimate goals of—

- Enabling mission command.
- Shaping the operational environment.
- Maintaining operating tempo.
- Preserving combat power.
- Consolidating gains.
- Creating effects in the civil component to support the four strategic roles of the Army, which are—
 - Shape operational environments.
 - Prevent conflict.
 - Prevail in large-scale combat operations.
 - Consolidate gains.

FM 3-57 provides Army Civil Affairs capstone doctrine as a foundation for employment of the force during all phases of operations. FM 3-57 contains five chapters and four appendixes.

Chapter 1 highlights the roles, authorities core competencies, missions, characteristics, and principles of the Civil Affairs branch.

Chapter 2 describes Civil Affairs operations, which establish and enhance shared understanding of the civil component of the operational environment and create effects in military operations. The discussion details the core competencies and missions executed within Civil Affairs operations that enable success across the competition continuum.

Chapter 3 focuses on the four Army strategic roles and describes the contribution of Civil Affairs operations to unified land operations within the framework of the four tasks of decisive action. This chapter also describes the interactions between Civil Affairs forces and other organizations and operations in the multi-domain extended battlefield. Finally, this chapter describes the Civil Affairs contribution to achieving enduring objectives during competition through civil network development and enhanced governance.

Chapter 4 details the integration of Civil Affairs forces into the Army operations structure, the capabilities of Civil Affairs forces by echelon, and the role of Civil Affairs task forces.

Chapter 5 outlines the role of Civil Affairs forces in integrating, coordinating, and synchronizing partners and interorganizational elements to ensure unity of effort in support of joint forces in unified action.

Appendix A is a brief history of United States Army Civil Affairs forces, highlighting some critical events during its continuous evolution.

Appendix B provides a description of the role Civil Affairs government function specialists and the capabilities they provide in the provision of governmental sector expertise.

Appendix C describes the role of Civil Affairs forces in special operations and highlights the role of Civil Affairs forces in unconventional warfare, direct action, counterterrorism, and countering weapons of mass destruction.

Appendix D focuses on a variety of symbols and graphic control measures related to Civil Affairs and Civil Affairs missions.

FM 3-57 adds or revises the terms listed in the introductory table.

Introductory table. New and revised terms

Term	Acronym	Remarks
civil engagement	CE	Revised Army definition
civil knowledge integration	CKI	New Army term, definition, and acronym
civil-military integration	CMI	New Army term, definition, and acronym
civil network	--	New Army term and definition
civil network analysis	CNA	New Army term, definition, and acronym
civil network development	CND	New Army term, definition, and acronym
civil network development and engagement	CNDE	New Army term, definition, and acronym
civil preparation of the battlefield	CPB	New Army term, definition, and acronym
support to civil administration	SCA	Revised Army definition
transitional governance	TG	New Army term, definition, and acronym

Chapter 1

Civil Affairs Branch Overview

...you will take every step in your power to preserve tranquility and order in the city and give security to individuals of every class and description—restraining as far as possible, till the restoration of civil government, every species of persecution, insult, or abuse, either from the soldiery to the inhabitants or among each other.

General George Washington
19 June 1778

United States (U.S.) forces operate in all domains. The diversity of populations makes the land domain most complex because of its intricate design, which includes cultures, ethnicities, religion, and varied political settings. This complex design is described as the civil component of the operational environment (OE). Civil Affairs (CA) forces are the Army capability responsible for the analysis and evaluation and integration of all civil considerations.

War is, and has always been, fought among populations. As such, no military efforts can be divorced from those populations and the effects on those populations. From the early days of U.S. military operations—beginning with the American Revolution and continuing to present day—U.S. Soldiers have been charged with understanding, assisting, or providing governance over indigenous populations and institutions (IPI) in peacetime, war, and post-conflict environments. Following World War II, the U.S. military established military governments in Korea, Japan, and Germany. More recently, CA forces supported civil administrations in Kuwait, Iraq, Afghanistan, and Syria by conducting a broad range of Civil Affairs operations (CAO), supporting the Department of Defense (DOD) mission, and meeting DOD component responsibilities to the civilian sector.

This chapter highlights the policy and directive authorities for CA. This chapter also introduces new taxonomy to describe the role, core competencies, missions, characteristics, and principles of the CA branch.

ROLE

1-1. The role of CA is to engage and leverage the civil component of the OE while enhancing, enabling, or providing governance. CA forces accomplish this through the execution of the CA core competencies throughout the range of military operations and across the competition continuum. These CA missions are designed to provide and enable commanders with the capabilities to find, disrupt, and defeat threats within the civil component. Threats in the civil component could be ineffective government, infrastructure degradation, criminal threats, asymmetric threats, and other factors that lead to unstable environments. Through CAO, CA forces enable mission command, increase situational understanding, preserve combat power, and consolidate gains in support of the strategic objective of establishing a secure and stable OE that is consistent with U.S. interests. CA forces are specifically organized, trained, and resourced to address the civil environment and to integrate civil knowledge, resources, and considerations into decision making during activities that span the competition continuum.

AUTHORITIES

1-2. U.S. Army CA forces provide the only CAO capability to the Army and joint force. The following policy directives establish the basis for the capabilities required of CA forces.

DEPARTMENT OF DEFENSE DIRECTIVE 5100.01

1-3. DODD 5100.01 provides authority and guidance to the U.S. Army to “develop concepts, doctrine, tactics, techniques, and procedures, and organize, train, equip, and provide forces with expeditionary and campaign qualities.” DODD 5100.01 also specifically states the following requirements for the Army:

- Organize, train, and equip forces to conduct support to civil authorities in the U.S. and abroad, to include support for disaster relief, consequence management, mass migration, disease eradication, law enforcement, counter-narcotics, critical infrastructure protection, and response to terrorist attacks. The Army does this in coordination with the other military Services, combatant commands, the National Guard, and United States government (USG) departments and agencies.
- Conduct CAO.
- Occupy territories abroad and provide for the initial establishment of a military government pending transfer of this responsibility to other authority.

1-4. DODD 5100.01 specifies that the United States Special Operations Command (USSOCOM)—in coordination with the military Service chiefs—organize, train, equip, and provide special operations forces (SOF), doctrine, procedures, and equipment for CAO.

DEPARTMENT OF DEFENSE DIRECTIVE 2000.13

1-5. DODD 2000.13 states that CAO includes DOD actions that—

- Coordinate military activities with other USG departments and agencies, civilian agencies of other governments, host-nation military or paramilitary elements, and nongovernmental organizations (NGOs).
- Support stability operations (including activities that establish civil security), provide support to governance, provide essential services, support economic development and infrastructure, and establish civil control for civilian populations in occupied or liberated areas until such control can be returned to civilian or non-U.S. military authority.
- Provide assistance outside the range of military operations, when directed, to meet the life-sustaining needs of the civilian population.
- Provide expertise in civilian sector functions that normally are the responsibility of civilian authorities. That expertise is applied to implement DOD policies to advise or assist in rehabilitating or restoring civilian sector functions.
- Establish and conduct military government until civilian authority or government can be restored.

Note: DODD 2000.13 provides additional information on the DOD-directed requirements.

TITLE 10, UNITED STATES CODE

1-6. Title 10, United States Code (10 USC) directs Army forces to conduct prompt and sustained land combat, combined with the Army’s operating concept, and unified land operations requirements. Land operations, particularly large-scale combat operations, focus on destroying or dislocating enemy forces or securing key land objectives that reduce the enemy’s ability to conduct operations. Five characteristics distinguish land operations—

- Scope.
- Duration.
- Terrain.
- Permanence.
- Civilian presence.

1-7. Acknowledging civilian presence underscores the criticality of and the dynamic relationship between friendly forces, adversaries, and populations. These relationships affect and are affected by daily changes in the area of operations (AO). Several factors impact each AO, such as competing global and regional influences; urbanization; failed, failing, or recovering governance apparatus; non-state actors; other state actors; degraded economic conditions; pandemics; and other health crises. CA forces enable focused insights and understanding of the complex relationships and influences affecting civil societies, institutions, and populations within the AO. This enables commanders and their forces to have a clear understanding of the common operational picture. CA forces provide unique capabilities to engage the civil component, enabling consolidation activities that are fundamental to the stability of the affected population and civic institutions.

TITLE 22, UNITED STATES CODE

1-8. Most CAO will be conducted under the authority of 10 USC. However, there are some circumstances in which CAO will be conducted under 22 USC. 22 USC 2292 through 2292b address the international disaster assistance funds. The President may direct the DOD through the Secretary of Defense (SecDef) to respond to human-made or natural disasters. The President delegates disaster relief authority to the SecDef with concurrence of the Department of State (DOS) (except in emergencies). The DOD has limited authority to engage in disaster assistance. Through 22 USC 2292, Congress and the President provide the authorization for the U.S. to provide assistance to certain countries. Generally, each section after 2292b indicates particular countries that will be the intended recipient of this aid and additional countries will undoubtedly be added to the list as the magnitude of the disaster is known. In addition to funds mentioned in 10 USC, the bulk of foreign humanitarian assistance (FHA) operations will be funded in accordance with 22 USC 2292.

1-9. 22 USC 2151 is the Foreign Assistance Act. This act is designed to focus on developing countries. It supports military assistance programs, foreign military financing programs, and international military education training programs. The Foreign Assistance Act also supports economic support funds; peacekeeping operations; international narcotics control and law enforcement programs; and nonproliferation, antiterrorism, demining, and related programs. The act contains provisions to assist foreign countries in fighting internal and external aggression by providing various forms of military assistance upon request (contingent upon Congressional approval). Despite a large DOD role in providing defense-related articles and services, the DOS controls the Foreign Assistance Act. This act also mandates close coordination and cooperation between the DOD and U.S. civilian agencies at all levels of the security assistance (SA) process.

1-10. SA is a group of programs implemented by DOD in accordance with policies established by the DOS, through which the U.S. provides defense articles, military training, and other defense-related services to foreign nations by grant, loan, credit, or cash sales in furtherance of national policies and objectives. These programs are governed by 22 USC. CA forces enable, synchronize, coordinate, and integrate civil information and knowledge into the planning and development of the common operational picture for these missions. CA forces can also provide civil measures of performance or measures of effectiveness to determine the impact on the IPI.

1-11. CA forces in support of SA programs are able to—

- Identify host-nation requirements.
- Develop civil networks to enable mission requirements.
- Develop or review the nomination list of programs or projects to support the mission.
- Make a determination of the feasibility of each program.

1-12. The five principal components of SA are—

- Foreign military sales.
- Foreign military financing.
- International military education and training.
- Peace operations.
- Excess defense articles.

CORE COMPETENCIES

1-13. CA forces focus on the interests; functions; capabilities; and vulnerabilities of populations, institutions, government apparatus, and unified action partners that reside or operate in and around an AO. The role and missions of the CA branch form the basis for training, organizing, equipping, and employing CA forces. The CA missions are the execution of capabilities that allow the CA force to accomplish its role.

1-14. Core competencies define the overall capabilities of a branch to the Army. The CA branch has the following core competencies:

- Transitional governance (TG).
- Civil network development and engagement (CNDE).
- Civil knowledge integration (CKI).
- Civil-military integration (CMI).

1-15. CA core competencies are mutually reinforcing, interdependent, and designed to address critical operational gaps with capabilities that are not organic to any other Army branch. At echelon, the ranges of capability and capacity to execute the CA core competencies vary significantly. For example, a CA company or team will have limited capability and capacity to augment the company requirements. On the other hand, a CA battalion will have greater capability and capacity to augment the company requirements. In addition, there are further and more specific capabilities that reside in the higher echelons of the CA force, such as reachback. As a result, understanding the capabilities and limitations of CA organizations is helpful in employing CA forces efficiently and effectively. Ultimately, the goal of the execution of the core competencies is to coordinate, integrate, and synchronize the civil component with Army operations to achieve unified action.

1-16. Figure 1-1 depicts the CA core competencies and functions. The foundation of the structure is CA missions which are found in all the core competencies in some combination. The central pillars of the structure are TG and CNDE, which focus the other core competencies through interactions with the individuals and networks that make up the civil component. Next, the support pillars of CKI and CMI provide structure and guidance to ensure CA forces work in tandem with the overall military campaign while integrating civilian partners to create unity of effort. Finally, CAO is the roof which the competencies support. These core competencies, working in concert, create stability and enable consolidation of gains within the civil component. The CA missions are housed within the framework of the core competencies and provide execution of CA capabilities at the tactical level.

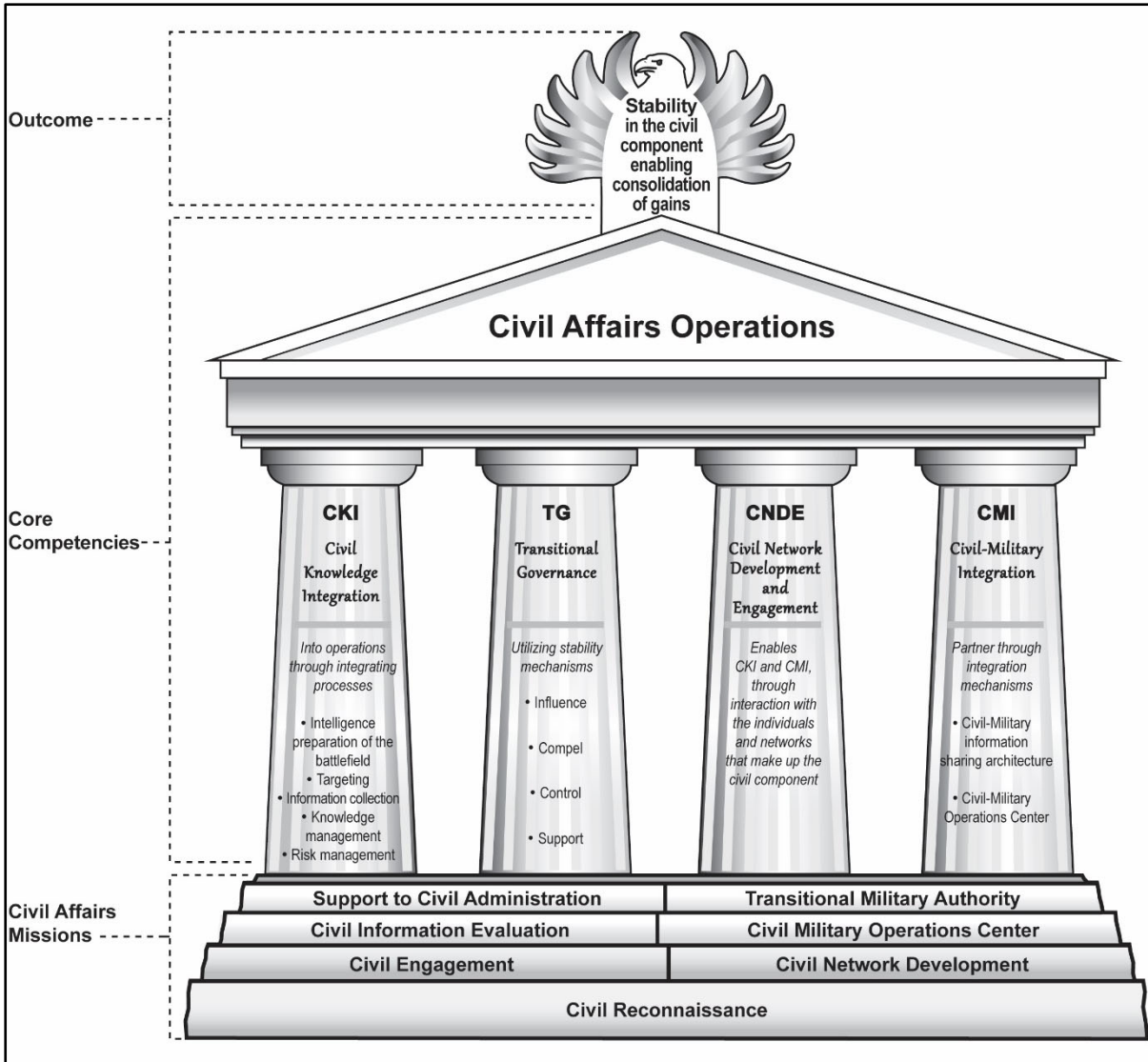


Figure 1-1. Civil Affairs core competencies and missions

TRANSITIONAL GOVERNANCE

1-17. TG is essential for maintaining stability in periods of competition, promoting resilience in periods of crisis, and assuring continuity of governance during armed conflict. **Transitional governance** is the actions taken to assure appropriate control and continuity of government functions throughout the range of military operations. DODD 5100.01 directs the Army to establish a military government when occupying enemy territory, and DODD 2000.13 identifies a military government as a directed requirement under CAO.

CIVIL NETWORK DEVELOPMENT AND ENGAGEMENT

1-18. **Civil network development and engagement** is the activity by which the civil network capabilities and resources are engaged, evaluated, developed, and integrated into operations. Developing and engaging civil networks provides commanders with a more complete understanding of the OE, while providing access to use those networks to shape the operational outcomes. A **civil network** is a collection of formal and informal groups, associations, military engagements, and organizations within an operational environment that interact with each other with varying degrees of frequency, trust, and collaboration. Civil networks can be mobilized or self-motivated to bring collective action and/or social or political pressure around an area of

common interest. CNDE enables commanders to understand the civil component of the OE. The effects of CNDE include—

- Enabling freedom of movement and maneuver.
- Managing limited resources.
- Preserving combat power.
- Providing the command with options to find, disrupt, and defeat threats in the civil component such as—
 - Destabilized or failing infrastructure.
 - Enemy special purpose forces.
 - Enemy proxy forces.
 - Criminal entities or unidentified adversaries who aim to create civil strife.
- Consolidating gains.

CIVIL KNOWLEDGE INTEGRATION

1-19. **Civil knowledge integration** is the actions taken to analyze, evaluate, and organize collected civil information for operational relevance and informing the warfighting function. The resulting civil knowledge is integrated with other knowledge about the OE to create shared understanding among commanders, unified action partners, international organizations, and civilian partners. CA forces use CKI primarily to inform, focus, direct CAO and civil-military operations (CMO) at all echelons.

1-20. In addition, CKI—incorporated through the Army’s integrating processes of intelligence preparation of the battlefield (IPB), information collection, targeting, risk management (RM), and knowledge management—enables the commander’s understanding of the OE and develops the common operational picture. CA units also use this information as inputs to the CNDE process to refine information requirements and to shape branches, sequels, and other future missions.

CIVIL-MILITARY INTEGRATION

1-21. **Civil-military integration** is the actions taken to establish, maintain, influence, or leverage relations between military forces and indigenous populations and institutions to synchronize, coordinate, and enable interorganizational cooperation and to achieve unified action. CMI is essential to effective integration of operations with commanders and unified action partners to achieve unity of effort. The establishment of a civil-military operations center (CMOC), or other mechanisms, enables civil information sharing and integration.

Note: See JP 3-08 for additional information about interorganizational cooperation.

CIVIL AFFAIRS MISSIONS

1-22. Execution of the CA missions allows CA forces to fulfill their role of engaging, influencing, and leveraging the civil component of the OE while enhancing, enabling, or providing governance. These missions are executed throughout all the core competencies and provide continuity in CAO.

1-23. CA missions include—

- Conduct civil reconnaissance (CR).
- Conduct civil engagement (CE).
- Conduct civil network development (CND).
- Conduct civil information evaluation (CIE).
- Establish CMOCs.
- Provide support to civil administration (SCA).
- Establish and maintain transitional military authority.

CONDUCT CIVIL RECONNAISSANCE

1-24. CA forces conduct CR across time and space in response to specific information requirements of the OE. This enhances the situational understanding and decision making of the supported commanders. CR is a targeted, planned, and coordinated observation and evaluation of specific civil factors in the OE. CR strives to consider the human, physical, and information dimensions of the OE. CR is conducted systematically over time to observe certain civil factors through the use of—

- Routine engagement.
- Patterned civil observance.
- Active, passive, and virtual sensors.
- Unmanned mobility systems.
- Other means to support assessments, measures of performance, and measures of effectiveness.

1-25. CR is executed throughout all CA core competencies. This is necessary for CA to effectively fulfill its roles of—

- Engaging and leveraging the civil component of the OE while enhancing, enabling, or providing governance.
- Providing input to the commander's information requirements.

CONDUCT CIVIL ENGAGEMENT

1-26. CA forces conduct deliberate or spontaneous CE with individuals or entities. CE is more effective when there is continuity between different CA elements and USG entities in the same AO. CE is critical to CNDE because the civil information and data collected during CE is analyzed, converted into civil knowledge, and integrated into the CNDE processes. CE is designed to—

- Establish or build relationships.
- Understand, promote, or enhance capability.
- Understand and create stability.
- Gather, confirm, or deny information related to subversive efforts and threats within the civil component.
- Foster legitimacy or promote cooperation and unified action.

1-27. CE, as an investment of resources, provides access to the individuals and groups that can be leveraged to support military operations. As an investment of resources, it also reduces the need to apply military resources against problem sets that belong to local, provincial, or national civil authorities. CE is executed throughout all CA core competencies. It is also necessary for CA forces to effectively fulfill their role of engaging and leveraging the civil component of the OE while enhancing, enabling, or providing governance.

CONDUCT CIVIL NETWORK DEVELOPMENT

1-28. ***Civil network development*** is the planned and targeted action in which Civil Affairs forces develop networks within the civil component of the operational environment to influence populations and manage local resources in order to extend the operational reach, consolidate gains, and achieve military objectives.

1-29. CND enhances the commander's understanding of the civil component and legitimizes the U.S. mission. The most effective means of conducting CND is in person. Other means of conducting CND are acceptable depending on the authorities and the permissions granted. CA forces conduct CND to promote the relationship between military forces and the civil component and to develop partner civil networks. CND is primarily actioned under the core competency of CNDE, but is integral to TG and CMI, through enabling CA forces to fulfill their role of engaging and leveraging the civil component of the OE while enhancing, enabling, or providing governance.

CONDUCT CIVIL INFORMATION EVALUATION

1-30. CA forces identify civil information requirements as part of a commander's information collection requirements. CA forces conduct CND, CR, CE, and data mining; they also collaborate with IPI,

interorganizational entities, NGOs, and other government agencies to collect and process information that is needed for commanders and staffs to plan successful missions. Commanders and staffs evaluate civil information for operational relevance to inform feasible courses of action. This civil information analysis (and subsequent evaluation) is utilized throughout the core competencies to allow CA forces to achieve their role of engaging and leveraging the civil component of the OE while enhancing, enabling, or providing governance.

ESTABLISH AND MAINTAIN CIVIL-MILITARY OPERATIONS CENTERS

1-31. CA units, from the company through the Civil Affairs Command (CACOM), establish CMOCs, as required, to serve as a mechanism for integrating, coordinating, and synchronizing the efforts of U.S. forces with unified action partners and IPI. A CMOC is task-organized with CA and other enabling assets (such as military intelligence, engineer, military police, medical, and transportation assets) to meet specific mission tasks assigned to the CA element.

1-32. Commanders establish a CMOC to provide continuous and seamless integration, coordination, and synchronization between military forces and unified action partners with nonmilitary and civilian entities according to the commander's operations plan. CA forces conduct CMI to ensure that the integration, coordination, and synchronization of forces is conducted within the scope of the operational plan of the commander. CMI is different from CNDE. CMI, which is effected by the CMOC, is focused on ensuring all entities in the AO are informed and understand the commander's intent and the common operational picture. CNDE, however, is focused on the development of civil networks to support and provide capabilities or resources that enable the mission and desired end state of the commander.

1-33. The CMOC—in coordination with the S-9, G-9, and J-9 by echelon—is designed to share information, identify and distribute resources, and assist in the execution of CAO and CMO. This mission is primarily nested under the core competency of CMI, but is integral in TG, through enabling CA forces to fulfill their role of engaging and leveraging the civil component of the OE while enhancing, enabling, or providing governance.

Note: Chapter 2 provides more information on establishing a CMOC.

PROVIDE SUPPORT TO CIVIL ADMINISTRATION

1-34. ***Support to civil administration*** is assistance given by United States armed forces to stabilize or enhance the operations of the governing body of a foreign country by assisting an established or interim government. Through the execution of SCA, CA forces assist an established government or interim civilian authority to mitigate, prepare for, respond to, or recover from crisis; or support a reconstructed government in the aftermath of war. SCA supports the U.S. diplomatic, informational, military, and economic instruments of national power abroad and will often occur in coordination with DOS to implement the U.S. stabilization strategy. CA forces execute SCA to provide assistance to a governing body or civil structure of a foreign country, according to international agreements, as part of disaster response or following armed conflict. This fulfills their requirements for enhancing, enabling, or providing governance.

Note: See Chapter 2 for more details on SCA.

ESTABLISH AND CONDUCT TRANSITIONAL MILITARY AUTHORITY

1-35. *Transitional military authority* is a temporary military government exercising the functions of civil administration in the absence of a legitimate civil authority (FM 3-07). Under extreme circumstances (in which the host-nation government has failed completely, or an enemy regime has been deposed) the intervening authority has a legal and moral responsibility to install a transitional authority on behalf of the population. When military forces invade and occupy enemy territory, those forces may establish a transitional military authority and take the lead in the stability sectors.

1-36. A transitional military authority may draw assistance from experienced civilian agencies and organizations. These agencies and organizations have the expertise to establish a system of government that fosters the gradual transition to a legitimate host-nation authority.

1-37. CA forces enable transitional military authority as early as possible in consolidation areas by applying civilian sector expertise to those functions normally executed by a civil government. CAO planners prepare for operations requiring transitional military authority well in advance—in coordination with DOS—to transfer those responsibilities to another authority as soon as security and political conditions allow.

Note: Transitional military authority is described further in Chapter 2.

BRANCH CHARACTERISTICS

1-38. CA branch characteristics are complementary to Army and joint capabilities. Some branches may possess similar characteristics, but CA branch characteristics collectively allow for accomplishing the role of the branch. While the following branch characteristics apply to the branch as a whole, individual units may possess additional characteristics due to unique mission requirements. The CA Branch is—

- **Governance Oriented.** CA forces execute the functions of civil administration throughout CAO.
- **Civil Component Focused.** CA forces are the primary capability of the commander for the analysis and evaluation of civil considerations during military operations. They enhance the commander's situational understanding of the civil component.
- **Civil Network Engagement Focused.** CA forces engage IPI and unified action partners to establish and maintain relationships, civil networks, and communication channels in order to—
 - Gain access to civilian resources and information.
 - Develop comprehensive situational understanding.
 - Integrate civil capabilities and information.
 - Enable unity of effort.
- **Civil Knowledge Integration Focused.** CA forces collect, collate, process, analyze, and evaluate civil information to produce valuable and timely civil knowledge for integration and dissemination.
- **Culturally Attuned.** Through extensive predeployment study, network engagement, and, when possible, theater engagement, CA forces are aware of population demographics, cultural nuances, divergent world views, biases, prejudices, and stereotypes that affect both the civil component and military operations.
- **Diplomatically Astute.** CA forces understand the sensitive political aspects of military operations. They establish relationships with formal and informal influencers and carefully manage those relationships to achieve positive outcomes during diplomatically sensitive interactions.

BRANCH PRINCIPLES

1-39. CA principles provide comprehensive and fundamental rules—or assumptions of central importance—that guide how CA approaches and thinks about the conduct of operations and captures the broad and enduring guidelines for the employment of CA forces. CA forces are the critical capability that the commander uses to influence, synchronize, and deconflict military operations with regards to the IPI, unified action partners, and the interagency. CA branch principles are outlined below.

STABILITY IS A FRAMEWORK FOR CIVIL AFFAIRS OPERATIONS

1-40. CAO play an important role in supporting all Army operations—offense, defense, stability, and defense support of civil authorities (DSCA). The CA core competencies describe capabilities that support the six primary stability operations tasks, which are—

- Establish civil security.
- Establish civil control.

- Restore essential services.
- Provide support to governance.
- Support the economic and infrastructure development.
- Conduct security cooperation.

CIVIL AFFAIRS OPERATIONS FOCUS ON CONSOLIDATION OF GAINS WITHIN THE CIVIL COMPONENT

1-41. CA plays a vital role in preparing, planning, and executing courses of action that must be integrated with the overall consolidation of gains plan. CA forces develop and engage supporting civil networks to increase local governance capability. This ensures a sustainable security environment, which allows for a transition of control to legitimate authorities.

CIVIL AFFAIRS OPERATIONS EMPOWER LOCAL CIVIL NETWORKS TO INCREASE GOVERNANCE CAPACITY AND PRESERVE COMBAT POWER

1-42. Utilizing civil networks, CA forces build capacity that supplements or replaces requirements with regard to civil security, cooperation, and services. This control reduces the burden on U.S. forces to provide for the needs of the population. Without this capacity, a hostile civilian population, or subset of it, can threaten the operations of friendly forces and undermine mission legitimacy. A supportive civilian population and accompanying civil networks provide resources, freedom of maneuver, and information that facilitate friendly operations.

CIVIL AFFAIRS OPERATIONS ARE AN INFORMATION-RELATED CAPABILITY

1-43. CAO involve direct interaction with IPI and unified action partners for the collection, collation, and dissemination of civil information. They are a capability employed in the information environment to create and/or assess effects, and shape operationally desirable conditions.

1-44. CA forces enhance and enable information operations (IO) by identifying civil aspects of the information environment, assessing and evaluating civil indicators of IO effectiveness within the AO, and providing actionable options to the supported commander's IO plan regarding themes and messages. CA forces complete these actions and provide support to IO through the conduct of CAO. CAO are an information-related capability.

A COMPREHENSIVE, INTERRELATED KNOWLEDGE BASE IS AN INVALUABLE ASSET

1-45. CA forces collect civil data for analysis, evaluation, and transformation into actionable civil knowledge within the operational area. This base of civil knowledge is available and leveraged for integration into all Army planning processes and warfighting functions. It is also critical for understanding civil component trends, predicting civil impacts on military missions, predicting military impacts on the IPI, and identifying threats within the civil component of the OE.

REGIONAL AND CULTURAL UNDERSTANDING ARE ESSENTIAL TO SUCCESSFUL CIVIL AFFAIRS OPERATIONS

1-46. CA forces rely on CE, relationships, and an understanding of the civil component to effectively plan and execute CAO. Regional and cultural competencies are critical skills for interacting with people of different cultures. Also essential to success are the knowledge and understanding of the interests, functions, capabilities, and vulnerabilities of the populations, institutions, and government apparatus that reside or operate in the region in which military forces operate.

CIVIL AFFAIRS OPERATIONS ARE NESTED WITH UNIFIED ACTION

1-47. Unified action requires the synchronization, coordination, and/or integration of the activities of governmental and non-governmental entities with military operations to achieve unity of effort. Each of the CA core competencies inherently supports these requirements by bringing military and civil capabilities

together in formal and informal ways to achieve common objectives. Early integration of CA forces into plans, operations and campaigns is critical to freedom of action, reduces operational friction, and enables unified action at the onset of military operations.

CIVIL AFFAIRS FORCES ARE CRITICAL AND ADAPTIVE THINKERS

1-48. CA forces are self-directed, self-disciplined, self-monitored, and self-correcting in their ability to apply the elements of thought (and the Army's problem-solving process) to the topics, situations, problems, and opportunities they encounter. When confronted by unanticipated circumstances during the execution of a planned military operation or event, they can make adjustments within the context of the plan to either exploit the advantage or minimize the impact.

This page intentionally left blank.

Chapter 2

Civil Affairs Operations

The DoD must maintain a capability to conduct a broad range of civil affairs operations necessary to support DoD missions and to meet DoD Component responsibilities to the civilian sector in the operational environment across the range of military operations.

DODD 2000.13, *Civil Affairs*
15 May 2017

This chapter provides an overview of the civil component and then provides a detailed breakdown on the core competencies and missions nested within CAO to give supported commanders a better understanding of the capabilities that CA forces provide during operations.

OVERVIEW

2-1. *Civil affairs operations* are actions planned, coordinated, executed, and assessed to enhance awareness of, and manage the interaction with, the civil component of the operational environment; identify and mitigate underlying causes of instability within civil society; and/or involve the application of functional specialty skills normally the responsibility of civil government (JP 3-57).

2-2. Army CA forces have the strategic objective of establishing and maintaining a secure and stable OE that is consistent with U.S. interests. In order to achieve their strategic objective, Army CA forces execute CAO across the range of military operations to—

- Engage and leverage the civil component (people, organizations, and capabilities) in order to enhance, enable, or provide governance.
- Increase situational understanding.
- Identify and defeat threats within the civil component.
- Consolidate gains.

THE CIVIL COMPONENT

2-3. The civil component consists of the populations, political institutions, infrastructure, economic capabilities, public and private civilian resources, and other features of the OE that are tied to the geographic areas and exclusive of the military apparatus of those areas. The civil component of the OE is largely consistent throughout the competition continuum. The civil component exists in the OE before, during, and after all conflicts. As such the civil component of the OE contains many capabilities, threats, and internal vulnerabilities that could affect the mission.

CAPABILITIES

2-4. The civil capabilities found within an OE depend on factors related to the IPI, government institutions, foreign actors, and natural resources encountered in specific geographic areas. The capabilities and associated resources are internal to all countries and allow for the support of a functioning society. Through proper coordination, U.S. and partner forces work locally to integrate capabilities within the commander's plan. Capabilities include, but are not limited to, those unique to individual areas and—

- Economic outputs.
- Communication infrastructure.
- Transportation infrastructure.
- Local resources.

- Civil network capabilities.
- Information sharing architecture.
- Government capacity.
- Political and social structures.

2-5. It is the role of the CA elements and CAO staff to identify and plan for the integration and protection of civil component capabilities within the commander's plan. CA staff, at all echelons, analyze civil component capabilities from two distinct perspectives, the degree to which civil component capabilities can—

- Sustain civilian security activities without the introduction of U.S. military or civilian resources.
- Be leveraged to support U.S. military or civilian objectives.

2-6. CA analysts continuously update the status of civil capabilities during operations as conditions change or as new threats to stability emerge. This analysis feeds into planning of military and civilian operations across the competition continuum.

THREATS

2-7. The civil threats found within an OE are primarily related to the threats to civil security. Civil security takes into consideration the factors of economic, food, health, environmental, personal, community, and political security. Threats within the civil component take many forms. These include, but are not limited to—

- Persistent poverty, unemployment, and lack of opportunity.
- Hunger and famine.
- Deadly infectious diseases, unsafe food, and malnutrition.
- Lack of access to basic health care and clean water.
- Environmental degradation, resource depletion, and natural disasters.
- Physical violence, crime, terrorism, domestic violence, and child labor.
- Interethnic, religious, and other identity-based tensions.
- Political repression and human rights abuses.
- Criminal elements.
- Destabilized or failing infrastructure.
- Elements aimed at fomenting societal collapse.
- Enemy special purpose forces.
- Propaganda, deception, misinformation, and disinformation.
- At-risk populations.
- Other elements or conditions that could lead to a breakdown of society.

2-8. Most threats target social structures within the civil component to destabilize the area. That destabilization can be used to take advantage of the population or to target U.S. and partner forces maneuvering through (and working within) the civil component.

2-9. Identification and reduction of threats is key to operational success within the civil component. The existence of any of these threats to the civil population within an OE is an inherent threat to U.S. military and civilian organizations operating there. Some of these threats may be created or exploited by adversaries specifically to destabilize an area to promote threat objectives or hinder the achievement of U.S. or ally objectives.

2-10. The key to defeating these threats is the promotion of local stabilization and governance capabilities and resources that are developed and leveraged from the CNDE processes. CA elements and staff, at all echelons, working with interorganizational partners, fully identify threats and potential threats before, during, and after military operations. CA commanders are responsible for continuous planning, coordination, and integration of civil and military resources to counter those threats across time and space in the competition continuum.

VULNERABILITIES

2-11. Civil vulnerabilities are those elements within a society that could be exploited by a threat actor or degraded by a natural event. In any given OE, there are specific, pertinent components that drive power

dynamics, which can be exploited by external powers as openings to gain access and leverage into a society in order to influence that society.

2-12. The civil vulnerabilities found in an OE depend on a several factors related to resilience. These vulnerabilities are often associated with the ability of populations, government institutions, and foreign actors in the OE to mitigate, prepare for, respond to, or recover from one or more of the typical threats to civil security as discussed above.

2-13. Vulnerabilities vary based on the degree of stability that exists within the specified geographic area (particularly the degree of stability afforded by levels of civil security, civil control, essential services, and critical infrastructure). Lack of resources, lack of public confidence and support, and the activities of internal and/or external individuals or groups who intend to exploit existing vulnerabilities pose great challenges to those responsible for transitioning to governance or maintaining governance.

2-14. CA forces, at all echelons, identify, classify, and propose courses of action to reduce vulnerabilities and leverage strengths within the civil component that could affect the overall mission completion. CA forces accomplish this through CND, CR, and CE. These mission tasks are focused by the civil information collection plan.

2-15. CA forces (working with interorganizational partners, IPI, unified action partners and other government entities) will attempt to fully identify the vulnerabilities or potential vulnerabilities. Once military operations begin, CA forces—using all of their core competencies—will continue to identify civil vulnerabilities and strengths within the OE. When large-scale combat operations end, CA forces will execute TG, transferring the OE over to appropriate civil authorities. Once this transition to SCA is complete, CA forces will partner in DOS-led U.S. stabilization efforts to identify civil strengths and vulnerabilities in targeted operational areas during competition before they impact the security of the U.S., its allies, and its partners.

CORE COMPETENCIES

2-16. The CA branch provides four core competencies nested within CAO. CA forces may execute competencies prior to, simultaneously with, or in the absence of other military operations across the conflict continuum and throughout the range of military operations. The CA core competencies are mutually supporting. The missions nested under the core competencies are capabilities executed to accomplish the designated role of the branch. The CA branch has the overall responsibility to perform these missions to—

- Enable the commander to visualize the common operational picture.
- Consolidate gains.
- Extend the culminating point.
- Identify civil resources and capabilities.
- Understand the civil component of the OE.
- Produce effects in the civil component of the OE.
- Synchronize, coordinate, and integrate civil knowledge into the warfighting functions and other Army processes.

TRANSITIONAL GOVERNANCE

2-17. The introduction of foreign military forces into sovereign territories often has a destabilizing effect on the integrity of local governance structures and their ability to control activities within defined political boundaries. When U.S. forces deploy to remove threat forces from a friendly country (or to defeat the security forces and governance structures of a belligerent country or non-state actor) they must be prepared to assume certain governance responsibilities over newly liberated or occupied territories until those responsibilities are able to be transferred to another authority. In DODD 5100.01, this military government requirement is listed as the sixth of thirteen specific functions of the Army. In turn, DODD 2000.13 requires the DOD to maintain a capability to provide expertise in civilian sector functions that normally are the responsibility of civilian authorities.

2-18. According to NSPD-44, while the DOS has the lead for stabilization and reconstruction, the DOD has a requirement to support that effort. DODD 5100.01 directs the Army to establish military government when

occupying enemy territory, and DODD 2000.13 identifies military government as a directed requirement under CAO.

2-19. Within its capabilities, and in accordance with international law, the occupying force must maintain an orderly government in the occupied territory and must have, as its ultimate goal, the creation of a legitimate and effective civilian government.

2-20. CA forces conduct TG to assure appropriate control and the continuation of government functions during times of destabilization. CA forces assure the effective transition of governance from civilian control to military control and then back to civilian control as smoothly and efficiently as possible. All CA missions are essential to proper execution of TG, but TG has two primary missions, which are—

- Provide transitional military authority.
- Provide SCA.

2-21. These missions give the Army the capability to better understand its military government role and to execute the legal responsibilities to the residents of liberated and occupied territories defined by international law and, specifically, the *1954 Hague Convention for the Protection of Cultural Property in the Event of Armed Conflict* and the *1899 Convention for the Pacific Settlement of International Disputes*. DODD 5100.01 mandates that the DOD maintains the capability to conduct military government operations. The DOD supports this mandate through TG.

2-22. CA forces providing TG use CMI, and the developed civil networks within the AO to support the establishment of SCA or transitional military authority that will enable the accomplishment of U.S. military objectives. SCA and transitional military authority support the whole of government approach and U.S. diplomatic, informational, military, and economic instruments of national power abroad through execution of governance tasks mandated by U.S. policy and international law.

GOVERNMENT EXPERTISE

2-23. CA forces have two distinct areas of expertise which are interrelated:

- Governance.
- Government functions.

2-24. *Governance* is the state's ability to serve the citizens through the rules, processes, and behavior by which interests are articulated, resources are managed, and power is exercised in a society (JP 3-24). Governance speaks to the administration of control by authorities exercising the role of the government. Government functions, however, refers to the structure that is used to conduct governance. That structure includes all the public systems used to create laws, administer justice, provide essential services, and maintain order. Expertise in government functions, therefore, is an expertise in those systems. Expertise in governance, however, is an understanding of how those systems are related and utilized to provide for the needs of a population.

Governance

2-25. Officers and noncommissioned officers provide governance expertise, while government function specialties within CA formations are the vehicle for the provision of government function expertise. Further, commanders and unified action partners have access to governmental sector expertise in the form of government function specialists, who have extensive civilian experience in provision of specific civil sectors.

2-26. CA forces provide TG expertise to military commanders to enable and enhance options for interacting with and influencing civil populations and institutions. CA forces execute TG through understanding the civil factors throughout the competition continuum. These civil factors include, but are not limited to—

- Security.
- Justice.
- Reconciliation.
- Humanitarian assistance.
- Social well-being.
- Governance and participation.

- Economic stabilization.
- Infrastructure.
- Culture.

2-27. CA responsibilities to enhance, enable, and provide governance include—

- Developing monitoring and evaluation plans for TG.
- Providing government function specialists.
- Developing civil networks, as necessary, to provide resources, capabilities, and expertise within the stability framework to assist in stabilizing the OE.
- Providing instruction, mentorship, and expertise to newly formed government agencies, as required.
- Assisting in the development of predictive analysis about government and civil sectors.
- Developing and updating running assessments of relevant civil networks (which include features, composition, and structure).
- Advising military commanders on civil impacts to military operations and impacts of military operations to the civil component at echelon.
- Advising military commanders on integration of CAO and civil network capabilities into military plans and operations.

Government Functions

2-28. CA force structure contains civil sector expertise within each of the focus areas, which fall under the five government function specialty areas (depicted in figure 2-1). Technically qualified and experienced individuals, known as CA government function specialists, advise, enable, and assist commanders and their direct civilian counterparts with stabilizing and providing governance expertise for the OE until appropriate civilian control is possible. Within their area of specialization, they possess the critical skills necessary to establish, support, or reestablish capability and capacity, as well as understand the regional and local impact of culture on that capability.

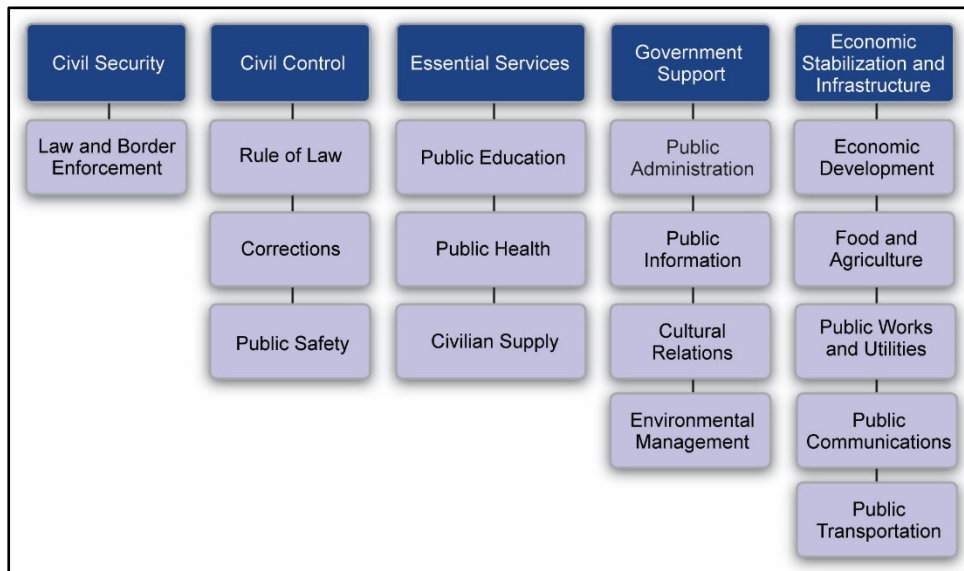


Figure 2-1. Government function specialty areas and focus areas

Note: Appendix B provides a detailed description of each focus area.

2-29. The preponderance of government function expertise capability is maintained within the United States Army Reserve, while a minimal capability comprised of the other Army government function specialist capabilities resides within the active component CA formations.

2-30. Depending on the OE in which CA units perform TG, the missions conducted to accomplish TG are distinct, complementary, and performed with varying levels of frequency, magnitude, and concentration. CA forces provide expertise in civilian sector functions and stability function tasks that are normally the responsibility of civilian authorities in order to establish or improve local government capability, or to perform military government functions until necessary conditions are established. The goal for TG is to return governance control to the appropriate civil authorities as soon as possible. CA forces executing TG provide, enhance, and enable—

- The conduct of governance.
- Building capabilities and capacity.
- Administrative control.
- Sustainability.
- Resources development.
- Transition of the AO to civil control.

2-31. Figure 2-2 illustrates the implementation of TG across the competition continuum.

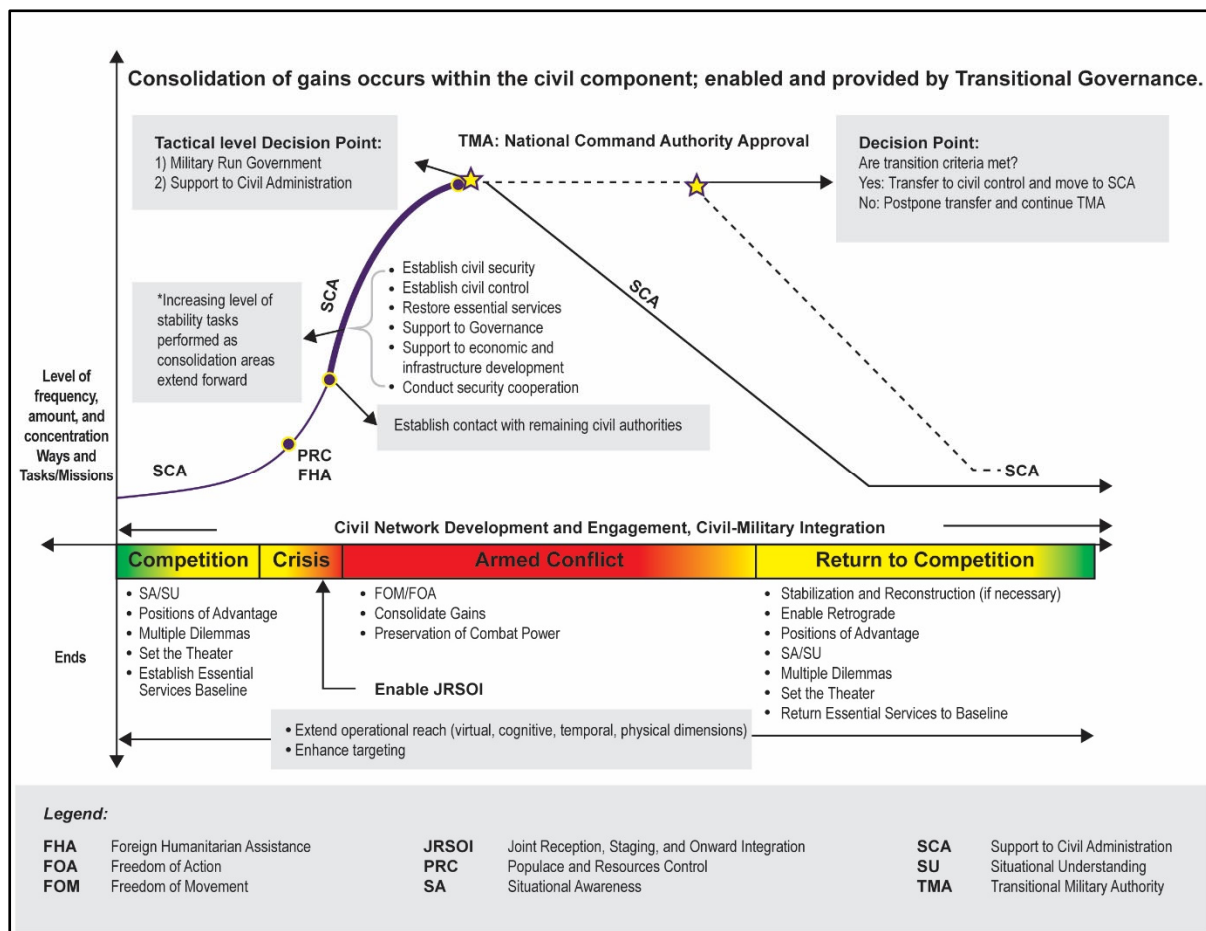


Figure 2-2. Transitional governance across the competition continuum

2-32. CA forces are trained, educated, and organized to provide commanders with governance expertise, support host-nation civil administration, and execute the functions of a civil administration. TG is enabled by the CA core competencies of CNDE, CKI, and CMI to effectively gain situational understanding, ensure CAO are achieving the desired end state of the supported commander, and assess effects in the civil component of the OE.

2-33. TG executed by CA forces can be different within the same AO or joint operations area based on mission requirements, the desired end states of the commander, and the capabilities and resources of the established local civil networks. At the operational level, CA units inside the theater of operations for large-scale combat operations may be conducting different TG requirements than CA units outside the theater of operations. At the tactical level, CA units in the division consolidation area may be at a different point on the SCA graph performing different missions than a CA unit in the corps consolidation area.

2-34. During the competition phase, CA units are primarily providing governance expertise to their supported military commander and conducting SCA to—

- Establish assessments of the civil component.
- Create situational understanding.
- Compete with adversaries to gain positions of advantage.
- Build partner capacity to deny freedom of maneuver or action to near peer adversaries.
- Set conditions in theater through persistent and episodic engagement.

2-35. As the joint force quickly transitions to armed conflict, CA forces mobilize civil networks and partners to enable joint reception, staging, onward movement and integration; populace and resources control (PRC); and FHA all in support of SCA.

2-36. During the commencement of offensive operations, CA units focus on establishing or reestablishing contact with civil authorities or civil networks. This enables situational understanding (which enhances the decision making of the commander), targeting, execution of effects, and reduction of civil interference (which preserves combat power). CA units can also be allocated or task-organized to engage, assess, and evaluate the civil components of bypassed population centers to begin the stabilization processes.

Note: These bypassed population centers must meet the bypass criteria established by the ground force commander.

2-37. CA forces engage, assess, and evaluate the civil components of bypassed population centers through building and mobilizing of friendly civil networks. These actions lead to preservation of combat power and extend the operational reach of the supported commander. As units establish area security and designate consolidation areas, the balance of tasks should shift more heavily towards stability operations tasks aimed at consolidation of gains and focused on the control of populations and key nodes. The primary stability operations tasks are—

- Establish civil security.
- Establish civil control.
- Restore essential service.
- Provide support to governance.
- Provide support to economic and infrastructure development.
- Conduct security cooperation.

2-38. The frequency, magnitude, and concentration of TG performed increases as consolidation area boundaries extend. The President has the authority to implement transitional military authority and the SecDef and joint forces commander exercise that authority. At the culmination of offensive operations (when transitional military authority is authorized) the commander must make the decision whether to exercise that authority or support a local civil administration that still has the capability to conduct governance.

2-39. The Joint Chiefs of Staff formulate broad policies and conduct initial planning for transitional military authority. However, CACOM commanders, CAO staff of combatant commanders (CCDRs), theater Civil Affairs planning teams (CAPTs), and CAO staff of Army Service Component Command should begin transitional military authority planning prior to the initiation of armed conflict.

2-40. If transitional military authority is exercised, CA commanders establish military government or provide advice and expertise to the commander and the governor. The commander and governor require this advice and expertise to exercise functions of civil administration until established transition criteria are met and/or until the arrival of the designated civil control transfer date.

2-41. If transitional military authority is not established, CA forces continue to provide SCA within occupied areas and gradually decrease the frequency, magnitude, and concentration of tasks performed as the civilian authorities increase capacity to levels prescribed by the stabilization plan of the DOS. The goal should always be to transition control to civilian authorities as soon as established local government is able to stand on its own and transition criteria are met.

Transitional Governance in Syria

After the liberation of portions of Northern Syria from Islamic State (IS) forces in late 2016, one thing was abundantly clear; if U.S. and Syrian Democratic Forces (SDF) were to consolidate operational gains it was imperative that governance be restored. For nearly two years IS had controlled the region, and the city of Manbij in particular, overseeing the normal functions of government such as essential services. Civil Affairs teams on the ground partnered with the Syrian Democratic Forces to initially identify specific priorities for stabilization and humanitarian efforts. Those priorities were relayed to DOS, USAID, and NGOs to begin the process of stabilization.

As the area became more stable and as IS fighters were increasingly pushed from the region, the reestablishment of government became a top priority. Civil Affairs teams advised and assisted the local population of Manbij in the creation of the Manbij Civil Council. The Manbij Civil Council was specifically formed with male and female membership representing all ethnic groups within the area. Once created the council began immediately the process of restoring essential services and partnering with the international community to establish work throughout the five USG stability sectors to bring economic and individual prosperity back to the region. The Manbij Civil Council was so successful that its model was copied numerous times throughout the region as IS was pushed further and further back. Manbij, in particular, became such a prosperous area that dislocated persons from across the country flocked to the city for a new start. From the beginning, Civil Affairs teams on the ground, partnering with local leaders, assisted in the transition towards inclusive and prosperous governance and stability for the people of Manbij and surrounding areas.

TRANSITIONAL MILITARY AUTHORITY

2-42. Under this authority, CA forces can provide TG to provide continuity of necessary government functions until they can be transferred to the appropriate civilian authorities. Transitional military authority enables commanders to achieve civil security and enable civil control and stability. The DOS has the lead on foreign policy and controls the majority of the resources which can be used under 22 USC. These resources are typically tied to achieving U.S. interests. Once an interim civilian government is established, military resources are engaged to provide SCA.

2-43. During transitional military authority, the following must exist:

- **Military Governor.** A military governor is the military commander or other designated person, who, in an occupied territory, exercises supreme authority over the civil population subject to the laws and usages of war and to any directive received from the government of the commander or another superior.
- **Military Government Ordinance.** A military government ordinance is an enactment on the authority of a military governor promulgating laws or rules, which regulate the occupied territory under such control.

2-44. CA provides transitional military authority through its commanders, governance expertise, and its government function specialist capabilities. All CA forces are skilled in governance and understand the importance of the five USG stability sectors to the implementation of governance at any level. These stability sectors are—

- Establish civil security.
- Establish civil control.
- Restore essential services.
- Provide support to governance.
- Provide support to economic and infrastructure development.

2-45. CA government function specialists have additional expertise within each of the USG stability sectors to facilitate governance. CA forces enable the continuity of government functions by providing a bridge to the more robust governance expertise of the DOS and other entities.

Note: See Appendix B for more detailed information on the role of CA in governance.

SUPPORT TO CIVIL ADMINISTRATION

2-46. SCA is a critical function of support to government operations, which is aligned with the six primary Army stability operations tasks. Support to governance is a stability operations task required for obtaining a stable population-centric OE. SCA is assistance given by CA forces to stabilize or enhance the operations of the governing body of a foreign country, by assisting an established or interim government. SCA occurs when CA forces support the DOS in the implementation of interim civil authority or U.S. foreign policy in support of host-nation internal defense and development.

Note: ADP 3-07 provides information on the critical aspects of SCA. Its discussion of movement corridors and personnel recovery provides guidance to CA forces when conducting these aspects of SCA.

Note: CA forces can gain a baseline understanding of an OE through several means, which include, but are not limited to, the reviews of current country studies by other CA forces and government entities.

2-47. During the competition phase, SCA can complement, support, enhance, and enable security cooperation, theater security cooperation activities, deterrence, foreign internal defense (FID), and CCDR campaign plans as a function of stability operations.

2-48. During armed conflict, SCA is implemented through execution of stability operations tasks. SCA is essential to consolidate gains that are made in offensive operations. In the close area, CA units establish contact with existing civil authorities and prioritize SCA efforts. As consolidation areas are established, U.S. forces will increase stability operations. Based on historical data from World War II liberation of occupied territories in the European theater, a typical sequence of events may look like—

- Dislocated civilian (DC) operations and FHA.
- Re-establishment of local government.
- Provision of emergency supplies.
- Public health and sanitation surveys.
- Organization and training of auxiliary police.
- Issuance of passes for necessary civilian travel.
- Liaison with resistance groups.
- Procurement of civilian labor for the Army.
- Assistance to Army in its relations with the civilian population.
- Restoration to nearly normal pre-conflict conditions.

Note: CA is critical to the planning, coordinating, and execution of the above tasks (and others) with civilian entities. These critical CA capabilities impact the commander's influence and use of command and control to consolidate gains within the OE.

2-49. The CA responsibilities during SCA in armed conflict are designed to enable the operational and support functions of the commander with respect to the continuity of government in a foreign nation or host nation (HN). Failure to consolidate gains leads to governance vacuums that will be exploited by adversaries.

2-50. In return to competition, if transitional military authority is not directed, CA units will continue to provide SCA while gradually transitioning to civilian authorities and decreasing SCA. Continued CMI will ensure SCA operations are synchronized with unified action partners.

2-51. CA responsibilities in SCA include—

- Monitoring and anticipating future requirements of the IPI in terms of the CA functional specialty areas.
- Engage and develop civil networks to facilitate TG requirements.
- Develop civil capacity and identify resources and capabilities to support the commander's mission.
- Coordinating and synchronizing collaborative interagency or multinational SCA operations.
- Execution of selected SCA operations.
- Performing quality control assessments of SCA operations and costs.
- Facilitating the arbitration of problems arising from the execution of SCA operations.
- Coordinating and synchronizing transition of SCA operations from military to indigenous government or international transitional government control.
- Targeting and prioritizing SCA with inputs from the CNDE process.
- Mobilizing civil networks to provide civil security and civil control.
- Mobilizing civil networks to enhance emergency management plans.

CIVIL NETWORK DEVELOPMENT AND ENGAGEMENT

2-52. The execution of CNDE enables commanders to develop courses of action that create effects in the civil component which consolidate gains and create multiple dilemmas for an enemy force attempting to act and maneuver through that area. Civil networks also enable commanders to assess the effects of IO and other nonlethal actions in the OE. CNDE and its associated tasks are critical functions of CAO. Supported commanders utilize CA forces to extend command and control influence where it is not normally present or established in order to leverage the civil entities within the operational area and achieve desired end states. CA forces conduct CNDE to enable the operations of the commander.

2-53. When developing and engaging civil networks, CA forces use rigor and diligence to ensure that civil networks are not threats (and do not become threats) to the civil component. Constant monitoring of these civil networks is critical to assess changes in motivation and loyalties. As CA forces identify civil networks within the AO, they categorize the civil networks, and provide them to the appropriate staff entity. For example, an identified threat network goes to the S-2, an identified sustainment network goes to the S-4, and a network that requires targeting goes to the S-3.

2-54. The CNDE process consists of the following six steps:

- Develop a civil network engagement plan.
- Conduct civil network engagement.
- Analyze civil networks.
- Develop selected civil networks.
- Evaluate developed civil networks.
- Integrate mobilized civil networks.

2-55. Step one of the CNDE process closely corresponds with the plan activity of the operations process. Steps two through six correspond to the execute activity of the operations process. Assessment is continuous

throughout all steps and is part of the overall assessment activity of the operations process. While figure 2-3 portrays a cyclical CNDE process, all steps may be executed simultaneously.

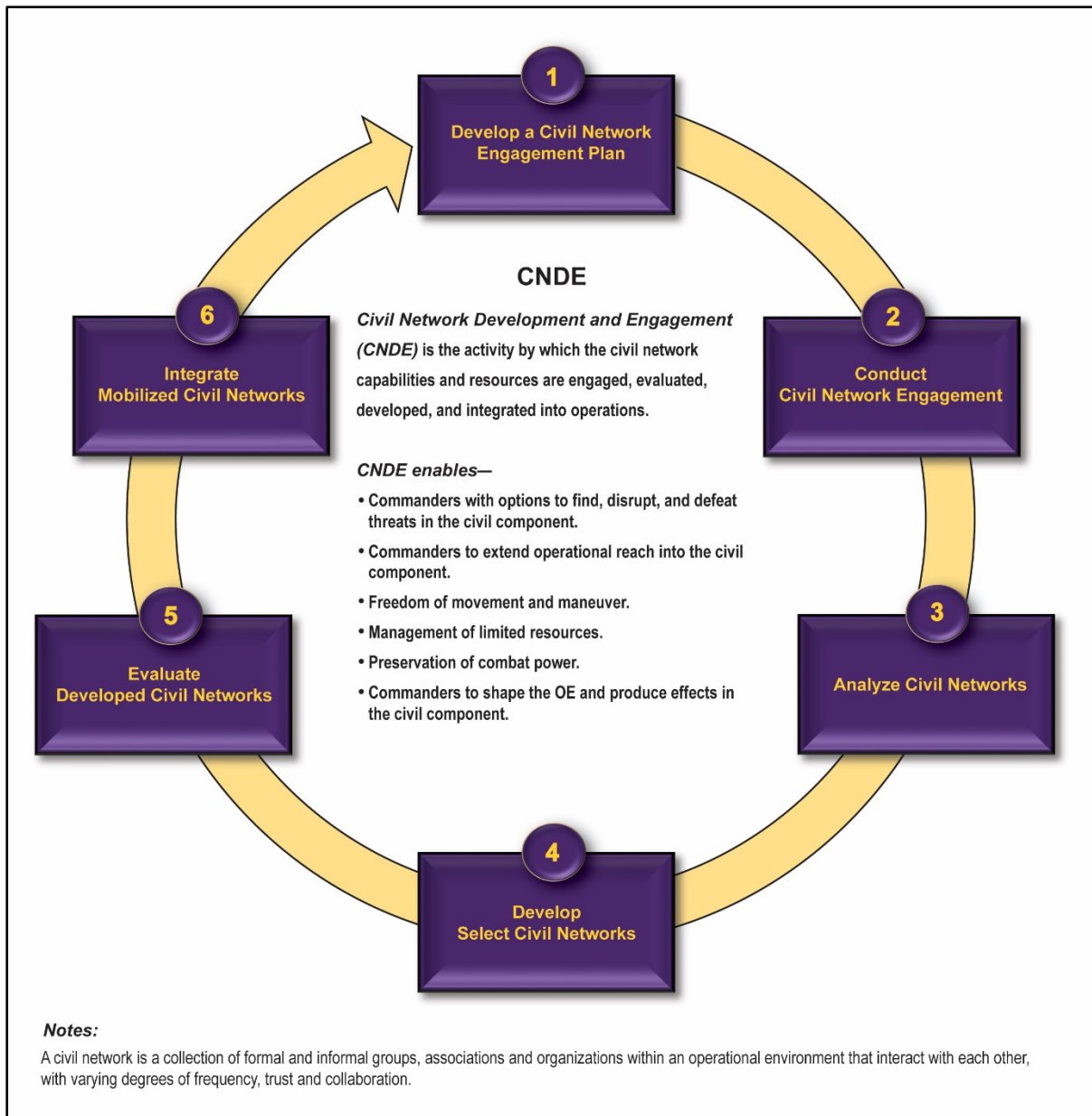


Figure 2-3. Civil network development and engagement process

DEVELOP A CIVIL NETWORK ENGAGEMENT PLAN

2-56. The civil network engagement plan organizes CA capabilities to address civil information requirements and civil resource requirements (including host-nation or foreign nation support). This plan is achieved through interaction and integration with civil networks for current or future operations in specific geographic areas. Civil information and resource requirements are derived from multiple sources which include, but are not limited to—

- Higher headquarters information and resource requirements
- Gaps in pre-deployment assessments and information databases.

- Commander's intent.
- Mission analysis.
- Commander's critical information requirements (CCIRs).
- Priority intelligence requirements of supported and CA unit commanders.
- Planned branches and sequels to combat operations, including consolidation activities and transition of governance activities to civil authorities.

2-57. CA forces (including individuals and teams) identify individuals, organizations, and existing networks of people who are able to provide civil information, produce desired effects, or fulfill resource requirements in the OE. CA forces are trained and required to develop new, or engage existing, civil networks within the civil populations, government and nongovernment organizations, the private sector, unified action partners, and others who reside or conduct business in and around the immediate AO.

2-58. The main outputs of this step include—

- A developed civil information collection plan.
- A CND plan to identify specific answers to CCIRs and targeting identification.
- A mission order or concept of operations (CONOPS) that directs targeted CR and CE that answers all information resource requirements.
- Civil network identifications in an area study.
- The use of initial or deliberate assessment and surveys of identified civil networks to confirm critical civil information.

2-59. Other outputs include, but are not limited to—

- Updates to the CA running estimate.
- Identification of additional mission tasks to be executed.
- Purpose.
- Objective.
- Effects.
- Measures of performance.
- Measures of effectiveness.

2-60. All these outputs, once analyzed and evaluated, provide civil knowledge that will be integrated by CAO staff, at echelon, into the command's planning processes. This information will be used to update the common operational picture through knowledge management and inform the warfighting functions as necessary.

2-61. CA forces work with other information-related capabilities to plan, prepare, execute, and assess communication activities. CNDE is used to understand and shape the information environment to create effects in the cognitive dimension that support information dominance and freedom of action. CA forces coordinate and synchronize objectives, effects, measures of effectiveness, and measures of performance with the other information-related capabilities.

CONDUCT CIVIL NETWORK ENGAGEMENT

2-62. The key tasks in conducting civil network engagement are CR and CE. CA forces conduct CR across time and space to enhance the supported commanders' situational understanding and facilitate decisionmaking.

2-63. CR is a targeted, planned, and coordinated observation and evaluation of specific civil aspects of the OE for the purpose of collecting civil information. The civil information collection plan drives CR and CE to understand the following in order to enhance situational understanding and facilitate decision making—

- Impacts of the civil component on military operations.
- Impacts of military operations on the civil component.
- Development of assessments and running estimates.

2-64. The purpose of CR is to—

- Verify or refute civil information.
- Assess the OE.
- Locate, identify, survey, and observe areas, structures, capabilities, organizations, people, and events (ASCOPE).
- Detect and monitor changes in the civil component.

2-65. CR and CE enable the synchronization of the CA collection efforts with the commander's critical information requirements and specific requests for information through the operations process. The outcomes from CR and CE add to the understanding of civil considerations and ultimately become inputs to the common operational picture of the commander.

2-66. CR and CE are also conducted systematically over time to observe and assess certain civil aspects of the environment through routine engagement, patterned civil observance, utilizing active and passive sensors, virtual sensors, and other means to support assessments of effects, measures of performance, and measures of effectiveness.

2-67. **Civil engagement is a targeted, planned, and coordinated meeting with known or potential contacts in a civil network that is designed to develop or maintain relationships and to share or collect information.** There may be times when CEs are ad hoc or spontaneous—as with chance meetings with new members of a potential or existing network—but these meetings are also conducted according to a planned and rehearsed format designed to build relationships; enable partners and increase stability; collect, confirm, or deny information; foster legitimacy; and promote cooperation and unity of effort.

2-68. CA forces may conduct CE in conjunction with maneuver unit patrols, hold unified action partner meetings with local leaders, or conduct IO unit polls and surveys. All CEs can be conducted physically, or virtually if the conditions of the OE will not allow for a physical presence. CE is critical to fully understanding the key leaders and their desires, interactions, and intentions in the ever-changing conditions of the OE. CE is necessary to achieve accurate nodal analysis and identification of civil networks that have the greatest capabilities and resources to support the commander's operational plan. It also preserves combat power by enabling military forces to tap into civilian resources that otherwise go unnoticed or unutilized. Through targeted CE, civil networks could be influenced to mobilize civilian resources to support U.S. military objectives.

2-69. The inputs to this step include constructing or updating the civil information collection plan based on—

- Planned and targeted activities for engagements and information reporting requirements, such as—
 - CCIRs, which includes priority intelligence requirements and friendly force information requirements.
 - Named areas of interest.
 - Targeted areas of interest.
- CONOPS for CND, CR, and CE.
- An assessment crosswalk of—
 - Task.
 - Purpose.
 - Objectives.
 - Effects.
 - Measures of performance.
 - Measures of effectiveness.

2-70. These inputs include civil network information and possible answers to information requirements order to better understand and assess the OE, build partner capacity, enable unity of effort, enhance freedom of action, and/or disrupt threats. CA forces must integrate, collaborate, and synchronize with other information-related capabilities, unified action partners, host-nation entities, and sensitive activities in order to achieve the commander's lines of effort, desired effects and enable unity of effort.

ANALYZE CIVIL NETWORKS

2-71. CA forces and CAO staff analyze civil network information, which is gained through CND, CR, and CE, to have an improved understanding of the strengths, vulnerabilities, capabilities, and motivations of local civil networks. Through this analysis, commanders can better understand which civil networks in their AO are friendly, neutral, threatening, or unknown in nature. This detailed analysis and mapping of the civil networks allows commanders and primary staff entities to decide which networks to engage with and which networks to develop. The analysis of civil network information also allows for the identification of critical capabilities, critical requirements, and critical vulnerabilities of the civil environment to identify centers of gravity for more effective targeting, such as natural resources, transportation, power generation, and protected sites.

Note: For further information and discussion on the center of gravity, see ADP 5-0.

2-72. **Civil network analysis is a process that identifies and analyzes the relative importance and influence of nodes within a civil network through network visualizations and qualitative and quantitative analytical methods.** CA forces conduct civil network analysis (CNA) utilizing multiple methods of network analysis, which include, but are not limited to—

- Organization mapping.
- Nodal analysis.
- Network function analysis.
- Network template analysis.
- Critical factors analysis.
- Link analysis.
- Social network analysis.

2-73. CA forces collate, process, analyze, and disseminate this civil network information for integration into targeting and operations planning. CAO staff integrate this information into the operations process through CKI in order to increase the commander's and staff's understanding of the OE and to further refine options for the commander to extend the command influence or to produce desired effects in the civil component of the OE.

2-74. The output of this step is the identification of selected civil networks to be influenced, enhanced, enabled, and integrated into operations to support the commander's mission and update the common operational picture, increase shared understanding of the OE, create freedom of action, and/or disrupt threats directly or indirectly.

DEVELOP SELECTED CIVIL NETWORKS

2-75. CA forces develop civil networks following a detailed analysis of the strengths, capabilities vulnerabilities, and motivations of the civil entities that comprise a potential network. Development of these civil networks is coordinated with supported command's targeting and mission planning sections. CA forces select and develop civil networks to—

- Increase their capability and/or capacity for improved shared understanding and assessment of the OE.
- Enable maneuverability of Army forces.
- Export capacity building to other civil networks.
- Increase freedom of action for maneuver and maneuver support forces.
- Enable unified action.
- Disrupt threats.

2-76. Civil networks are developed through programs, activities, and directed themes and messages that either support a friendly or neutral network or disrupt a threat network. The goal of developing civil networks is to provide courses of action that preserve combat power, consolidate gains, conserve finite resources, provide freedom of maneuver to friendly forces, and/or deny the enemy freedom of maneuver and access to the civilian population.

2-77. Civil networks are developed through capacity-building efforts such as training and advising, or through projects aimed at building legitimacy. Formal governmental networks are aided through SCA activities and assistance as directed by the command. Building friendly networks facilitates freedom of maneuver for U.S. and partner forces. This enables initial contact with potential connecting nodes and streamlines transitioning networks between different CA elements. It is critical that the incoming and outgoing CA elements update each other on situational understanding and transfer critical civil information and knowledge. This prevents duplicate efforts by different CA elements and the misuse of finite resources. This passing of contacts must also occur during the transition between competition to conflict, and during the rapid movement of CA forces towards the advancing forward line of troops.

2-78. Inputs to this step include analysis of which civil networks are capable of, willing to, and committed to achieving the commander's stated objectives and creating effects. This also includes a CND or assessment plan through which CA forces (in conjunction with unified action partners) assess the civil networks' capability, willingness, and commitment to achieve objectives and create effects.

EVALUATE DEVELOPED CIVIL NETWORKS

2-79. Before, during, and after development, civil networks must be continuously evaluated based on the individual strengths, weaknesses, vulnerabilities, and motivations of the specific networks. Through development, civil network capabilities are increased, strengths are enhanced, and weaknesses are mitigated. Constant vetting is necessary for measuring and evaluating how and whether the direction and motivations of the developed civil network are in tandem with U.S. objectives. Civil networks developed to enable or provide governance must be continuously evaluated for appropriateness of action.

INTEGRATE MOBILIZED CIVIL NETWORKS

2-80. CA forces integrate established and developed civil networks with operations, thereby the influence of a commander into the civil component and assisting in achieving the commander's operational goals, end states, and campaign objectives.

2-81. CA forces integrate mobilized friendly civil networks to bring collective action, social pressure, or political pressure around an area of common interest in support of the commander's objectives. When military forces are required to assist in or execute governance, CA forces integrate and manage established civil networks to meet, enable, or enact governance requirements. Established civil networks have capabilities and resources that increase governance capacity and efficiency. This allows commanders to preserve combat power (rather than expending it conducting TG, for example during civil security) and use that combat power to achieve and maintain dominance within the AO.

2-82. By acting as sensors in the civil environment, friendly networks aid in providing early warning of threats and increasing shared understanding of the OE. When CA forces integrate civil networks with operations, this enables a commander's freedom of movement by—

- Facilitating joint reception, staging, onward movement and integration through civil administration.
- Preserving combat power.
- Consolidating gains through the actions of civil security and civil control.
- Minimizing negative and maximizing positive civil influences.

2-83. Neutral networks can be influenced to self-mobilize and provide passive support to U.S. presence and deny access to threat actors. Mobilized friendly and neutral civil networks are key to denying threat networks freedom of maneuver and access to the resources and capabilities of the IPI. Neutral civil networks are dependable recruiting bases in the civil environment to gain information on threats to the civil population. These mobilized civil networks—in conjunction with (PRC) measures—when integrated into operations by CA forces enable the commander to effectively allocate finite resources, create effects, and reduce operational friction during all phases of operations and throughout the competition continuum to reach mission end states and goals.

Note: Further discussion of PRC is available in Chapter 3 of this FM.

2-84. Once integrated into operations, CA forces utilize these civil networks to engage the OE and the information environment to—

- Increase shared understanding of the civil component of the OE.
- Increase freedom of action.
- Find, disrupt, and defeat threats in the civil component, both directly and indirectly.

2-85. When integrated with ongoing operations, these networks can extend the operational reach of the commander to access denied, politically sensitive, or normally inaccessible areas, thereby creating multiple dilemmas for an adversary force. The integration of these networks can increase the commander's ability to reach desired objectives within the AO and reduce operational risk to the force.

2-86. When feasible, these networks are developed and expanded during competition by CA forces. Under the control of a commander, the networks may be further utilized during large-scale combat operations to conduct CR and CE in their designated AO. These civil networks are developed to conduct the functions of government, assist in stability, or increase local civil capabilities and capacities. They may also function in areas where the commander and assigned forces do not have physical access.

CIVIL KNOWLEDGE INTEGRATION

2-87. CKI provides the commanders, staff, and unified action partners with accurate and timely civil knowledge to update the common operational picture, facilitate decision making, update Army processes, develop branches and sequels for current and future operations, and inform all warfighting functions. CKI is the process whereby civil information is collected, analyzed, and evaluated; processed into civil knowledge; and integrated into the planning processes of the supported element, higher headquarters, USG and DOD agencies, international organizations, and NGOs. The CA company is limited in its ability to conduct this process, but the CA company commander is able to request additional support and capabilities from higher commands to support these requirements. The CAO staff, at every echelon, supports the development of civil knowledge and its integration into the operations processes and mission planning requirements of the commander and staff to achieve situational understanding at that echelon.

2-88. The CAO staff, at each echelon, is responsible for integrating civil knowledge into the supported Army commands, processes, and warfighting functions. CAO staff integrate civil knowledge through the Army's knowledge integrating processes and through integration with unified action partners. CA forces, at all echelons, are focused on the collection of civil information and data by the civil collection plan. The civil collection plan is a product resulting from civil preparation of the battlefield (CPB) that directs CA forces to conduct CND, CR, or CE to identify gaps in the CCIR, resources and capabilities within the civil component, and identification of civil strengths and vulnerabilities. CKI enables the commander and staff to understand and visualize the OE more clearly and provide situational awareness for all elements in the OE. The integration of actionable civil knowledge provides the commander and subordinate unit commanders the ability to achieve decision superiority.

Note: Chapter 3 provides a more detailed discussion on CPB. Chapter 4 describes the process with which CAO staff integrates civil knowledge into supported commands.

2-89. CA forces are trained and organized to focus on the CCIRs related to the operational variables of political, military, economic, social, information, infrastructure, physical environment, and time (PMESII-PT) and civil considerations of the mission variables (mission, enemy, terrain and weather, troops and support available, time available, civil considerations [METT-TC]) in the OE. According to DODD 2000.13, this requires the DOD to maintain a capability to provide expertise in civilian sector functions that normally are the responsibility of civilian authorities.

2-90. CA forces provide the commander with expertise on the civil component of the OE through the collection and development of civil data and civil information into civil knowledge. Civil knowledge is then prioritized and integrated into the knowledge management, military decisionmaking process (MDMP), targeting, other operating processes, and warfighting functions of the command. This civil knowledge is

critical to the commander's understanding, visualization, and planning for permissive, uncertain, and hostile environments. Figure 2-4 depicts how data is converted to the achievement of understanding.

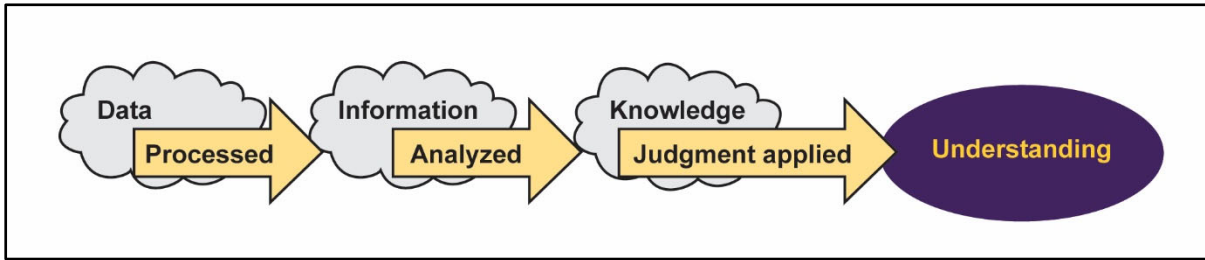


Figure 2-4. Achieving understanding

2-91. CA forces at all echelons collect civil data and information through the conduct of CND, CR, CE, and initial and deliberate assessments and surveys. The data collected provides current civil component information for analysis and evaluation through the CKI process. Civil considerations are analyzed and developed from civil knowledge with use of the framework of ASCOPE within the civil component of the commander's OE.

2-92. The six steps of the CKI process are designed to logically generate situational understanding by taking raw civil data from multiple sources, applying proven analysis techniques to the data, fusing the analyzed data with the intelligence and information systems of units, prioritizing and integrating the resulting civil knowledge at all military echelons and with unified action partners, and integrating civil knowledge. The CKI process is conducted in the following six steps:

- Develop a civil information collection plan.
- Collect civil data.
- Process civil information.
- Analyze and evaluate civil information.
- Produce civil knowledge products.
- Integrate civil knowledge.

2-93. This civil knowledge informs all warfighting functions to ensure synchronization with the civil component to reduce operational friction. This continual process ensures the timely availability of analyzed and evaluated civil information to military forces throughout the AO in order to—

- Enhance understanding of the common operational picture.
- Update CA running estimates.
- Inform all integrating processes.
- Update critical information pertaining to all warfighting functions at higher echelons of command.

2-94. CA forces should also actively incorporate the supported unit's information requirements into the civil information collection plan to enhance the common operational picture, the CA running estimates, and the IPB process through CKI. Every CA Soldier has the ability to conduct basic analysis and evaluation of civil information. CMOCs, CKI sections, and higher CA headquarters analysts conduct in-depth analysis and evaluation of that civil information as part of the process that enhances the situational understanding of the supported commander, staff, and unified action partners.

2-95. The six steps are depicted in figure 2-5, page 2-18.

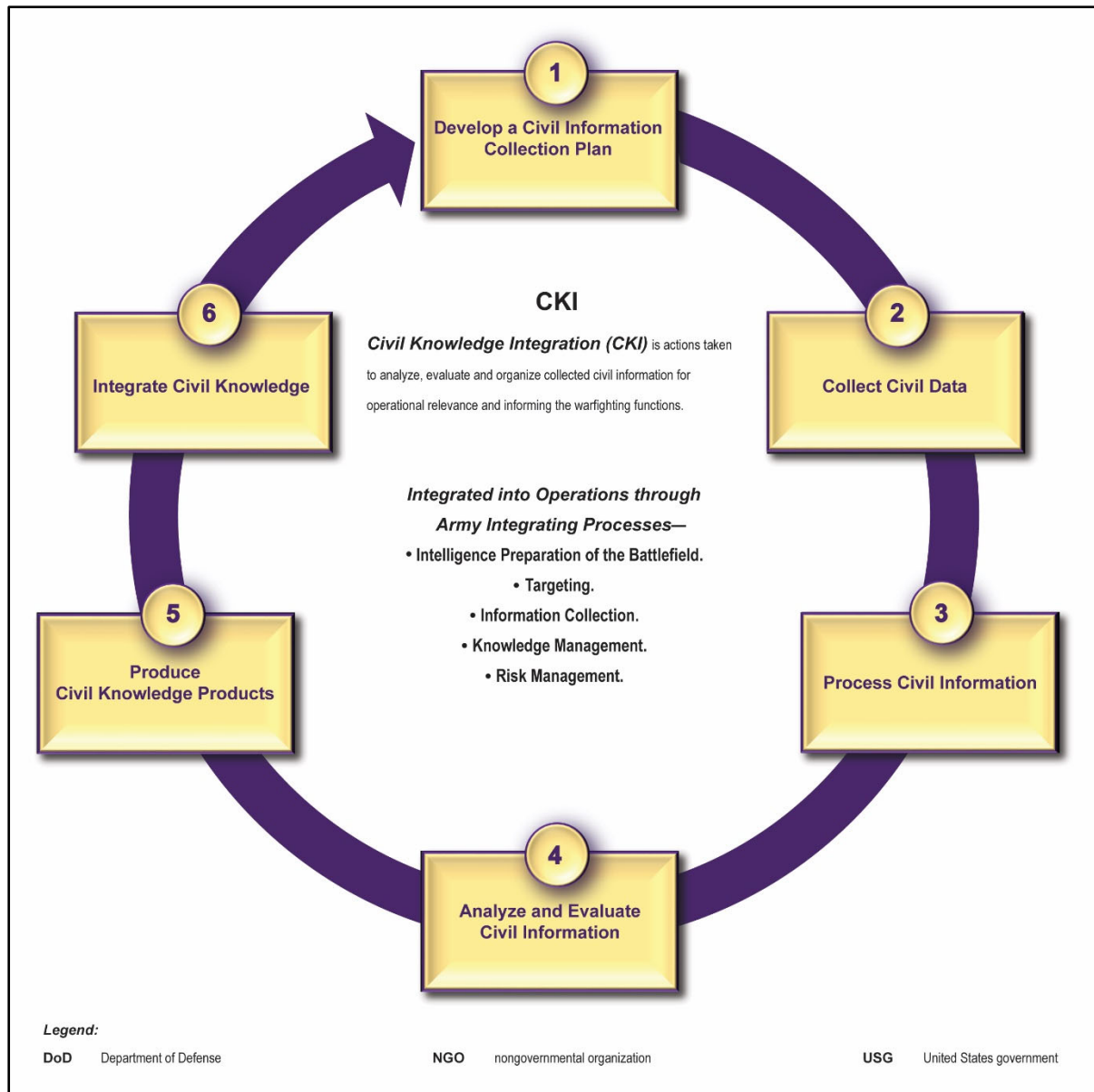


Figure 2-5. Civil knowledge integration process

DEVELOP A CIVIL INFORMATION COLLECTION PLAN

2-96. CA forces and staff identify specific requirements for civil information based on the commander’s need for a detailed knowledge of civil capabilities, strengths, vulnerabilities, organizations, and resources. A civil information collection plan is designed to identify specific CA elements to conduct CND, CE, and CR to collect civil information and data that is used to develop civil knowledge. CA planners

2-97. CA planners integrate the civil knowledge into current and planned CAO and Army operations processes and to inform the warfighting functions. The civil information collection plan initiates the process of achieving CKI which enables commanders and staffs to visualize the common operational picture and understand the civil component of the OE.

2-98. An effective civil information collection plan enhances the understanding of the OE and is translated (at the tactical level) into CONOPS and mission directives. The civil information collection plan must be cross-referenced with current understanding of civil networks and sources of information that currently exist within a

CA unit. Upon completion of cross-referencing and analysis, CA forces are assigned to conduct specific CND, CR, or CE missions to engage or reconnoiter for the information needed.

Collect Civil Data

2-99. CA forces collect civil data at all levels of operation through CND; CR; CE; data mining; and collaboration with IPI, interorganizational entities, NGOs, and other government agencies. The pertinent civil data ultimately will become civil knowledge that will be used to inform the common operational picture, assist in the commander's visualization of the battlefield, and inform the warfighting functions.

2-100. The heart of collection is the daily interaction between U.S. forces and the various civilians in the AO. The capture of these data points and the relevant contact information for each individual and entity is equally important. The collection of civil data ultimately provides the commander with knowledge of civil capabilities and resources that can be leveraged for military purposes. These leveraged capabilities and resources can help meet military objectives, build capacity during TMA, consolidate gains, and help establish civil control and civil security.

Process Civil Information

2-101. CA forces process civil information by collating civil data into groupings and then physically and mentally manipulating separate pieces of data into information. Processing structures the data into a usable form for analysis and evaluation. Processing focuses on information management, which is the science of using procedures and information systems to collect, process, store, display, disseminate, and protect knowledge products, data, and information.

Note: Chapter 4 provides an example of a PMESII – ASCOPE crosswalk, which is used to collate civil data.

Analyze and Evaluate Civil Information

2-102. CA forces analyze civil information for patterns and indicators of behaviors or trends that may have predictive value and application. That analysis is then evaluated, interpreted, and prioritized by CA personnel to assess, predict, validate, and determine the impact of ongoing operations on the mission of the commander. Analysis and evaluation molds civil information into civil knowledge.

Produce Civil Knowledge Products

2-103. CA forces package civil knowledge into easily disseminated products. Civil knowledge products and services are relevant, accurate, timely, and usable by commanders and staffs. These products are then disseminated to relevant partners, NGOs, interagency partners, or integrated into the Army operations process through the Army's integrating functions.

Integrate Civil Knowledge

2-104. CA forces integrate civil knowledge into the knowledge management, MDMP, targeting operations, and warfighting functions of the supported command. This process is generally conducted by CA personnel on the staff but is also completed by CA elements that have been integrated into the supported command's operations. This civil knowledge is critical to forming the common operational picture, and framing the commander's understanding, visualization, and planning for permissive, uncertain, and hostile environments.

2-105. If there is no CA staff assigned to the supported unit, the commander of the CA element (as allocated by echelon) is required to become that CA staff officer while maintaining the command relationship with the CA unit. Each CA unit, at each echelon, is required to ensure the command receives CA staff support.

Note: Due to the large number of interactions with local and host-nation partners, CA units require a significant investment in foreign disclosure training and training about assets that are authorized to conduct foreign disclosure.

CIVIL-MILITARY INTEGRATION

2-106. Successful military operations place an increased emphasis on civil considerations in order to achieve U.S. goals and objectives. By design, CA forces seek out and work with the civilian populations, private entities, government institutions, international organizations, NGOs, interagency, and multinational partners that reside or operate in and around an AO or area of interest. Bringing these capabilities and resources together under the influence of the commander and across the competition continuum, enables CAO to integrate, coordinate, and synchronize civil capabilities and resources within the area. CMI is the requirement of the CA force to incorporate the interests, functions, capabilities, and vulnerabilities of these nonmilitary groups into military plans and operations to enable unity of effort. CMI fosters unified action with the military force to achieve a desired outcome through the collaboration, integration, and synchronization of partner knowledge and capabilities.

Civil-Military Integration in Somalia

In 1992, Soldiers of the 96th Civil Affairs Battalion deployed to Somalia in support of Operation Restore Hope. Their primary mission was to conduct liaison between military commanders, local leaders, and members of NGOs. This was accomplished through the staffing of Humanitarian Operations Centers (HOCs) in Humanitarian Relief Sectors throughout Somalia. CA forces conducted medical and engineer assessments of facilities, coordinated medical and engineer civic action projects, and conducted liaison between military forces and local Somali communities.

Relations between the CA forces, NGOs, and local communities were generally positive in nature. The Somalis respected the CA function as liaison between military security forces and NGOs. This respect and access allowed for CA forces to better map and understand the factional dynamics and coordinate actions between NGOs, locals, and military elements.

2-107. There are two primary CMI actions that CA forces conduct within this construct. CA forces establish a civil-military information sharing architecture and establish a CMOC. These actions are executed exclusively by CA forces at all echelons, or by partner or allied forces augmented with properly manned and equipped CAO staff elements. Properly executed CMI—through the use of civil networks—increases shared understanding of the OE through information and knowledge transfer with unified action partners, preserves combat power through increased capacity of civilian administration, and consolidates gains through rapid stabilization efforts.

ESTABLISH CIVIL-MILITARY INFORMATION SHARING ARCHITECTURE

2-108. One of the most important actions to ensure CMI establishment is to create a civil-military information sharing architecture. CA forces establish a civil-military information architecture (that is, information exchange systems and processes) to share information between CA forces and applicable partners, such as—

- Developed or existing civil networks.
- Coalition forces.
- NGOs and governmental organizations.
- Host-nation governments.
- Elements of the private sector.

2-109. A well-defined and well-designed civil information architecture provides the best mechanism to support understanding of the civil component of the OE. The OE includes natural and human-made terrain; friendly, neutral, and threat elements among civil populations and government institutions; and the interactions between the civil populace and key terrain in the civil component. In austere environments, CA forces may have limited access to U.S. Army mission command systems, or even electricity. CA forces and staffs may adapt their civil information architecture to concepts that can be written in text or posted on white

boards for sharing with the HN and partners. Presentation of civil products is dependent on OE restrictions, such as no electricity or other restrictive conditions.

2-110. Information-sharing systems must use the lowest classification possible to ensure the widest distribution of information needed to coordinate with civilian agencies and organizations operating in the same operational area as military forces. During large scale combat operations, or in response to a disaster, the organic military information infrastructure enables CA forces to rapidly establish information-sharing architecture to store, integrate, and disseminate critical civil information. This is accomplished by tying local civilian entities into the military system or by providing data connections to civilian systems. This exchange of information increases the amount of information collected and supports an improved situational understanding, increased trust with other entities within the AO, unity of effort, and a more detailed common operational picture.

2-111. At the staff level this architecture is centered on the technology and population-centric systems used to manage and disseminate data with partners. Sharing this architecture is mainly done in a technological manner, but also includes people and processes as well. Placing liaison officers within participating government agencies and host-nation institutions, receiving liaison officers from other government agencies placed inside commands, and conducting scheduled information-sharing meetings and other interactions are key to achieving CMI.

2-112. Information-sharing architecture also includes working groups and coordination groups. The United Nations cluster system is an example of a coordination group and is a common system established to coordinate efforts following disasters. CA liaison officers assigned to participate in the United Nations cluster system (and other information-sharing platforms) should be empowered by their command to freely disseminate properly vetted and releasable civil knowledge products that are beneficial to the response effort. Liaison officers should be placed within other governmental organizations, such as the DOS or the United States Agency for International Development (USAID). In addition, liaison officers from organizations such as USAID and the DOS, should be placed in the command for seamless planning and coordination.

Note: For more information on the United Nations cluster system, see FM 3-07.

2-113. In large-scale combat operations, a supported CCDR might elect to establish a joint interagency coordination group or joint interagency task force tailored to meet the operational requirements of the combatant command. The joint interagency coordination group (or equivalent organization) provides the CCDR with the capability to collaborate, at the operational level, with civilian USG departments and agencies. The joint interagency coordination group (or equivalent organization) complements the interagency coordination that takes place at the national strategic level through the DOD, National Security Council, and Homeland Security Council systems. Members participate in deliberate planning and crisis action planning and provide links back to their parent organizations to help synchronize joint force operations with the efforts of civilian USG departments and agencies.

Note: Due to the large number of interactions with local and host-nation partners, CA units require a significant investment in foreign disclosure training and assets that are authorized to conduct foreign disclosure.

ESTABLISH AND MAINTAIN CIVIL-MILITARY OPERATIONS CENTER

2-114. Based on the operations plan of the commander, CA units (from the company through CACOM) establish CMOCs, as necessary, to serve as a mechanism for integration, coordination, and synchronization of the efforts of U.S. forces with unified action partners and IPI. A CMOC is task-organized with CA and other enabling assets (such as military intelligence, engineering, medical, and transportation) to meet specific mission tasks assigned to the CA element by the commander. The CMOC—in coordination with the S-9, G-9, and J-9—is designed to share information, identify and distribute resources, and assist in the execution of CAO. Figure 2-6, page 2-22, shows a notional CA CMOC configuration.

2-115. As an extension of mission command, the CMOC provides the supported commander the ability to integrate, coordinate, and synchronize the activities of stakeholders, which are not under command authority,

in an effort to enable unified action. This is a critical requirement in unified land operations during all phases of operations and across the competition continuum. The CMOC is critical in the integration, coordination and synchronization of CMI, CAO, and CMO in—

- Defense support to stabilization during competition.
- Joint reception.
- Staging onward movement and integration during transition to armed conflict.
- Consolidation activities, defense support to stabilization, and TG in rear areas (within transitional military authority or SCA, as appropriate) during armed conflict and return to competition.

2-116. During unified land operations conditions may shift from offense to defense to stabilization, and multiple conditions can exist simultaneously within an AO. CMOCs are an asset for the commander in their role of collecting, analyzing, and evaluating information from multiple sources to track and understand changing conditions. They can also play a role in planning future operations by integrating with stabilization focused departments, agencies, and organizations.

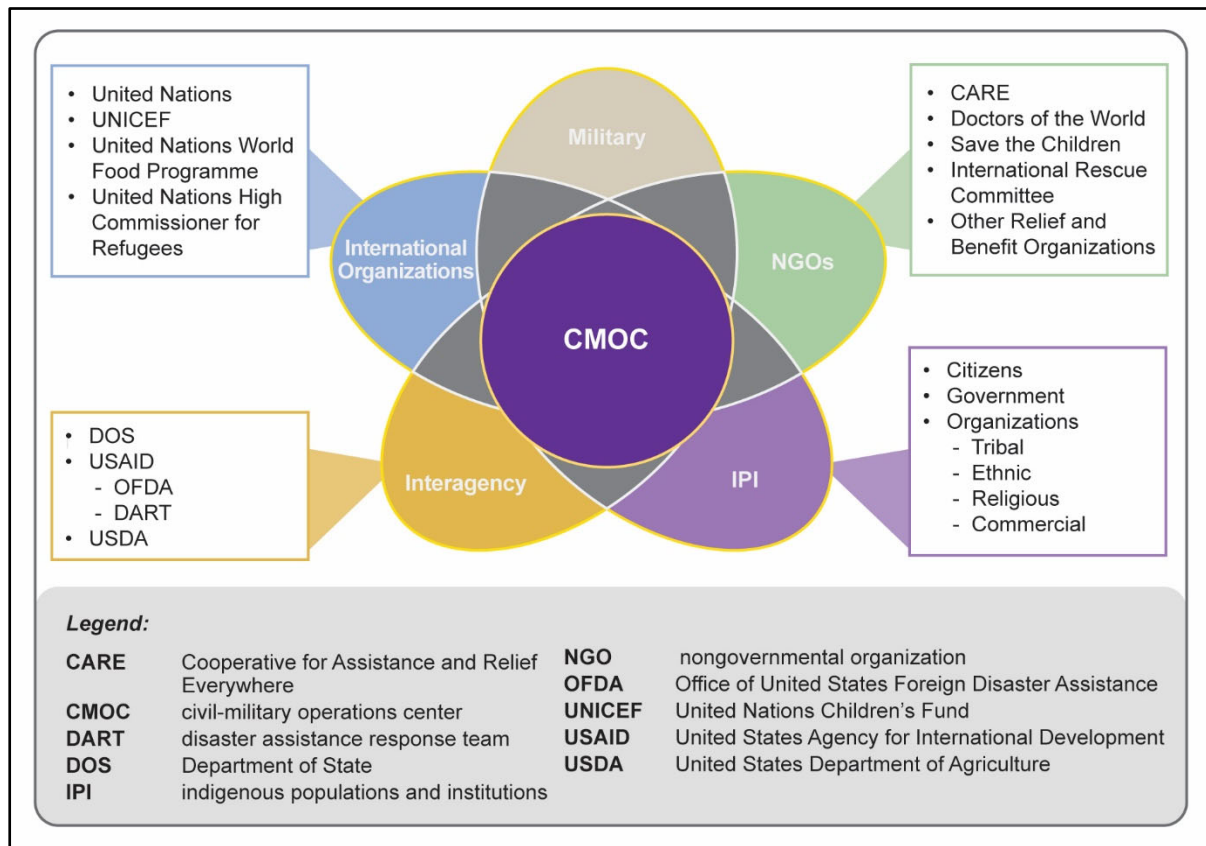


Figure 2-6. Notional Civil Affairs civil-military operations center configuration

2-117. During conditions that primarily favor offensive operations, CMOCs at the tactical level remain as mobile as the headquarters element. CMOCs—

- Provide information on resources within an OE that can assist the commander in achieving stated goals and end states, while reducing internal resource consumption.
- Plan populace control measures to increase freedom of maneuver.
- Plan CAO to increase stability in newly liberated areas, and liaises with joint, interagency, and interorganizational partners to prepare for the transition to stability operations.

- Generate broad-spectrum information regarding the civil component, which commanders use to develop an understanding of their OE.
- Support the commander and associated S-9, G-9, and J-9 staff elements by enabling consolidation of gains through planning and conduct of the minimum-essential stability operations tasks to establish civil security and provide immediate needs where they exist as a result of combat operations.

2-118. The ability of the CMOC to coordinate directly with local government is often limited to the tactical level. When coordinating with the local government, CMOCs initiate PRC measures, humanitarian assistance, stability operations tasks, and other stabilization activities designated by the commander. Coordination with the civil component (such as IPI, international organizations, NGOs) the private sector, and the interagency, is minimized given the urgency of defeating lethal threats.

2-119. During conditions that favor primarily defensive operations, CMOCs become static, much like the units they support. When static, CMOCs—

- Can focus on the civil conditions within a specific area.
- Increase the amount of civil information gleaned from civil network nodes and ground forces operating in the area, the longer the CMOCs remain static.
- During mobile defense, work to establish, maintain, or hand off communication with civil entities to ensure the planning for and conduct of minimum-stability tasks.
- Support the commander and associated S-9, G-9, and J-9 staff elements by enabling consolidation of gains through planning for and conduct of minimum-essential stability operations tasks to establish civil security and provide immediate needs where they exist as a result of combat operations.
- Coordinate with entities within the civil component (such as IPI, international organizations, NGOs, and the interagency) to—
 - Identify threats to the civil populace.
 - Execute TG.
 - Coordinate civil capabilities and resources to support the commander’s mission.

2-120. Developed and integrated civil networks allow the commander to maintain influence over those areas that might need to be bypassed or vacated during mobile defense. CMOCs also plan and direct minimum-essential stability operations where the need exists because of combat operations. During defense, coordination with civil components (such as IPI, international organizations, NGOs, and the interagency) is essential and urgent. This is due to the importance of defeating lethal threats within the civil component, and the need to rapidly and effectively consolidate gains to free resources for prosecuting the enemy in other areas of the OE.

2-121. CMOCs continuously plan for and reinforce stability during operations to enable consolidation of gains. During conditions where stability operations tasks prevail, a combination of offensive and defensive operations will continue, but in lesser proportion than support to stabilization. In such conditions, CMOCs—

- Gain the time necessary to establish and reestablish civil networks through CA units of action within the civil component.
- Plan for civil component assessments.
- Recommend initial procedures necessary for commanders to expand beyond the minimum-essential stability operations tasks and conduct the full range of stability operations tasks.
- Provide greater visualization of the civil component of the OE to the commander to enable effective mission planning.

2-122. CMOCs orchestrate assessments and recommend initial procedures necessary for commanders to expand beyond the minimum-essential stability operations tasks to conduct the full range of stability operations tasks. CMOCs plan and direct the implementation of PRC measures, SCA, FHA, and nation assistance to achieve stability in the civil component of an OE. Through the commander, the CMOC has the latitude and freedom of action (that is necessary during stability-oriented operations) to exercise all its capabilities. When fully operational, the CMOC provides commanders with greater visualization of the civil

component within an OE to achieve essential stability objectives through unified land operations via the execution of TG, CNDE, CKI, and CMI.

2-123. The CMOC, at each CA echelon, is manned and equipped with the same mobility, communications, and protection capabilities of its supported unit to facilitate quick and continuous interoperability in high tempo, mobile, and static operations. It is also capable of locating and configuring itself in multiple environments to facilitate the integration of, and interaction with, civilian partners who have varying degrees of mobility, communications, and protection capabilities of their own. Finally, the CMOC is capable of safeguarding the collection, storage, and transmission of sensitive or classified information in all operations.

Chapter 3

Unified Land Operations

If America's armed forces have fought fewer than a dozen major conventional wars in over two centuries, they have, during that same period, engaged in several hundred military undertakings that would today be characterized as stability operations.

*The US Military's Experience in Stability Operations, 1789-2005:
Global War on Terrorism Occasional Paper 15
Dr. Lawrence A. Yates*

According to ADP 3-0, unified land operations describes how the Army seizes, retains, and exploits the initiative to gain and maintain a position of relative advantage in sustained land operations through simultaneous offensive, defensive, and stability operations in order to prevent or deter conflict, prevail in war, and create the conditions for favorable conflict resolution. The goal of unified land operations is to establish conditions that achieve the end state of the joint force command by applying land power as part of a unified action to defeat the enemy.

This chapter details CA support to the Army's strategic roles as addressed through unified land operations and executed through decisive action. The strategic roles clarify the enduring reasons for which the U.S. Army is organized, trained, and equipped. Strategic roles are not tasks assigned to subordinate units nor are they phases. Strategic tasks should not be confused with the joint phasing construct. The civil population impacts every aspect of military operations. Failure to plan and failure to leverage the IPI within the OE will lead to failure of the military mission and failure to achieve the desired end state.

CIVIL AFFAIRS CONTRIBUTION TO OPERATIONS

3-1. The CA capability is vital to all operation types—across the competition continuum, in crisis or conflict—to achieve the required effects and the desired end states of the commander. Land operations disrupt routine life patterns of civilians who can dramatically impact military operations. It is critical for CA forces to be involved in the planning, development, and execution of appropriate civil controls. This protects civilians throughout military operations, reduces civilian casualties during consolidation of gains, and minimizes negative impacts on maneuver forces during large-scale combat operations.

3-2. In addition, large-scale ground combat often disrupts lines of communications and access to basic needs and essential services. There are few uninhabited places in which the Army is likely to fight so, Army forces must plan to conduct the minimum-essential stability operations tasks (providing security, food, water, shelter, and medical treatment) as an integral part of large-scale ground combat.

3-3. Before, during, and after large-scale ground combat, CA forces neutralize or disrupt adversaries by leveraging civil networks, resources, capabilities, and relevant populations. The civil knowledge derived from CNDE enables the situational understanding of the OE for the commander, enables visualization of the battlefield for the commander, and increases the lethality of the unit through targeting processes.

3-4. The Army generates CA forces to plan, direct, and execute CAO. Each CA unit and staff section applies the CA core competencies, which are nested within CAO, to virtual, cognitive, temporal, and physical operations across the competition continuum.

ARMY STRATEGIC ROLES

3-5. The Army accomplishes its mission by supporting the joint force with unified land operations, thus fulfilling the four strategic roles of—

- Shape OEs.
- Prevent conflict.
- Prevail in large-scale ground combat.
- Consolidate gains.

3-6. CA forces engage and leverage civil networks (people, organizations, and capabilities) to produce desired effects and defeat threats in the civil component. These support the strategic objective of establishing a secure and stable OE that is consistent with U.S. interests. CA forces support the Army's strategic roles by performing four core competencies of TG, CNDE, CKI, and CMI in support of unified land operations as executed through the elements of decisive action.

3-7. CA supports the strategic roles by—

- Conducting TG to improve and/or implement governance. This supports military objectives across the competition continuum—such as interagency-led stabilization efforts, or DOD-led endeavors in post-conflict or post-crisis environments. TG conducted by CA forces supports the whole of government approach as well as U.S. diplomatic, informational, military, and economic instruments of national power abroad through execution of governance tasks mandated by U.S. policy and international law. TG supports military objectives across the competition continuum.
- Providing commanders with options to find, disrupt, and defeat threats in the civil component; extending command and control; enabling freedom of movement and maneuver; and leveraging available resources in the civil component. This is accomplished by engaging civil networks to build friendly networks, influence neutral networks, classify unknown networks, and degrade threat networks.
- Integrating civil knowledge gained through CNDE, CR, and other information collection methods to enhance situational understanding for the supported commander, provide inputs to operations and targeting processes, and provide detailed mission planning to units at all echelons.
- Conducting CMI to establish, maintain, influence, or leverage relations between military forces, partners, IPI, and other non-military entities. This is done by directly supporting the achievement of objectives related to the reestablishment or maintenance of stability within a region or HN. CMI is essential to effective partnerships between U.S. forces, HNs and partner nations, unified action partners, multinational forces, NGOs, international organizations, the interagency, and the private sector. CMI enables unified action and supports unity of effort based on the commander's mission goals.

SHAPE

3-8. Shaping the OE helps set the conditions for successful theater operations. Shaping operations are designed to dissuade or deter adversaries, assure friends, and set conditions for contingency plans. CA forces support the shaping activities of the commander through conducting CAO, enabling unified action, and providing an added stabilizing effect on the OE. Shaping activities precede operation order activation and continue through and after an operation order is terminated, with the intent of enhancing international legitimacy and gaining multinational cooperation. CAO, through its support of the elements of decisive action, enable—

- Building civil networks through CNDE.
- Conducting preparation of the environment.
- Providing U.S. forces with peacetime and contingency access.
- Mitigating conditions that could lead to a crisis.
- Setting the conditions for stability through TG.
- Setting the conditions for civil security through TG, CMI, and CNDE.
- Increasing governance capacity and capability through SCA.

- Improving information exchange and intelligence sharing through the collaborative fusion of civil and threat information through CKI and CMI.
- Developing allies and friendly military capabilities for self-defense and multinational operations in conjunction with inter-organizational partners.
- Shaping perceptions and influencing the behavior of adversaries and allies.
- Increasing situational understanding of the civil component for the commander in exercise of command and control.

PREVENT

3-9. Prevent operations include all activities to deter an adversary's undesirable actions and cease deterioration of a situation in a manner that is contrary to U.S. interests. These activities are an extension of shaping operations. These activities are designed to prevent adversary opportunities to further exploit positions of relative advantage by raising the potential costs, to adversaries, of continuing activities that threaten U.S. interests.

3-10. Prevent activities enable the joint force to gain positions of relative advantage prior to potential combat operations. Prevent activities are weighted toward actions to protect friendly forces, assets, and partners, and to indicate U.S. intent to execute subsequent phases of a planned operation.

3-11. During operations to prevent, CA forces provide or enable stability and prevention of future conflict by supporting Army forces in the performance of the following activities:

- Developing and executing flexible deterrent options and flexible response options.
- Enabling the Army to conduct reception, staging, onward movement, and integration; tailor forces; and project power through CNDE and CMI.
- Increasing information collection through CNDE and CKI to provide detection, focus relevant collection on named areas of interest, and recognize early warnings and threat indicators to the civil component.
- Building friendly civil networks, influencing neutral civil networks, and degrading threat networks in the civil component.
- Integrating friendly civil networks into operations to—
 - Increase governance capacity and capability through TG.
 - Disrupt threats in the civil component.
 - Increase freedom of action for U.S. forces.
 - Create multiple dilemmas to obstruct and disrupt threat actors.

LARGE-SCALE COMBAT OPERATIONS

3-12. The execution of large-scale combat operations involves the combination of offense, defense, and stability operations tasks. Army forces defeat enemy organizations, control terrain, protect populations, and preserve joint force and unified action partner freedom of movement as part of the joint team. During large-scale combat operations, it is imperative to plan for civil considerations because they are a key piece of every operation. CA forces conduct CAO in support of decisive action to enable the following components of large-scale combat operations:

- Situational understanding through CKI to—
 - Effect enhanced decision making of the commander.
 - Enable command and control.
 - Inform warfighting functions.
- Stability within the civil component, through TG, focused through the five USG stability sectors.
- Targeting.
- Reduction of civil interference through TG, CNDE, and CMI.
- Enablement of freedom of maneuver through TG, CNDE, and CMI.

- Preservation of combat power.
- Creation of multiple dilemmas.

CONSOLIDATE GAINS

3-13. CA forces secure the victory by consolidating gains. Army operations to consolidate gains include activities to convert any temporary operational success into an enduring success and to set the conditions for a sustainable security environment—allowing for a transition of control to other legitimate authorities. Consolidation of gains is an integral and continuous part of armed conflict, and it is necessary for achieving success across the competition continuum. Army forces deliberately plan to consolidate gains during all phases of an operation. Early and effective consolidation activities are a form of exploitation conducted while other operations are ongoing, and they enable the achievement of lasting favorable outcomes in the shortest time span. CA forces enable consolidation of gains through developing and leveraging of civil networks. These networks have capabilities and resources that can be used to reestablish a sustainable security environment that will allow commanders to use fewer military resources.

3-14. Army forces consolidate gains by executing area security and stability operations tasks (focused through the five USG stability sectors) when the operational emphasis in an AO shifts from large-scale combat operations. Consolidating gains enables a transition from the occupation of a territory and control of populations by Army forces—that occurred as a result of military operations—to the transfer of control to civil authorities. Activities to consolidate gains continue through all phases of a military operation.

3-15. CA forces must evaluate the capability and capacity of the HN to provide services. These forces must also determine the ability of other USG agencies, international agencies, NGOs, and contractors to provide support. CA forces, as required, will lead and direct these identified capabilities and capacities until the proper civilian control is enacted. The goal is to address sources of conflict or friction, foster resilience of the HN, and create conditions that enable sustainable peace and security. CA forces conduct CAO in support of the elements of decisive action to—

- Conduct SCA and transitional military authority during transitions across the competition continuum.
- Enable situational understanding through CNDE and CKI.
- Establish security, create stability, and reduce civil interference through CNDE, CMI, and PRC.
- Provide essential services (such as restoration or development) through TG.
- Prevent future conflict.
- Enable area security through CNDE by the identification of civil network resources, capabilities, and capacities that can be utilized.
- Support stability operations tasks.
- Influence local and regional audiences.
- Plan and execute measures to transition from area security to civil security.

Note: FM 3-0 provides additional information on the strategic roles of the Army in support of joint operations.

TRANSITION OPERATIONS

3-16. Post-conflict stability activities begin with significant military involvement then, move increasingly toward civilian dominance—with the diminishment of the threat and the reestablishment of civil security and civil control. Termination or transition occurs when U.S. forces accomplish their mission, or the President or SecDef directs that the mission be completed. Transitions at the conclusion of any major military operation require significant preparation, planning, and coordination among the partner nation government, HN, interagency community, NGOs, and international organizations. During transition, U.S. military forces will support long-term U.S. interests and strategic objectives, including the establishment of security and stability in the region.

3-17. Commanders must initiate transition planning prior to, or during, the initial phases of operation planning to ensure they give adequate attention to this critical area. Leaders may base the criteria for termination or transition on events, measures of effectiveness and success, availability of resources, or a specific date. Transitions may occur independently, sequentially, or simultaneously across the AO or within a theater. Ideally, U.S. forces execute each type of transition according to synchronized transition plans. Depending on the situation, CAO in transition operations may be—

- Terminated.
- Transferred to follow-on forces.
- Transitioned to other government agencies, IPI, or international organizations.

3-18. CA forces play a critical role in TG planning. Based upon their expertise and understanding of governance, stability operations tasks, and the USG stability sectors, these planners are the best individuals to perform this function. Planners must have a clearly identifiable end state and transition of authority, or termination criteria for the operation to accomplish the task of transition planning. The transition plan prioritizes and plans for the successful handover of missions to interorganizational partners or a follow-on military force.

3-19. CA forces play a critical role in both planning and executing the transition process. In any major operation or lesser contingency, CA forces have significant interaction with the civilian populace and the local government. CA personnel must ensure that the gains made in the AO are not lost in the transition process. Civil Affairs teams (CATs) are also expected to prepare a transition plan that includes all ongoing projects, coordination points of contact, resources, and other information for incoming forces or appropriate civil authorities.

3-20. CA forces are heavily involved in the transition process. During transition, CA forces prepare to hand over their role as the facilitator between U.S. forces and international organizations, NGOs, other interagency organizations, and local government agencies. CA personnel prepare a transition plan that includes all ongoing projects and coordination points of contact for all agencies, possible resources, and any other information that may facilitate the transition process. CA forces support joint, combined, or single-Service operations from the strategic to the tactical level.

DECISIVE ACTION

3-21. As depicted in figure 3-1, page 3-6, CAO are conducted within the four elements of decisive action, which are offense, defense, stability, and DSCA. CA forces support unified land operations through all phases at the strategic, operational, and tactical levels of warfare. Commanders at all levels must plan to integrate civil considerations during operations. Within the OE, U.S. commanders could and can have access to indigenous supplies, facilities, services, and labor resources that may be used to support military operations. Combat operations can be disrupted by uncontrolled and uncoordinated movement of civilians and hostile or illegal actions by entities within the populace. Leveraging, integrating, and coordinating of IPI and local civil networks with military operations enhances the ability of the commander to achieve a desired end state.

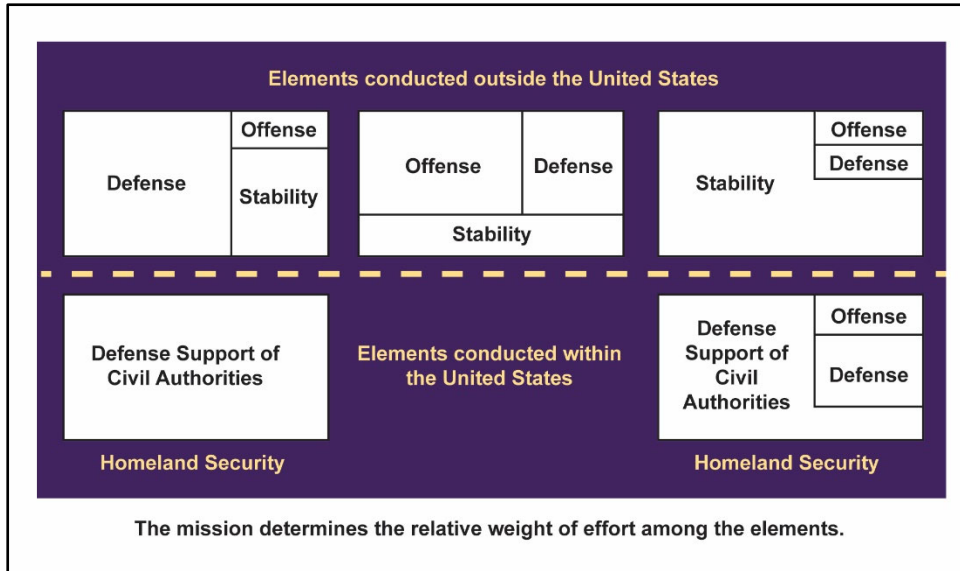


Figure 3-1. Decisive action

OFFENSE

3-22. An *offensive operation* is an operation to defeat and destroy enemy forces and gain control of terrain, resources, and population centers (ADP 3-0). Offensive operations impose the will of the commander on the enemy. The offense is the most direct means of seizing, retaining, and exploiting the initiative to gain a physical and psychological advantage. In the offense, the decisive operation is a sudden action directed toward enemy weaknesses, which capitalizes on speed, surprise, and shock. If that operation fails to destroy the enemy, operations continue until enemy forces are defeated. Executing offensive operations compels the enemy to react, which creates new or larger weaknesses the attacking force can then exploit.

Note: ADP 3-90 provides a detailed outline of offensive operations.

3-23. During offensive operations, the primary focus is defeat or destroy enemy forces and gain control of terrain. During these operations, CA forces must also plan for civil considerations and threats within the civil component. The full capability of the CA force is essential to and manifests in the conduct of successful offensive operations at the strategic, operational, and tactical levels. CAO support to offense includes the execution of all four CA core competencies and continuous analysis of the civil component—in terms of both operational and mission variables—by CAO staff elements. Critical tasks executed by CA forces in support to offense include—

- Providing employment options for CA capabilities.
- Gaining civil information and developing civil networks through CND, CR and CE.
- Collecting civil information to—
 - Develop and maintain the civil component of the common operational picture of the commander.
 - Enhance and enable freedom of movement and maneuver.
 - Enhance and enable preservation of combat power.
 - Enable the isolation of enemy forces.
 - Enable the legitimacy of the U.S. mission.
- Providing civil component analysis and evaluation toward the identification of—
 - Irregular threats.
 - Centers of gravity.
 - Decisive points.

- Critical links and nodes of civil networks.
 - Branches and sequels.
- Denying civil component resources to the enemy through CNDE.
- Leveraging established civil network capabilities and resources to create multiple dilemmas for an enemy, thereby reducing the ability of the enemy to allocate resources and forces to the fight.
- Nominating restrictive-fire areas and no-fire areas to minimize damage to the civil infrastructure and culturally sensitive sites.
- Producing effects in the civil component of the OE.
- Integrating with operations to secure critical civil assets, thereby freeing U.S. forces for other tasks.
- Tracking damage to infrastructure and other combat-related effects to the civil component.
- Providing civil component analysis to planning processes.
- Integrating civil knowledge to develop the common operational picture.
- Planning and conducting PRC operations to increase the burden to adversaries and threats (by creating strategic and political dilemmas).
- Advising on the presence of culturally, economically, and politically significant assets and resources within the AO.
- Developing courses of action that will lead to area security and civil control by integrating stability operations tasks.
- Preventing or mitigating civilian interference with military operations and the impact of military operations on the civil populace.
- Identifying, preventing, and addressing friction points between military forces and the civil population.

DEFENSE

3-24. A *defensive operation* is an operation to defeat an enemy attack, gain time, economize forces, and develop conditions favorable for offensive or stability operations (ADP 3-0). Normally the defense cannot achieve a decisive victory. However, it sets conditions for a counteroffensive or a counterattack that enables forces to regain the initiative. Defensive operations are a counter to an enemy offensive action. They defeat attacks, thereby destroying as much of the attacking enemy as possible. They also preserve control over land, resources, and populations. The purpose of defensive operations is to retain key terrain, guard populations, protect lines of communications, and protect critical capabilities against enemy attacks. Commanders execute defensive operations to gain time, promote civil security, and economize forces so offensive operations can be executed elsewhere.

Note: ADP 3-90 provides a detailed outline of defensive operations.

3-25. The full capability of the CA force is essential to and manifests in the conduct of successful defensive operations at the strategic, operational, and tactical levels. CAO support to defense includes the execution of all four CA core competencies and continuous analysis of the civil component—in terms of both operational and mission variables—by CAO staff elements. Critical tasks executed by CA forces supporting defense include—

- Recommending employment options for CA capabilities.
- Collecting civil information through CNDE to—
 - Develop the civil component of the common operational picture for the supported commander.
 - Isolate enemy forces.
 - Fill intelligence, surveillance, and reconnaissance gaps through CND, CR, and CE.
- Providing civil component analysis and evaluation through CNDE and CKI toward the identification of—
 - Centers of gravity.
 - Decisive points.

- Critical links and nodes.
- Branches and sequels.
- Developing and engaging civil networks to provide civil security and civil control.
- Denying the enemy civil component resources through CNDE.
- Creating multiple dilemmas for an enemy thereby reducing the ability of the enemy to allocate resources and forces to the fight.
- Nominating restrictive-fire areas and no-fire areas to minimize damage to the civil infrastructure and culturally sensitive sites.
- Tracking damage to infrastructure and other combat-related effects to the civil component.
- Providing options to the commander to produce effects in the civil component of the OE.
- Providing civil component analysis to planning processes to protect the populace, critical assets, infrastructure, and resources.
- Integrating civil networks to secure critical civil assets, thereby freeing U.S. forces for defensive tasks.
- Planning and conducting PRC options to increase the burden to adversaries and threats (by creating strategic and political dilemmas).
- Advising on the presence of culturally, economically, and politically significant assets and resources within the AO.
- Advising on counter mobility operations directed at economically significant roads, railways, bridges, and other infrastructure.
- Advising the commander on civilian movements during the planning for emplacement of obstacles, such as minefields.
- Developing courses of action that will lead to area security and civil control by integrating stability operations tasks.
- Preventing or mitigating civilian interference with military operations and the impact of military operations on the civil populace.
- Identifying and leveraging civil network capabilities, capacities, and resources to enhance the commander's mission and reduce the use of military resources.
- Identifying and addressing friction points between military operations and the civil population.

STABILITY

3-26. A *stability operation* is an operation conducted outside the United States in coordination with other instruments of national power to establish or maintain a secure environment and provide essential governmental services, emergency infrastructure reconstruction, and humanitarian relief (ADP 3-0). According to ADP 3-0, "Commanders are legally required to provide minimum-essential stability operations tasks when controlling populated areas of operations. These essential services provide minimal levels of security, food, water, shelter, and medical treatment."

3-27. CAO are inherently stabilizing in the context of U.S. interests and consolidation of gains. Stability operations—

- Support governance by an HN, an interim government, or a military government.
- Involve coercive and constructive actions.
- Help to establish and maintain a safe and secure environment and facilitate reconciliation among local or regional adversaries.
- Assist in building relationships among unified action partners.
- Promote U.S. security interests.
- Help establish and improve political, legal, social, and economic institutions while supporting transition to a legitimate host-nation government.
- Cannot succeed if they only react to enemy initiatives.
- Must maintain the initiative by pursuing objectives that resolve causes of instability.

Note: JP 3-07, ADP 3-07, and FM 3-07 provide additional information on stability.

3-28. CA forces set the conditions for stability operations by conducting CAO during the execution of offensive and defensive tasks to preserve combat power and lethality by mitigating the effects of the civil component on combat operations. The level of CAO support required to execute stability operations is directly related to the conditions within the OE. The CAO staff continually monitors the condition of the HN throughout the operation, applies available resources to affect the civilian component, and recommends military government or functional skills required to support this critical phase. CAO support conventional forces, SOF, USG agencies, and the host-nation civil administration in transitioning power back to a local government.

3-29. CAO provide the commander with the ability to execute the stability mechanisms of compel, control, influence, and support in order to establish a lasting and stable peace. TG, CNDE, and CMI, specifically provide the commander the capability to interface with the civil component. CNDE actions enable the commander to compel in order to effect behavioral change. TG and CNDE actions provide the commander the ability to control in an effort to establish civil order and safety. CNDE and CMI provide options to influence in an effort to alter opinions of friendly, neutral, unknown, and threat populations. The implementation of all CA core competencies provides support to the civil population in order to set conditions necessary for the instruments of the host-nation government to function effectively.

3-30. Integration with civil networks in the AO also enables a commander to fully employ the defeat mechanisms of dislocate, disintegrate, and isolate. Civil networks provide advanced indicators and warnings of enemy presence through civil knowledge (which is integrated within CPB to inform IPB of a command) and targeting processes to allow for more accurate and effective planning.

3-31. The full capability of the CA force is essential to, and manifests in, the conduct of successful stability operations at the strategic, operational, and tactical levels. CAO support to stability includes the execution of all four CA core competencies and continuous analysis of the civil component—in terms of both operational and mission variables—by CAO staff elements. Critical tasks executed by CA forces supporting stability include—

- Recommending employment options for CA capabilities.
- Collecting civil information through CND, CR and CE.
- Integrating civil knowledge to develop the common operational picture.
- Providing civil component analysis and evaluation toward the identification of—
 - Centers of gravity.
 - Decisive points.
 - Critical links and nodes of civil networks.
 - Branches and sequels.
- Providing government function specialists to enable SCA and transitional military authority missions.
- Providing government function specialist support as required.
- Strengthening governance and participation through CMI and CNDE.
- Safeguarding civil component resources and capabilities.
- Planning and directing PRC, in coordination with the provost marshal and military police that support transitional public security to promote, restore, and maintain public order, and protect civilian populations when civil security has broken down or is nonexistent.
- Developing mitigation strategies to minimize unnecessary damage to the civil infrastructure and culturally sensitive sites.
- Identifying and tracking damage to civil infrastructure, personal property, and culturally sensitive sites.
- Integrating civil knowledge into the planning processes to protect the populace, critical assets, and infrastructure.
- Planning and executing DC operations to address endangered populations.

- Advising on the presence of culturally, economically, and politically significant assets and resources within the AO.
- Fostering economic stability and development.
- Assessing the activities and capabilities of the IPI, unified action partners, and interagency in relation to achieving national policy goals and shaping the environment for interagency and host-nation success.
- Conducting budgetary programming and management in order to resource stability projects and programs in support of stability objectives.
- Providing liaisons to the interagency, IPI, and unified action partners, as necessary.
- Identifying and assessing the measures of performance and measures of effectiveness of CAO.
- Through CMI, facilitating the integration, coordination, and synchronization of civilian agencies and organizations with military forces.
- Providing civil component analysis and evaluation to identify root causes of instability.
- Providing CAO support to the disarming, demobilizing, and reintegration of former belligerents into civil society, and providing a secure environment.
- Providing CAO support to rehabilitating former belligerents and units into legitimate security forces.

3-32. Figure 3-2 depicts CA support to a corps offensive.

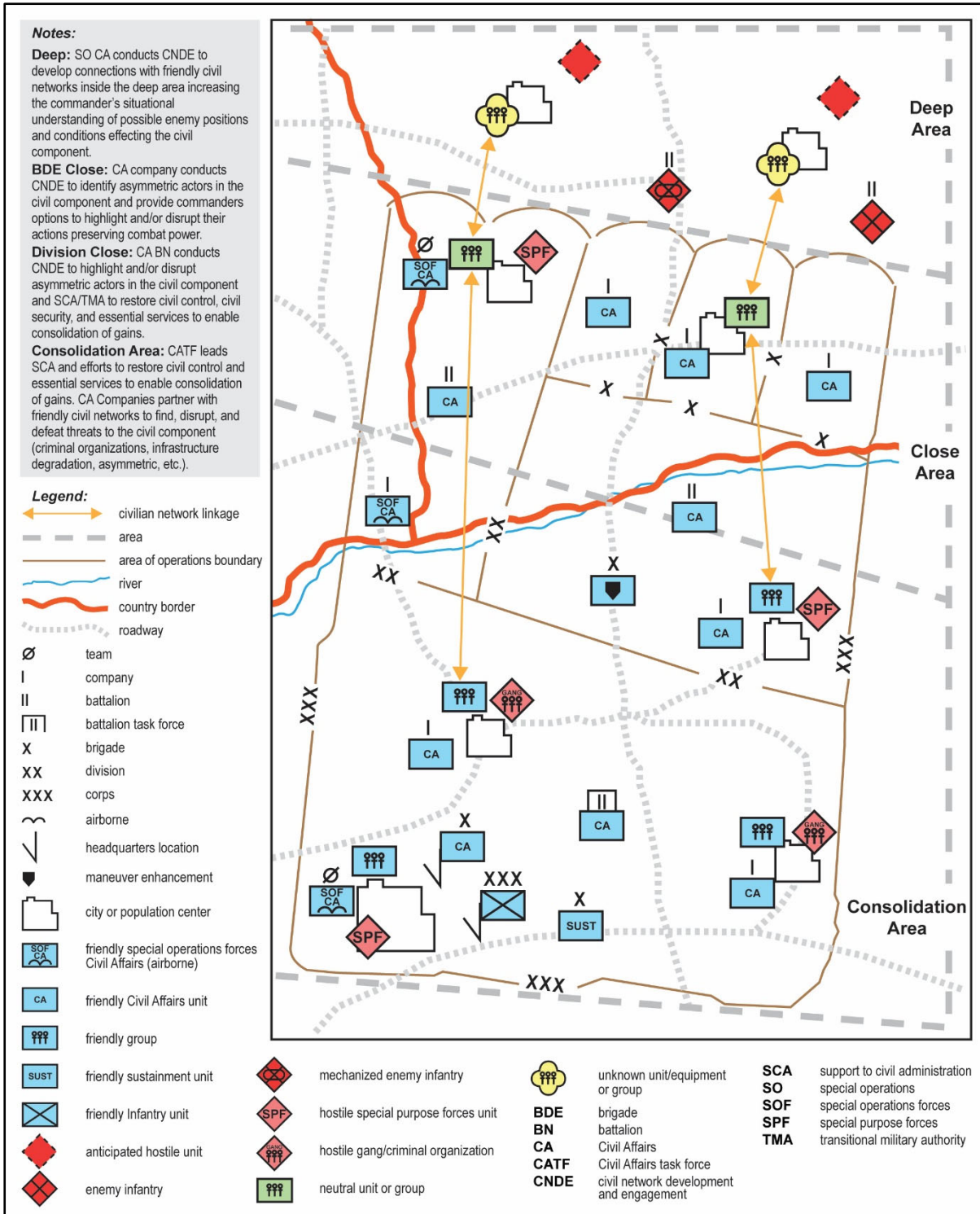


Figure 3-2. Civil Affairs support to a corps offensive

DEFENSE SUPPORT OF CIVIL AUTHORITIES

3-33. According to DODD 3025.18, DSCA is support provided by U.S. federal military forces, DOD civilians, DOD contract personnel, DOD component assets, and National Guard forces (when the SecDef, in coordination with the governors of the affected states, elects and requests to use those forces in 32 USC status) in response

to requests for assistance from civil authorities for domestic emergencies, law enforcement support, and other domestic activities, or from qualifying entities for special events. DSCA is a task executed in the homeland and in U.S. territories. DSCA is conducted in support of another primary agency, lead federal agency, or local authority. National Guard forces are usually the first forces to respond on behalf of state authorities. When federal military forces are employed for DSCA activities, they remain under federal military command and control at all times.

3-34. It is DOD policy that the DOD will cooperate with and provide DSCA as directed by and consistent with applicable law, presidential directives, executive orders, and DODD 3025.18. Defense assistance is in support of civilian authorities who retain primary responsibility. DODD 2000.13 states “DOD Civil Affairs capabilities may be used to assist in domestic emergencies and to provide other support to domestic civil authorities consistent with law and in accordance with DODD 3025.18, DODI 3025.21, other DOD issuances, and supporting plans.”

3-35. United States Northern Command and United States Pacific Command are the combatant commands with standing missions to conduct DSCA providing, as directed by the President or the SecDef, military assistance to civil authorities including crisis management and consequence management (domestic incident management). In addition, USSOCOM has responsibilities for countering weapons of mass destruction and civil disturbance operations in accordance with DODD 2060.02 and DODI 3025.21. Generally, CA tasks include—

- Providing consultation to decision makers through the defense coordinating officer.
- Participating in interagency assessment, planning, and synchronizing of DSCA tasks through the joint task force (JTF) and the defense coordinating officer.
- Executing CAO in support of selected DSCA tasks, as needed or directed.

3-36. CA government function specialists may participate in DSCA based on METT-TC analysis.

Note: DODD 3025.18, JP 3-28, and ADP 3-28 provide additional information on the role of U.S. forces in DSCA. DODI 3025.21, DODI 5400.11, and DODD 5200.27 provide information regarding the legalities of the collection of data during DSCA.

POPULACE AND RESOURCES CONTROL

3-37. All military operations are conducted in environments where a civilian presence or influence might impact the mission. Military operations can be disrupted by actions of the IPI, non-state actors, and entities inside and outside of the AO. Whether controlled, uncontrolled, or uncoordinated, these civilian movements can adversely affect the battlefield. Civilian movement within the OE (such as illegal activities, protests, displaced civilians, or any other civil functions) can impact the mission of the commander. Commanders must consider PRC measures in the planning and execution of operations. These measures must always be coordinated with local civil leadership and conducted in support of civil administration.

3-38. PRC is a primary requirement of the military police, and CA forces are integral to the planning, execution, and assessment of military operations concerning PRC measures. Properly conducted, PRC is an extension of the functioning local civil administration and is more effective when led and executed locally.

3-39. CA forces are highly attuned to the impacts that military operations may have on the civil population, and impacts the civil component will have on military operations. They assist in the development of courses of action that will support the goals of the commander while having minimum impact on civil-military relations and current and future operations. Civil networks developed during the CNDE process are integrated into operations to aid in the planning and execution of PRC actions. Utilizing these networks builds legitimacy with local populations. It also provides for the preservation of combat power of commanders during large-scale combat operations and requires fewer military resources during competition and return to competition.

3-40. PRC consists of two distinct, yet linked, components—populace control and resources control. Both components are normally the responsibility of indigenous civil governments. During times of civil or military emergency, proper authorities define, enact, and enforce PRC measures. For practical and security reasons, military forces employ PRC measures of some type and to varying degrees across the competition

continuum. PRC operations are executed with, and as an integral part of, military operations. CA forces provide multiple capabilities to the commander assisting in the development and execution of these measures. Every CA unit has the ability to access government function specialties capabilities within the CACOM to facilitate the identification, requisition, and utilization of the full range of CA government function specialist capabilities, as required, in support of PRC efforts.

POPULACE CONTROL

3-41. Populace control measures are a key element in the execution of primary stability operations in the areas of civil security and civil control. Populace control involves—

- Establishing public order and safety.
- Securing borders, population centers, and individuals.

3-42. International law requires the military force to focus on essential tasks that establish a safe, secure environment and address the immediate humanitarian needs of the local populace, resources, and capabilities. CA forces are critical in the planning, development, and assessment of these control measures to ensure commanders are provided with the effects that meet mission requirements. Control measures require a capability to—

- Secure borders.
- Protect the population.
- Hold individuals accountable for criminal activities.
- Control the activities of individuals or groups that pose a security risk.
- Reestablish essential civil services.
- Set conditions in the OE that support stability through unity of effort.

3-43. The authority and extent of populace control measures that a commander may impose varies greatly with the type of mission and the OE. The OE includes a wide variety of intangible factors, such as the culture, perceptions, beliefs, and values of adversary, enemy, neutral, or friendly political and social systems. These factors must be analyzed and continuously assessed throughout the operations process to develop a situational understanding of the environment. The characterization of the OE as permissive, uncertain, or hostile further impacts the planning for and the execution of populace control measures.

3-44. Populace control provides security for the populace, mobilizes human resources, denies enemy access to the population, and detects and reduces the effectiveness of enemy agents. Populace control measures may include the following:

- Establishing border security, including immigration procedures to—
 - Prevent trafficking of persons.
 - Regulate immigration and emigration.
 - Establish control over major points of entry.
- Establishing identification procedures, including securing documents relating to—
 - Personal identification.
 - Property ownership.
 - Court records.
 - Voter registries.
 - Birth certificates.
 - Driver's licenses.

- Establishing and disseminating rules relevant to movement, including—
 - Curfews.
 - Movement restrictions.
 - Travel permits.
- Instituting policies regarding the regulation of air and overland movement.
- Relocating the population as necessitated by military operations.
- Establishing transitional political authority and interim civil administration.

3-45. CA forces provide the commander and staff the capability to plan, synchronize, and assist in the execution of populace control through mobilization of developed civil networks and SCA. Once the populace control measures are in place, CA forces assess these measures, provide feedback to the commander on the effectiveness of the measures, and provide recommendations on adjustment to the measures as necessary.

3-46. DC operations are a special category of populace control that requires extensive planning and coordination among various military and nonmilitary organizations. DC operations are actions required to move or keep civilians out of harm's way or to safeguard them in the aftermath of a disaster. The disaster may be natural (such as a flood or an earthquake), human-made (such as combat operations, social, or political strife), or a technological (such as radiological disaster, network outage, intrusion, cyberspace attack, or a complete loss of electricity).

3-47. The requirement to conduct DC operations may occur during any phase across the competition continuum. The execution of CNDE is critical to identifying and developing civil network capabilities, capacity, and resources that can be used to provide for the needs of DCs. If DCs are within their nations' borders, USAID may be involved in providing assistance, whereas a refugee falls under the assistance of the Bureau of Population, Refugees, and Migration of the DOS.

3-48. The supporting tasks conducted by CA forces in DC operations support the freedom of movement of the friendly forces while safeguarding the civilian population. These tasks include—

- Identifying or evaluating existing host-nation and international community DC plans and operations.
- Advising on DC control measures that would effectively support the military operation.
- Advising on how to implement DC control measures.
- Publicizing control measures among the IPI.
- Assessing measures of effectiveness.
- Participating in the execution of selected DC operations as needed or directed and in coordination with the internationally mandated organizations (such as United Nations High Commissioner for Refugees, Office for the Coordination of Humanitarian Affairs, and the International Committee of the Red Cross).
- Assisting in arbitration of problems arising from implementation of DC control measures and deconflicting with host-nation plans.
- Identifying DC locations and composition.
- Coordinating with the sustainment warfighting function to deconflict humanitarian assistance in the unit's area of responsibility.
- Collect information regarding possible threat locations, composition, and pending attacks.
- Collect civil information regarding civil conditions of the locations from which the DCs travelled.
- Develop civil networks to leverage capabilities, capacities, and resources within the AO to support DCs.

3-49. The term DC is unique to the DOD and not used by the DOS and NGOs. These organizations use the term internally displaced persons for civilians displaced within their country and the term refugees for people who flee their country of origin and cross an international border. The following distinctions exist among the various categories of DCs:

- According to JP 3-29, displaced persons is a broad term used to refer to internally and externally displaced persons collectively. In addition—
 - Returnees are displaced persons who have returned voluntarily to their former place of residence.
 - Resettled persons are a subset of displaced persons. These are civilians who have been able to resettle in a third country, usually with the assistance of United Nations High Commissioner for Refugees and the government of their new country of residence, rather than returning to their previous home or land within the country or area of original displacement. Resettled persons are usually a very small subset of the original displaced population as opportunities for third country resettlement are rare.
- Evacuees are civilians who are removed from their places of residence by military direction for reasons of personal security or the requirements of the military situation.

Note: The term evacuee is unique to the DOD and not used by the DOS (except for noncombatant evacuation operations), NGOs, or international organizations.

- Internally displaced persons are any persons who have been forced or obliged to flee or to leave their home or place of habitual residence, in particular as a result of, or in order to avoid the effects of armed conflict, situations of generalized violence, violations of human rights or natural or human-made disasters, and who have not crossed an internationally recognized state border.
- Migrants are persons who belong to a normally migratory culture who may cross national boundaries or have fled their native country for economic reasons rather than fear of political or ethnic persecution. Migrants travel to escape economic stagnation and poverty. This is in contrast to refugees, who travel to escape persecution, conflict, and perhaps death.
- Refugees are any persons who, owing to a well-founded fear of being persecuted for reasons of race, religion, nationality, membership of a particular social group or political opinion, are outside the country of their nationality and are unable or, owing to such fear, are unwilling to avail themselves of the protection of that country.
- Stateless persons are civilians who either have been denationalized, whose country of origin cannot be determined, or who cannot establish their right to the nationality claimed.

3-50. While the following are not categories of DCs, they are categories of civilians with whom military members may come into contact in an operational area and should be part of this discussion for FHA:

- **Trafficking Victims.** Simply stated, trafficking in persons is modern-day slavery, involving victims who are forced, defrauded, or coerced into labor or sexual exploitation, such as recruitment, harboring, transportation, provision of, or obtaining of a person for the purpose of a commercial sex act, in which any of these apply:
 - A commercial sex act is induced by force, fraud, or coercion.
 - The person induced to perform such an act has not attained 18 years of age.
 - The recruitment, harboring, transportation, provision of, or obtaining of a person for labor or services through the use of force, fraud, or coercion is for the purpose of subjection to involuntary servitude, peonage, debt bondage, or slavery.
- **Vulnerable Persons.** Vulnerable persons are persons who may not have equal access to humanitarian assistance because of physical, cultural, or social barriers (examples include, women, children, the elderly, the disabled, ethnic minorities, and people living with an incurable virus or disease). While this is not a legal distinction, it is important to describe this population, as it is the most vulnerable who often have the greatest needs.

Note: JP 3-29 provides additional information on DCs.

3-51. In DC operations, controlling agencies (such as United Nations High Commissioner for Refugees, Office for the Coordination of Humanitarian Affairs, International Committee of the Red Cross, or the HN) normally care for the basic needs of DCs. This usually means they provide food, water, shelter, sanitation, and security. Controlling agencies must also be prepared to prevent or arrest the outbreak of communicable disease among DCs. This last point is important for the health of the populace and military forces.

Note: FM 3-39, ATP 3-39.30, and ATP 3-57.10 provide additional information on DC operations.

3-52. During military operations, U.S. forces must consider two distinct categories of civilians—

- Those remaining at their homes or places of habitual residence.
- Those dislocating.

3-53. U.S. policy dictates the placement of people in one of these categories. The U.S. category may conflict with how international organizations, NGOs, and the HN refer to the people. Therefore, CA forces executing CNDE must ensure that the description of each category of civilian is accurate and used the same throughout the process. These categories become critical as CA forces develop civil networks to support DCs and execute TG to consolidate gains, enable area security, and increase civil security.

3-54. The first category includes civilians who are indigenous and other local populace, including civilians from other countries. Civilians within this category may need help. If they are able to care for themselves, they should remain in place.

3-55. On the other hand, DCs are civilians who have left their homes. Their movement and presence hinder military operations. They will likely require some degree of aid, such as medicine, food, shelter, clothing, and similar items. These needs will be identified through the execution of CNDE, and the civil networks that are developed can be leveraged to assist with appropriate resources to support DCs. DCs may not be indigenous to the area or to the country in which they reside.

RESOURCES CONTROL

3-56. Resources control provides security for the natural and human-made materiel resources of a nation-state, mobilizes economic resources, denies enemy access to resources, and detects and reduces the effectiveness of enemy agents and criminal entities. Resources control measures include, but are not limited to—

- Licensing.
- Regulations or guidelines.
- Checkpoints.
- Border security, to include—
 - Customs inspections.
 - Ration controls.
 - Amnesty programs.
 - Inspection of facilities.

3-57. Resources control directly impacts the economic system of an HN or territory occupied and governed by U.S. forces. Resources control measures regulate public and private property and the production, movement, or consumption of materiel resources. Controlling a nation's resources is the responsibility of indigenous civil governments. During a civil or military emergency, proper authorities define, enact, and enforce resources control measures to maintain public order and enable the execution of primary stability operations in the areas of civil security, civil control, restoration of essential services, and support to economic and infrastructure development tasks.

3-58. Enactment of resources control measures must conform to legal and regulatory policy and be enforced justly and firmly by the governing authority. U.S. forces will not execute these measures unless the requirements are clearly beyond the capabilities of the security forces of the HN, the HN has requested assistance, and appropriate U.S. authorities (to include the U.S. Ambassador) have granted approval for such assistance.

3-59. Resources control includes property control which is the control of movable and immovable private and public property. CA generalists support the lead of the HN by facilitating integration and security while CA military government and government function specialists support by providing advice, assistance, and training for host-nation forces executing these missions. Resource control measures may include—

- Establishing procedures to resolve property rights for land and subterranean resources.
- Implementing mechanisms to prevent unauthorized seizures of land or property.
- Securing existing harvest storage facilities to prevent spoilage and looting of harvested crops.
- Implementing rationing and distribution programs for key commodities (such as food and fuel).
- Establishing border security, including customs procedures to prevent arms smuggling and stop contraband (such as drugs and natural resources).
- Regulating and securing access to valuable natural resources.
- Stopping illicit trade in natural resources and developing governance mechanisms and incentives to bring trade into the market.
- Initiating processes for addressing and resolving resource ownership and access issues.
- Freezing financial accounts of enemy combatants.
- Locking international access of overseas financial accounts to prevent money laundering.
- Protecting and securing strategically important institutions, such as government buildings and archives, museums, religious sites, courthouses, and communications facilities.

3-60. Implementing effective resources control requires the host-nation government or transitional military authority to inform the populace of the measures to be imposed and the justification for the action. The message to the population must clearly convey that the control measures are necessary to ensure the security of the populace. Enforcement of the restrictions must be consistent and impartial so that the government establishes and maintains legitimacy among the populace. A well-crafted PRC plan limits control measures to the least restrictive measures necessary to achieve the desired effect. Continuous assessment of the OE measures the effectiveness of the restrictions, the attitude of the population toward the government, and the impact the restrictions have on the OE. As the security situation improves, restrictions should be modified or rescinded.

HOMELAND DEFENSE

3-61. *Homeland defense* is the protection of United States sovereignty, territory, domestic population, and critical infrastructure against external threats and aggression or other threats as directed by the President (JP 3-27). The DOD has lead responsibility for homeland defense. The strategy for homeland defense (and DSCA) calls for defending the U.S. territory against attack by state and non-state actors through an active, layered defense that aims to deter and defeat aggression abroad and simultaneously protects the homeland. The Army supports this strategy with capabilities in forward regions of the world, geographic approaches to U.S. territory, and within the U.S. homeland.

3-62. CA forces conduct CAO in support of homeland defense if directed by government authorities. CA forces possess unique capabilities to assist in the stabilization of civil infrastructure and functions. This includes the establishment of a CMOG for integration, coordination and synchronization of resources, personnel, and efforts by multiple entities that are working toward stabilizing the impacted areas. The capabilities provided by CNDE, CR, CE, and SCA, along with the processing of civil information through CKI enables the transition of operations back to the proper civilian authorities more quickly.

THE EXTENDED BATTLEFIELD

3-63. CA forces interact with the civil component of the OE. This increasingly places their interactions in dense urban environments, cyberspace, and the information environment. CA forces must understand the environments that are frequented by civilians and how to enable commanders to monitor and produce effects in those environments.

DENSE URBAN ENVIRONMENT

3-64. With the increasing urbanization of modern society conflicts will inherently take place in dense urban environments. These environments present a number of challenges that the Army must prepare for and address if it will be successful in future missions. Major cities grow together forming regions of dense populations that stretch hundreds of kilometers and can encompass over 100 million people. These dense urban environments are extremely complex in the following ways, which make them difficult to control:

- Modern cities are multidimensional (subterranean, surface, and vertical).
- Cities are interconnected through globalization, social media, and modern methods of communication/information dissemination.

3-65. Through the execution of TG, CNDE, CKI, and CMI, CA forces provide critical civil knowledge to, and expand options for, the supported commander. This increases situational understanding of the OE and allows clarity for visualization of the battlefield and actionable civil knowledge for the decision-making process. During the fast pace of offensive operations commanders may bypass large population centers. When passing by or through large population centers civilians and military elements may come into conflict and slow the advance. CA forces develop networks and support governance in these population centers as a way to enable host-nation elements to maintain control.

3-66. By developing these civil networks, CA forces can identify civil capabilities, capacities, and resources that can support consolidation of gains, provide area security, and enable civil security within these population centers. CA forces can conduct TG to ensure that government functions continue until those functions can be turned over to proper civilian authorities.

3-67. Using these methods, CA forces can use combat power elsewhere on the battlefield to defeat the enemy when CA forces enable a commander to—

- Preserve combat power.
- Extend command and control into areas that are normally not within the control of the commander.
- Control influence (through CA units of action and their associated civil networks).
- Increase the maneuverability of forces.

3-68. In defense and stability operations, CA forces develop and mobilize networks that deny space to threat networks and simultaneously provide governance to address the hardships placed on the population due to the destruction caused by large-scale combat operations. These networks allow for an effective transition of the OE to host-nation control. These networks also reduce the amount of military resources necessary to consolidate gains. These efficiencies enable commanders to focus military resources and capabilities in areas where civil networks are not as robust or in locations where there is a lack of essential civil capabilities and resources.

CYBERSPACE

3-69. *Cyberspace* is a global domain within the information environment consisting of interdependent networks of information technology infrastructures and resident data, including the Internet, telecommunications networks, computer systems, and embedded processors and controllers (JP 3-12). Friendly, enemy, adversary, and host-nation networks, communications systems, cellular phone systems, social media, and technical infrastructures are all part of cyberspace.

3-70. Cyberspace has increasingly become a domain that will provide the capability for essential interactions between CA forces and the civil populace. Social media, internet-based radio stations, internet-based communications systems, and other advancements have enabled CA forces to conduct information collection, engagement opportunities, and influence activities using cyberspace resources. CND, CR, and CE might even be conducted through social media. Given the proper communications resources, CA forces are able to maintain near constant contact with IPI, multinational forces, unified action partners, NGOs, international organizations, and private entities while not being able to physically maintain a presence in that environment.

3-71. CMOCs utilize local social media and cyber networks to integrate, coordinate, and synchronize critical information to unified action partners and to ensure dissemination of civil knowledge to all required entities within the AO, thereby enabling unity of effort. Ensuring that CA forces are able to use the cyber domain

efficiently will help fill critical gaps in information requirements and relieve the supported command from providing critical communications to attached CA forces.

INFORMATION ADVANTAGE

3-72. CAO are designed to provide accurate, balanced, credible, and timely civil information to local officials, agencies, and external audiences. CA forces and CAO planners ensure CAO are consistent with the themes and messages of the command in order to ensure legitimacy and unity of effort. While the public affairs office, judge advocate general office, and Psychological Operations (PSYOP) forces are purveyors of messaging for the commander, CA forces enable messaging through dissemination of information to developed civil networks and other civil entities within the civil component of the AO. This dissemination of information enables developed civil networks to assist in the planning, preparation, execution, and assessment of targeted effects.

Information Operations

3-73. According to FM 3-13, CAO are an information-related capability. CAO are a capability that commanders employ to create effects and operationally desirable conditions. CA representation in the IO working group assists in—

- Identifying civil networks to target.
- Synchronizing communications media, media assets, and messages.
- Providing news and information to the local population.
- Provide civil knowledge.

3-74. CAO complement IO and facilitate mission accomplishment by enhancing the relationship between the civilian populace and the military force. CAO enhance or enable conditions that create a decisive advantage in the information decision making cycles. It is critical when CA forces are used to support IO, that CA forces maintain their credibility with the civilian populace.

Note: For more information regarding IO see FM 3-13.

Public Affairs

3-75. As an official spokesperson, the public affairs officer ensures—through established public affairs guidance—that the command speaks with one voice and observes operations security. CA, PSYOP, and public affairs elements use many of the same communications media and present similar messages to audiences for varied intended purposes. CA personnel engage IPI and unified action partners to influence, coordinate, and integrate their support for the command’s messaging. PSYOP personnel address friendly, neutral, and adversary populations to influence. Public affairs personnel address national and international news media and U.S. forces in order to inform.

Military Support to Information Operations

3-76. The importance of integrating CAO with the activities of PSYOP and public affairs personnel cannot be overstressed. For example, if information released to the host-nation populace by CA and PSYOP personnel conflicts with information released to news media and U.S. Soldiers through public affairs channels, the result may be a loss of credibility for all involved and a negation of any positive accomplishments.

COMPETITION CONTINUUM

3-77. Competition is the condition when two or more actors in the international system have competing and potentially incompatible interests but neither seeks to escalate to open conflict in pursuit of those interests. While violence is not the adversary’s primary instrument in competition, challenges may include a range of violent instruments including irregular forces with uncertain attribution to the state sponsor. This closely corresponds with the shape and prevent strategic roles and is where the vast majority of military operations

are actioned. Winning in competition is critical for the strategic interests of the U.S. government because it reduces the requirement to deploy and utilize combat forces to achieve diplomatic goals.

3-78. During competition, regional security is promoted by the forward presence of strategic land forces, accessing potential trouble spots, and enabling partner nations to participate in a community (or network) of partners to establish or maintain security and stability. CA forces are an economy of force effort to maintain awareness of conditions within an OE. CA forces augment and enable U.S. embassies or U.S. missions, joint force headquarters, or a theater Army by building the civil knowledge necessary for strategic leaders to make decisions.

3-79. CA forces identify critical civilian infrastructure status and capabilities, and areas of cultural significance (protected targets) in order to develop running estimates for mission analysis and course of action development. They also identify causes of instability within a civil society and identify potential threat networks as they develop within the society.

3-80. CA forces engage and develop friendly or neutral networks that enable rapid entry of other U.S. or coalition capabilities. These forces may also support civil administration during competition to help the country team develop democratic institutions or to address governmental sectors that CA forces have civil functional expertise to advise in.

3-81. ***Civil preparation of the environment*** is the continuous development of civil knowledge within an area of operations to help commanders identify capabilities within civil society that can be integrated with operations for stability and security activities. This minimizes the requirement for U.S. Army forces to conduct some of these actions and facilitates the maintenance or restoration of host-nation governance and legitimacy.

3-82. A critical strategy for winning in competition is through the provision of effective, responsive local governance. This strategy uses a whole of government approach which engages the diplomatic, information, military, and economic instruments of national power. CA forces develop and integrate mobilized civil networks that are in line with U.S. interests; deny space, resources, and capabilities to threat networks; and simultaneously provide governance, as directed, to address the hardships placed on the population due to the destruction of infrastructure during manmade or natural disasters. CAO degrade the freedom of action of threat networks, reduce their flexibility and endurance, and disrupt their plans and coordination.

3-83. Degrading access to the civil populace, resources, and capabilities places critical threat functions at risk, and denies threat elements the ability to synchronize or recruit from vulnerable populations. The application of CAO capabilities in a complementary and reinforcing manner with the instruments of national power creates critical problems for the threat element. These operations effectively reduce the ability to engage and mobilize a population in support of the ideals and goals of the threat networks, thereby eroding both the effectiveness and the will to fight of the threat network.

Chapter 4

Operations Structure

Intelligence about civil considerations may be as critical as intelligence about enemy forces.
ADP 5-0, *The Operations Process*

This chapter describes the CA role in Army operations through CAO planning, design, and capabilities within the operational framework and defines its integration into the Army's operational structure.

CA Soldiers, elements, and units are assigned to, have a command relationship with, or provide support to Army, joint force, coalition, and U.S. government civilian headquarters at the tactical, operational, and strategic levels. This chapter focuses on the CA role in Army operations. CA leaders and CAO planners must clearly understand the Army operations structure, planning, and orders production. They must understand the mechanics that underlie Army operations and the manner in which civil knowledge and CAO are integrated into the commander's intent, planning guidance, and CONOPS.

OVERVIEW

4-1. The operations structure consists of the operations process, combat power, and the operational framework. This is the Army's common construct for unified land operations. It allows Army leaders to organize efforts rapidly, effectively, and in a manner commonly understood across the Army. The operations process provides a broadly defined approach to developing and executing operations. The warfighting functions provide a common organization for critical functions. The operational framework provides Army leaders with conceptual options for arraying forces and visualizing and describing operations.

4-2. Planning is the art and science of understanding a situation, envisioning a desired future, and laying out effective ways of bringing that future about. Well-considered and developed plans lead to success. Plans for military operations are based on an imperfect understanding and uncertainty of how the military situation will evolve once the operation has started. CAO is one tool a commander uses to enhance understanding of the OE.

4-3. A plan does not guarantee mission success. Instead, a well-developed plan ensures the consideration of multiple competing factors within the OE, adherence to the commander's mission and intent, and the ability for leaders and Soldiers to be flexible and adaptable during implementation. In the military, decisive actions demand a flexible approach to operations that adapts methods to each situation. An effective planning process structures the thinking of commanders and staffs while supporting their insight, creativity, and initiative. Following this type of planning process—whether for offensive, defensive, stability, or DSCA operations—offers the best opportunity for mission success.

CIVIL AFFAIRS ROLE IN THE OPERATIONS PROCESS

4-4. Commanders organize forces according to purpose by determining whether each unit's operation will be decisive, shaping, or sustaining. These decisions form the basis of the CONOPS of the commander through the MDMP and METT-TC analysis. Through the MDMP and evaluation of METT-TC variables, the CAO planner recommends the allocation of CA forces in support of operations. During MDMP, the CAO staff integrates civil knowledge into the process to enhance the understanding of the OE in which they are planning operations. This information is then shared with the commander and staff for that OE. At each stage of MDMP there are specific inputs for civil considerations of the OE which help to drive the decision-making process.

CIVIL KNOWLEDGE INTEGRATION INPUT TO THE MILITARY DECISION-MAKING PROCESS

4-5. The organic or attached CAO staff at maneuver and maneuver support units are responsible for the integration of civil knowledge into the MDMP. Civil knowledge that is an output from the CNDE and CKI processes flows to the CAO staff elements from the supporting CA units and teams. The CAO staff then ensures that actionable civil knowledge is applied throughout the MDMP to synchronize, coordinate, and integrate civilian capabilities and activities with all other staff processes to promote unity of effort in the development of the commander's plan.

4-6. Through CNDE and CKI, CA personnel develop civil information and knowledge. Through CKI, that knowledge is assessed for operational relevance and integrated into the MDMP. A greater understanding of the interests, functions, capabilities, and vulnerabilities of the resident population, government institutions, and interorganizational partners allow for more precise courses of action for the commander as a guide for mission planning. Figure 4-1 shows where those inputs fit into the MDMP.

Step in MDMP	Inputs	Outputs
Step 1 Receipt of Mission	<ul style="list-style-type: none"> Higher headquarters' plan or order of a new mission anticipated by the commander. Open source resources. <i>Initial estimate.</i> 	<ul style="list-style-type: none"> Initial guidance from commander. Initial allocation of time. <i>Review of area study.</i>
Step 2 Mission Analysis	<ul style="list-style-type: none"> Higher headquarters' plan or order. Higher headquarters' knowledge and intelligence products. Knowledge products from other organizations. Army design methodology products. <i>Civil considerations from the area study.</i> <i>CA input to restated mission statement.</i> <i>Identifications of mission and operational variables and potential centers of gravity.</i> <i>Trend verification.</i> <i>Civil vulnerability identification.</i> <i>Layered geospatial information.</i> <i>Civil information for the common operational picture.</i> 	<ul style="list-style-type: none"> Problem statement. Mission statement. <i>Initial assessment.</i> Initial commander's intent. Initial planning guidance. Initial CCIRs and critical information. Updated IPB and running estimates. <i>Initial CAO running estimate.</i> Assumptions. Restated mission statement. Identification of civil information requirements.
Step 3 Course of Action Development	<ul style="list-style-type: none"> Mission statement. Initial commander's intent, planning guidance, CCIRs, and critical information. Updated IPB and running estimates. Assumptions. <i>CAO running estimate.</i> <i>Continued and refined center of gravity analysis.</i> 	<ul style="list-style-type: none"> CAO statements and sketches such as— <ul style="list-style-type: none"> Tentative task organization. <i>Tactical tasks assigned to CA forces.</i> Broad concept of operations. <i>CAO concept of support.</i> Revised planning guidance. <i>Updated CAO running estimate.</i> Updated assumptions. <i>Identification of MOEs and MOPs.</i> <i>Identification of center of gravity.</i> <i>Initial civil information collection plan.</i>

Figure 4-1. Civil Affairs inputs and outputs in the military decision-making process

Step in MDMP	Inputs	Outputs																				
Step 4 Course of Action Analysis	<ul style="list-style-type: none"> • <i>Refined and updated center of gravity analysis.</i> • Updated running estimates. • Revised planning guidance. • Course of action statements and sketches. • Updated assumptions. • <i>Updated CAO running estimate.</i> • <i>Tactical tasks assigned to CA forces.</i> • <i>Civil information collection requirements.</i> 	<ul style="list-style-type: none"> • Refined courses of action. • Potential decision points. • <i>Civil considerations for wargaming.</i> • War game results. • Initial assessment measures. • Updated assumptions. • <i>Refined civil information collection plan.</i> 																				
Step 5 Course of Action Comparison	<ul style="list-style-type: none"> • <i>Center of gravity analysis.</i> • Updated running estimate • Refined courses of action. • Evaluation criteria. • War game results. • Updated assumptions. • <i>Civil considerations from initial assessment.</i> • <i>CAO concept of support.</i> 	<ul style="list-style-type: none"> • Evaluated courses of action. • Recommended courses of action. • Updated running estimates. • <i>Updated CAO running estimate.</i> • Updated assumptions. 																				
Step 6 Course of Action Approval	<ul style="list-style-type: none"> • Updated running estimates. • Evaluated courses of action. • Recommended course of action. • Updated assumptions. 	<ul style="list-style-type: none"> • Commander-selected course of action and any modifications. • Refined commander's intent, CCIRs, and critical information. • Updated assumptions. 																				
Step 7 Production, Dissemination, and Transition of Orders	<ul style="list-style-type: none"> • Commander-selected course of action with any modifications. • Refined commander's intent, CCIRs, and critical information. • Updated assumptions. • <i>Refined CAO concept of support.</i> • <i>Tasks to CA forces.</i> • <i>Civil information collection requirements.</i> 	<ul style="list-style-type: none"> • Approved OPLAN or OPORD that— <ul style="list-style-type: none"> ▪ <i>Produces Annex K.</i> ▪ <i>Assists in the production of Annex V.</i> • Understanding of plan or order by subordinates. • <i>Revised civil information collection plan.</i> • <i>Any CA-specific FRAGORDs.</i> • <i>Updated restricted target list.</i> • <i>Updated no-fire area.</i> 																				
<p>Note: Purple italicized text denotes CA requirements.</p> <p>Legend:</p> <table> <tr> <td>CA</td> <td>Civil Affairs</td> <td>MDMP</td> <td>military decisionmaking process</td> </tr> <tr> <td>CAO</td> <td>Civil Affairs operations</td> <td>MOE</td> <td>measure of effectiveness</td> </tr> <tr> <td>CCIR</td> <td>commander's critical information requirement</td> <td>MOP</td> <td>measure of performance</td> </tr> <tr> <td>FRAGORD</td> <td>fragmentary order</td> <td>OPLAN</td> <td>operation plan</td> </tr> <tr> <td>IPB</td> <td>intelligence preparation of the battlefield</td> <td>OPORD</td> <td>operation order</td> </tr> </table>			CA	Civil Affairs	MDMP	military decisionmaking process	CAO	Civil Affairs operations	MOE	measure of effectiveness	CCIR	commander's critical information requirement	MOP	measure of performance	FRAGORD	fragmentary order	OPLAN	operation plan	IPB	intelligence preparation of the battlefield	OPORD	operation order
CA	Civil Affairs	MDMP	military decisionmaking process																			
CAO	Civil Affairs operations	MOE	measure of effectiveness																			
CCIR	commander's critical information requirement	MOP	measure of performance																			
FRAGORD	fragmentary order	OPLAN	operation plan																			
IPB	intelligence preparation of the battlefield	OPORD	operation order																			

Figure 4-1. Civil Affairs inputs and outputs in the military decision-making process (continued)

CIVIL KNOWLEDGE INTEGRATION IN THE INTEGRATING PROCESSES OF THE ARMY

4-7. CKI is executed by performing analysis and evaluation of civil information and data for operational relevance and integrating the resulting actionable civil knowledge into the Army's integrating processes. These integrating processes include—

- IPB.
- Information collection.
- Targeting.
- RM.
- Knowledge management.

4-8. The integration of civil knowledge allows commanders to increase their situational understanding of the OE and allows staffs to produce plans and operations orders armed with the most accurate and current understanding of the civil component of the OE. As missions intersect with varying types of civilian activity, this increased understanding is essential to enable unified action at all echelons and achieve the mission, goals, and end state of the commander.

CIVIL PREPARATION OF THE BATTLEFIELD

4-9. *Civil preparation of the battlefield* is the systematic process of analyzing civil considerations in an area of interest to determine their effects on friendly, neutral, and enemy operations. The role of CA forces is to engage and leverage the civil component of the OE while enhancing, enabling, or providing governance. This systematic process is informed by IPB and also informs IPB and these integrating processes are critical to the development of the common operational picture.

4-10. CPB is conducted by all CA forces at all echelons, is critical to informing the CNDE process, and provides direction for the engagement and development of specific civil networks. CPB analyzes and evaluates the political, economic, and social operational variables in an area of interest to determine opportunities and risks in an AO. The goal is to provide the commander with the capability to enhance, enable, or provide governance. The analysis and evaluation of civil information gained through CNDE, area studies, initial and deliberate assessments, and other CA processes, is developed into civil knowledge. CA forces integrate civil knowledge into CAO and all Army planning processes and use this civil knowledge to inform the warfighting function. This civil knowledge—

- Provides commanders with a greater situational understanding of the OE.
- Enables the commander's visualization of the battlefield.
- Provides options that facilitate decision making and enables information advantage.
- Allows planners to develop effective plans and operations.

INTELLIGENCE PREPARATION OF THE BATTLEFIELD

4-11. *Intelligence preparation of the battlefield* is the systematic process of analyzing the mission variables of enemy, terrain, weather, and civil considerations in an area of interest to determine their effect on operations (ATP 2-01.3). IPB is normally led by the S-2 or G-2, or the intelligence functional cell—with staff participation from all functional and integrating staff cells. The CAO staff provides operationally relevant civil knowledge to the S-2 or G-2 within the fusion cell of the command (where civil knowledge is used to inform IPB). Within the IPB process, analysts examine information and knowledge related to predetermined and evolving civil information requirements. These civil information requirements include the effect of sociocultural factors within a particular geographic area, the availability of critical resources for use by military or civilian activities, and the efficiency of integration of important or influential civil network structures in achieving mission objectives.

4-12. Civil considerations of ASCOPE assist commanders in refining their understanding of the operational variables of PMESII-PT and mission variables of METT-TC within the AO. CAO staff integrate civil knowledge into the IPB process to increase understanding of civil considerations and identify risk to mission.

4-13. Understanding the relationship between military operations, populations, local governance structures, properties of cultural significance, and other aspects of the OE is essential to developing effective plans and conducting successful operations. Combat operations directly affect the population, infrastructure, and the ability of the force to transition authority to local control. The degree to which the population is expected to support or resist U.S. and friendly forces also affects the offensive and defensive operational design. Commanders and staffs use personal knowledge, civil knowledge gained from CA forces and staff, and running estimates to assess social, economic, and political factors.

4-14. Commanders consider the relationship between these factors as they relate to illicit activities such as lawlessness, subversion, or insurgency that adversely affect the operation. Commanders then use this understanding to estimate the effects of friendly actions, predict potential outcomes, and direct subordinates.

INFORMATION COLLECTION

4-15. Information consists of data, in context, to inform or provide meaning for action. *Information collection* is an activity that synchronizes and integrates the planning and employment of sensors and assets as well as the processing, exploitation, and dissemination of systems in direct support of current and future operations (FM 3-55). CA forces are a valuable information collection and management capability because of their interaction with populations, government institutions, and inter-organizational partners.

4-16. CA forces collect information through physical engagements such as CR, CEs, area studies, and assessments. When physical meetings cannot take place due to constraints within the OE, these meetings can be done via computer or cell phone resources. CR, and CE can be conducted using satellites, computer links, or cell phone resources. This is done in the virtual context. CA forces also collect information through integration, coordination, and synchronization with unified action partners.

4-17. CA forces collaborate with other information-related capabilities within the information environment to ensure synchronization of information collection to meet the priorities of the commander. The S-9 or G-9 CAO staff officer develops a civil information collection plan that supports the information requirements of the commander or fulfills information gaps in the CA area study. This collection plan is passed down to the lowest echelons, allowing for collection plans to be developed down to the CAT level.

TARGETING

4-18. According to JP 3-0, targeting is a complex and multidisciplinary effort that requires coordinated interaction among many command and staff elements. The functional elements necessary for effective collaboration participate in the targeting working group.

4-19. CA forces provide commanders with options for engagement of the civil component of the OE by utilizing CATs and partner civil networks. This engagement capability empowers commanders with courses of action to produce nonlethal effects in the civil component of the OE. Through CKI, supported commanders are provided with actionable civil knowledge, which is needed to identify and produce—

- Targeted lethal and nonlethal effects in the civil component with the least amount of force.
- Least disruption to the population.
- The most efficient use of finite resources and capabilities.
- Leverages in the capabilities and resources of the civil network.

RISK MANAGEMENT

4-20. The Army uses RM to help maintain combat power while ensuring mission accomplishment in current and future operations. The Army also uses RM to reduce collateral damage to civilians, critical infrastructure, and noncombatants. According to JP 3-0, hazards create the potential for harmful events that cause degradation of capabilities or mission failure.

4-21. CAO staff analysis identifies threats to military operations and hazards to the force that emerge from within the civil component or that will affect the interests, functions, or capabilities of civil sector groups or organizations. For example, the presence of a large civilian population and its daily activities may create hazards to U.S. forces during operations. High civilian traffic densities may present hazards to convoys and maneuver schemes. Planners must assess such diverse elements as insurgents, riots, and criminal activity that emerge from civil society. Legal, regulatory, or policy considerations may introduce hazards that affect operations and other activities. Commanders and staffs must also weigh the importance of protecting civilians from violence during operations.

KNOWLEDGE MANAGEMENT

4-22. Knowledge management is performed by the staff to enhance the commander's understanding and support the commander's decision making. Knowledge is information that has been analyzed to provide meaning or value and is evaluated for operational implications. CA forces enhance the knowledge management process by producing civil knowledge through CKI. Civil knowledge is produced by analyzing and evaluating civil data and civil information gained through engagement with civil networks, through CR

and CE, and through conducting area studies and assessments. CAO staff, at all echelons, integrates civil knowledge into the operations process in order to create a common understanding of the mission and OE.

STAFF INTEGRATION

4-23. The commander's intent links the mission, CONOPS, and tasks to subordinate units. CAO staff integrates the capabilities of supporting CA forces into the operation plan in support of the commander's intent. CAO staff also integrate civil knowledge gained through CNDE, CKI, and CMI into the operational planning cycle of the commander all the way through execution of CKI. Paragraph 3 (Execution) of Annex K (Civil Affairs Operations) to the operation plan of the supported command addresses the CAO scheme of support and subordinate unit tasks. Paragraph 3 of Annex K also coordinates instructions that CA and other Army forces execute to accomplish the commander's intent. The execution paragraph outlines what the supported commander wants CAO to achieve in support of the mission.

4-24. CA forces execute TG, CNDE, CKI, and CMI to enhance the understanding of the OE, visualization of the battlefield, and decision-making of the commander and staff so that they may accomplish missions and achieve unified action. In the absence of an integrated CA staff, CA forces assigned by echelon will be required to conduct the CAO planning requirements. The following CA elements provide direct input to, or augment, the planning process:

- Assistant chief of staff, CAO (G-9).
- Battalion and brigade CAO staff officer (S-9).
- Civil-military operations directorate of a joint staff (J-9).
- Theater CAPT.
- CAPT.
- CAO working groups.
- Security force assistance brigade CAO staff section.
- CA company staff.
- CMOC staff.
- CATs.

ASSISTANT CHIEF OF STAFF, CIVIL AFFAIRS OPERATIONS AND CIVIL AFFAIRS OPERATIONS STAFF OFFICER

4-25. The G-9 or S-9 is the dedicated principal staff officer position, from battalion through theater Army, responsible for all matters concerning CAO. The G-9 or S-9 is required at all echelons—from brigade combat team (BCT) through theater Army, and in special operations formations at battalion and group. Roles of the G-9 or S-9 include—

- Evaluating civil considerations during mission analysis.
- Recommending the establishment of a CMOC in conjunction with the supporting CA unit commander.
- Working with interorganizational partners to prepare the groundwork for transitioning the AO from military to civilian control.
- Advising the commander and staff on the effect of military operations on civilians in the AO relative to the complex relationship of these people with the terrain and institutions over time.
- Advising the commander on options for CA units to engage and influence civil networks and the population in order to produce desired effects in the civil component of the OE.
- In coordination with the supporting CA unit commander, maintaining responsibility for developing plans and operations that enhance the relationship between Army forces and the civil authorities and people in the AO.
- Preparing Annex K of the operation order or operation plan.

4-26. During the MDMP, the G-9 or S-9 provides the commander with an analysis of the civil factors that shape the OE. As a part of mission analysis, the METT-TC mission variables are evaluated for those aspects of the OE that directly or indirectly affect a mission. The CAO staff provides the commander with a detailed civil considerations analysis which focuses on how ASCOPE affects the civil component of the AO.

CAO planners further develop and implement their plans in conjunction with civilian officials from other USG departments and agencies and participating nonmilitary organizations in order to synchronize U.S. and multinational efforts. Responsibilities of the G-9 or S-9 include—

- Enhancing the conduct of CAO by integrating the capabilities of a CA government function specialty skills into areas which are normally the responsibility of civil government.
- Evaluating civil information and data in collaboration with other staff entities to develop civil knowledge and to advise the commander on recommended courses of action.
- Ensuring civil knowledge is integrated with supporting CA elements.
- Ensuring civil knowledge, in conjunction with CMI, is integrated with unified action partners to achieve unity of effort.
- Coordinating with the fires support officer on the restricted target list, which should include cultural, religious, historical, and high-density civilian populace areas.
- Participating in the fires targeting board.
- Providing options for producing effects in the civil component of the OE.
- Providing the intelligence staff officer information gained from civilians in the AO and information gained about the civil component of the AO.
- Coordinating with the surgeon on the military use of civilian medical treatment facilities, materials, and supplies.
- Coordinating with the IO officer to ensure planned activities are synchronized and disseminated and information is not contradictory.
- Coordinating with the public affairs officer on supervising public information media under civil control.
- Providing instruction to units on identifying, planning, and implementing programs to support civilian populations and strengthen internal defense and development.
- Identifying and assisting the assistant chief of staff, signal or the battalion or brigade signal staff officer with military use of local information systems.
- Coordinating with the provost marshal to control civilian traffic in the AO.
- Assisting the G-4 or S-4 in identifying and procuring services, facilities, supplies, and other materiel resources available from the civil sector to support operations.
- Analyzing and evaluating the effects of civilian activities on military operations.
- Analyzing and evaluating the effects of military operations on the HN and its population.
- Analyzing HN evacuation plans to propose DC movement, routes, and assembly areas.
- Assessing the ability of the IPI to care for civilians.
- Assessing the IPI resources to support military operations.
- Identifying private sector, NGOs, and other independent organizations operating in the AO.
- Identifying U.S. departments and agencies in the AO and their objectives, capabilities, and activities.
- Preparing the CAO annex and its attachments.
- Preparing the CAO running estimates.
- Participating in boards, groups, centers, and cells to integrate the analysis of civil considerations.
- Planning for and determining the requirements and priority of the distribution of Class X across the civil component.
- Coordinating with the G-4, S-4 or, functional quartermaster organization for the storage and movement of Class X.
- Coordinating with the division or corps transportation officer to deconflict humanitarian assistance convoys.
- Providing guidance for the civil information collection plan.

THEATER CIVIL AFFAIRS PLANNING TEAM

4-27. The theater CAPTs are five regionally-assigned planning teams, consisting of five CA planners assigned to a theater Army with duty at their respective geographic combatant command. The role of the

theater CAPT is to provide a dedicated CAO planning capability. At geographic combatant commands that have an established J-9, the theater CAPT is a critical capability that serves to strengthen the directorate's efforts. The J-9 and theater CAPT develop, integrate, synchronize, and coordinate CAO plans, policies, programs, and operations with theater-aligned CA forces and interagency entities. These are integrated with and enhance the geographic combatant command's strategic plans, campaigns or operations, and theater security cooperation initiatives. Responsibilities of the theater CAPT include—

- Developing, integrating, synchronizing, and coordinating strategic and operational-level CAO into theater campaign and contingency plans in all phases of operations.
- Developing—from civil knowledge—the strategic-level civil component factors that inform operational variables (PMESII-PT) and incorporating them into the joint planning process.
- Advising and assisting combatant and Service component commanders to develop, implement, assess, and execute theater-level, population-centric policies, strategies, and plans for confronting challenges to U.S. national security interests across the competition continuum.
- Providing theater-level analysis and evaluation of civil strengths and vulnerabilities based on operational variables.
- Liaising across military and civilian organizations.
- Participating with and supporting the joint interagency coordination group or joint interagency task force if either is part of the joint staff.
- Assisting the CCDR and staff to—
 - Integrate stability activities and considerations into their theater campaign plans, theater strategies, and applicable DOD-directed plans.
 - Incorporate stability activities and concepts into training, exercises, and experimentation.
 - Incorporate military government operations into training, exercises, experimentation, and planning.

CIVIL AFFAIRS PLANNING TEAM

4-28. CA forces, from battalion through CACOM, organic CAPTs. These dedicated planning elements are designed to meet specific mission requirements. They are also designed to be assigned or attached to the commander and staff to assist with CMO planning; develop and incorporate CA plans, policy, and programs, and to assist with CAO planning (including planning for stability activities and military government). CAPTs support the CMO staff of the joint force commander (JFC) and other military planners throughout the joint planning process and are normally assigned or attached for operations. Responsibilities of the CAPT include—

- Integrating civil knowledge—derived from analysis and evaluation of civil networks and civil information affecting the civil component of the AO—into planning.
- Developing, from civil knowledge, the strategic-level civil component factors that inform the operational variables of PMESII-PT and incorporating it into the MDMP or the joint planning process.
- Developing annexes in support of current operations and contingency plans.
- Developing, integrating, synchronizing, and coordinating strategic and operational-level CAO into theater campaign and contingency plans in all phases of operations.
- Advising and assisting combatant and Service component commanders to develop, implement, execute, and assess theater-level and population-centric policies, strategies, and plans for confronting challenges to U.S. national security interests across the competition continuum.

CIVIL AFFAIRS OPERATIONS WORKING GROUP

4-29. Commanders may establish a CAO working group for bringing all the stakeholders together to focus and synchronize their efforts in achieving the priorities of the commander. In addition to the CAO working group, CAO planners ensure that they are actively involved in the IO working group; the intelligence fusion working group; the targeting board; and other boards, cells, or working groups relevant to the current operation.

4-30. The composition of the working group changes based on the level of command, but the G-9 or S-9 should chair the group. Other members of this working group may include the following:

- Government sector functional specialists.
- Director, CMOC.
- CA unit representatives.
- Targeting working group.
- IO representative.
- Medical representative.
- Engineer representative.
- Provost marshal or representative.
- Staff judge advocate representative with expertise in CMO, preferably the unit's senior rule of law officer.
- Chaplain or religious affairs noncommissioned officer.
- Interagency representative, if applicable.
- Political advisor, if applicable.
- Public affairs officer.
- S-2, G-2, or J-2 targeting officer representative.
- S-3, G-3, or J-3 current operations representative.
- S-4, G-4, or J-4 logistics representative.
- S-5, G-5, or J-5 plans representative
- Resource management representative.
- Subordinate liaison officer.

4-31. As these lists (and the doctrinal publications that discuss them) are not all inclusive, CA professionals should constantly assess the battle rhythm of the units they are assigned to, attached to, or supporting in order to identify those opportunities to engage and provide input to best support the mission of the commander. Some additional Army and joint boards, groups, centers, and cells are listed below:

- Rules of engagement or rules for the use of force working group.
- Emerging planning teams.
- Assessment working group (plans or future operations cell).
- Operations and intelligence working group (intelligence cell).
- Protection working group (protection cell).

SECURITY FORCE ASSISTANCE BRIGADE CIVIL AFFAIRS OPERATIONS STAFF SECTION

4-32. The security force assistance brigade CAO staff section is responsible for—

- Training and advising foreign security force counterpart staff elements to enable them to build rapport with IPI, civilian unified action partners, and independent foreign agencies.
- Enhancing foreign security forces capabilities to assess interests, functions, capabilities, and vulnerabilities of IPI, civilian unified action partners, and independent foreign agencies.
- Integrating civil knowledge into all CAO and Army planning processes.
- Ensuring CPB outputs are integrated into other staff functions.
- Training foreign security forces to plan and conduct FHA projects that reduce civilian vulnerabilities to security and environmental threats.
- Providing liaison between the security force assistance brigade and the country team.
- Establishing relationships with civil component entities in the area of interest of the security force assistance brigade.
- Assisting in identifying and coordinating host-nation support resources for security force assistance brigade mission support.
- Identifying and monitoring civil considerations in the area of interest of the security force assistance brigade and assessing their impact on the mission of the security force assistance brigade.

- Promoting the legitimacy of the missions of the security force assistance brigade and the foreign security force among the IPI.
- Understanding civil knowledge of the civil component to update the common operational picture.

4-33. Understanding the civil component of the OE requires comprehension and analysis of civil considerations within METT-TC. Civil considerations reflect the influence of human-made infrastructure; civilian institutions; and attitudes and activities of the civilian leaders, populations, and organizations within an AO on the conduct of military operations. CAO staff organizes data collection for mission analysis according to groupings of ASCOPE (for example, cities and population sizes, resources, capacities, ethnicities, and cultural nuances as they apply to the IPI). CAO planners and staff must understand the strengths, vulnerabilities, opportunities, and threats of the civil component with respect to each category represented by ASCOPE.

4-34. Army forces use operational variables to understand, analyze, and evaluate the broad environment in which they are conducting operations. They use mission variables to focus analysis on specific elements of the environment that apply to their mission. Military planners describe the OE in terms of operational variables. Operational variables describe the military aspects of an OE and the population's influence on it. Joint doctrine identifies the operational variables as political, military, economic, social, information, and infrastructure (PMESII). U.S. Army doctrine adds two variables to the joint variables, physical environment, and time (PT), to make PMESII-PT.

4-35. The application of the elements of ASCOPE during civil considerations analysis identifies the key and decisive civil areas, structures, capabilities, organizations, people, and events of each operational variable. For example, analysts would apply ASCOPE to the entire concept of economics. The staff would ask the questions—

- Where are the key and decisive areas of economic activity?
- Where are the key and decisive structures associated with economic activity?
- What are the key and decisive economic capabilities that forces must engage and restore (for example, banking)?
- What are the key and decisive economic organizations?
- Who are the key and decisive economic people?
- What are the key and decisive economic events?

4-36. These questions would lead to effective CAO supporting plans to the CONOPS of the commander, identify measures of effectiveness, and provide the basis for troops-to-task analysis.

4-37. An operational and mission variable analysis approach integrates people and processes by using multiple information sources, collaborative analysis, and evaluation to build a common, shared, holistic knowledge base of the OE. Operational variable analysis emphasizes a multidimensional approach toward situational understanding, distinguished by an analysis of the six interrelated characteristics of ASCOPE within each variable. Table 4-1 depicts a PMESII/ASCOPE analysis.

Table 4-1. Example of political, military, economic, social, information, and infrastructure/areas, structures, capabilities, organizations, people, and events analysis

	P	M	E	S	I	I
A	National, provincial, district and municipality borders and boundaries and party and tribal affiliation areas	Designated areas of responsibility, jurisdictions, key terrain, security boundaries, Coalition bases, historic ambush	Land use, natural resources financial services, markets, cities, agricultural, mining, manufacturing, salvage yards, import/export	Religious, economic, and ethnic demographics, population centers tribal boundaries, traditional meeting sites, national and local parks	Radio, Television, internet service areas, word of mouth, newspaper, graffiti	rivers and estuaries, electric service area/grid, sewer networks, water tables, irrigation networks, water distribution systems
S	Infrastructure from which any level of governance or political activity is perpetuated including National, Provincial and district centers, government or political buildings, meeting halls	Operating bases, provincial/district police headquarters and buildings, border points of entry, gang locations, militia, enemy or insurgent bases	Commercial centers, banks, energy infrastructure, transportation (highways, rail, ports, airports), processing plants	Parks, club houses, sport facilities, religious structures, historic/cultural/ archeological sites, informal gathering places, universities schools, courthouses	Radio, television, satellite reception, internet systems, transmission facilities and relays, print shops, internet cafes	Interstate system, rail system, power generators secondary and tertiary roads, government buildings, banks, schools
C	Influence control or communication between the governed and the governing. Monetary policy, Fiscal policy, informational distribution	Response times, training, aircraft and boats number and type of personnel, security, offense and defense weapons	Land ownership, land use, water resources controls, energy resources controls, food production, raw material mining	Economic class system, social mobility, tribal influences, religious influences, support networks	Social media, internet, telephone, radios or television per household, printing abilities, literacy rate	Commodity market interstate commerce, regional economic zones, jail/prison capacity, emergency services
O	Political parties or opposition, Regional collective security organizations or alliances, religious, intergovernmental organizations, nongovernmental organizations	Coalition/host-nation Army, Navy, Air Force, Marines, border police, highway police, municipal police, national police, national investigation services, gangs	Ministries, criminal organizations national commodity exchange, trading guilds, banks, money exchanges, government support agencies	Religious, educational, and advocacy groups, relief organizations, government ministries, police, worship, tribal, family, sports, clubs	News networks, religious organizations, ministry of public affairs, religious, tribal, political and government businesses	Ministries, unions, construction firms, medical and Transportation companies
P	Key leaders, Formal and informal political leaders, religious leaders, judges, clergy	Defense and coalition leaders, ministries, morale of members, commanders, police chiefs, tribal leaders	Business leaders, ministers, banks, non-state entities, business owners, labor leadership, poverty level, foreign investors, landholders, money lenders, criminals	Political leaders, minorities, influential families, religious leaders, tribal or village elders, key mentors with social influence	Media owners, reporters, influencers, Religious leaders, teachers, prominent families, tribal leaders	Civil servants, builders, contractors, local development councils, engineers
E	Elections, tribal gatherings, provincial council meetings, protests and speeches, religious gatherings, political meetings, rallies, trials, debates	Lethal events, loss of leadership, operations, peace operations support, attacks, crime, riots, political and labor unrest, regional meetings	Elections, holidays planting seasons harvest seasons drought, flood, rain, snow fall or melt cycles, financial crisis, business activity, agricultural activities, weather	Days of worship, holidays, holy days, births, weddings, deaths and bazaar days, traditional holidays, state holidays, religious holidays, gatherings, festivals	Days of worship, media publishing dates, project openings, civilian casualty events, opening and closing of media outlets, information media	Medical, police, transportation, Disruptions of Service, major construction projects or capability/capacity increases
Legend:						
ASCOPE areas, structures, capabilities, organizations, people, and event						
PMESII political, military, economic, social, information and infrastructure						

MISSION VARIABLES

4-38. During the planning process, CA planners at each echelon provide the commander with analysis and evaluation of the civil aspects that shape the OE using the evaluation tool known as ASCOPE. The CAO staff apply the METT-TC mission variables, concentrating on the “C” as the civil considerations aspect of the AO during conduct of the MDMP. This is similar to how observation and fields of fire, avenues of approach, key terrain, obstacles, and cover and concealment evaluate the physical terrain of METT-TC. The six characteristics of ASCOPE are discussed in FM 6-0.

OPERATIONAL VARIABLES

4-39. The conditions of an OE are described in terms of operational variables. Operational variables describe not only the military aspects of an OE, but also the population’s influence on it. Army planners analyze an OE in terms of eight interrelated operational variables: political, military, economic, social, information, infrastructure, physical environment, and time—PMESII-PT. Joint planners use only the initial six variables, not including physical environment and time.

4-40. The operational variables provide the commander with a systems perspective of the OE. A systems perspective facilitates Army design methodology and provides the staff with a common frame of reference for collaboration with unified action partners. Civil data and information for each of these variables that has been transformed into civil knowledge informs the IPB process, warfighting functions, and the common operational picture through CKI.

Note: JP 5-0, JP 3-24, JP 3-57, ADP 5-0, and FM 3-24 provide additional information on operational variables.

SYNTHESIZING OPERATIONAL AND MISSION VARIABLES

4-41. A fully developed collaborative environment comprised of individuals, organizations, knowledge management systems, infrastructure, and processes to create and share the data, information, and knowledge is ultimately desired in order to plan, prepare for, execute, and assess operations. Commanders seek to make informed decisions faster to achieve decision advantage over the enemy or adversary. Commanders and staffs require the capability and capacity to create a shared understanding.

4-42. Knowledge management techniques and procedures support collaboration within the headquarters, agency, interagency, and subordinate unit. These techniques and procedures must encompass the processes and databases to integrate and synchronize the command and staff activity to generate orders that support information and CA products. Integration of civil knowledge through the CKI process, automation, and decision-support capabilities all enhance the efficiency of the battle rhythm of the organization and the commander’s decision making. The collaborative environment must provide the right information, to the right people, at the right time, and in an understandable and actionable format or display.

4-43. CA forces prepare area studies, conduct assessments, and create and maintain running estimates to assist in the planning and updating of mission plans across the competition continuum. CA-produced area studies, assessments, and running estimates include geo-references. These geo-references allow for future geospatial application of these products into operations and mission planning sequences. These products develop and update the understanding of the civil component for the common operational picture of the commander. The information and material contained within these products are critical for the situational understanding of the commander and the staff and the formation of the commander’s vision for the OE. This information includes—

- Identification and reinforcement efforts to consolidate gains.
- Information requirements that drive and focus the civil information collection plan.
- Impacts of civilian activities on military operations.
- Impacts of military operations on resident civilian populations, government institutions, and interorganizational partners.
- Development of courses of action.

- Development of branches and sequels.
- Completion of objectives, goals, and milestones.
- The transition of Army operations across the competition continuum or to follow-on military or civilian organizations.

CIVIL INFORMATION COLLECTION PLAN

4-44. *Information requirements* are, in intelligence usage, those items of information regarding the adversary and other relevant aspects of the operational environment that need to be collected and processed in order to meet the intelligence requirements of a commander. (JP 2-0). Commanders cannot successfully accomplish activities involved in the operations process without the necessary information to make informed decisions. CND, CR, CE, CNA and evaluation, and data mining (the collection of information from a combination of open- and restricted-source materials for routine and continuous study and research) should be focused on specific civil information requirements and synchronized into the civil information collection plan. For the purposes of the mission command, a validated civil information collection plan establishes requirements that, when answered, will fill a gap in knowledge and understanding of the civil component through analysis and evaluation of civil considerations within an AO and the area of interest.

4-45. CND, CR, and CE fill identified gaps or requirements in the civil information collection plan and may be conducted concurrently with other operations. The commander's intent, priority intelligence requirements, and the CCIRs focus CAO and the civil information collection plan. In return, CA forces execute CKI to provide the operations process with a continual flow of essential and actionable civil knowledge during offensive, defensive, and stability operations. This civil knowledge enables CA forces to conduct CAO that effectively identify and assess civil strengths and vulnerabilities in order to provide commander-driven effects in the civil component, thereby enabling U.S. military forces to achieve decisive results.

Note: FM 3-55 provides the fundamentals of information collection.

AREA STUDIES

4-46. CA personnel obtain, analyze, evaluate, and record information in advance of the need. The basic evaluation of an area is the CA area study that establishes baseline information relating to the civil components of the area in question. The CA area study is a pre-mission study prepared regionally, by country, or for a specific subnational area within a country, as the baseline research document for CA operational planning. The CA area study presents a description and analysis of the geography, historical setting, and the social, political, military, economic, health, legal, education, governance, infrastructure, and national security systems and institutions of a country. The CA area study uses a combination of open- and restricted-source materials and, when possible, interviews of people who recently operated in the area. CA personnel update the information detailed in the CA area study periodically, as required, prior to the receipt of a mission. CA requires the ability to retrieve accurate and current data on demand. This requirement necessitates a system to capture, store, collate, and produce this data in the form of a report, which is comprised of all available collected data at any given time.

4-47. This baseline information is used as the basis for the creation of the CAO running estimate during the planning process. If an area study for a particular area does not already exist, then the CA force must use all available resources to develop a hasty study during mission preparation and planning. If unable to develop a hasty study, it must use similar research and analysis techniques to produce the initial CAO running estimate, which will be continuously updated over time.

CIVIL AFFAIRS ASSESSMENTS

4-48. CA assessments provide a precise means to collect meaningful and significant civil information. CA Soldiers perform three basic types of assessments—the initial assessment, the deliberate assessment, and the survey. Each type of assessment is based upon civil information, requirements necessary to understand actual conditions on the ground, and a refinement of information available in previous assessments. In addition, each type of assessment in the progression becomes more focused, specific, and

detailed with an ultimate goal of identifying civil interests, functions, capabilities, and vulnerabilities that affect mission outcomes.

4-49. During continuous operations, the results of each type of assessment must be shared and passed on to follow-on CA forces to preclude wasting time, resources, effort, and good will associated with over-assessing target facilities, organizations, and individuals. As with all military missions, this task must have a well-formed, practical plan.

INITIAL ASSESSMENTS

4-50. The initial assessment is conducted upon initial entry into a designated AO and every time a CA unit moves into a new area not covered by previous assessments. The objective and focus of the initial assessment should be broad enough to allow CA forces to quickly obtain an updated baseline of the general conditions within the entire AO. This allows CA forces to validate or refute the information and assumptions of the area study used in planning, and to update the CAO priorities and civil information collection plan. CATs conducting initial assessments must always be aware of the security situation.

DELIBERATE ASSESSMENTS

4-51. Deliberate assessments are conducted in a methodical manner in accordance with CAO priorities, and against specific civil information requirements. They are a determination of current conditions, capabilities, or attitudes within defined geographic areas or social, economic, governmental, or infrastructure systems of interest. Deliberate assessments are characterized by firsthand observations, interviews, and other tools to collect information used to make knowledgeable decisions and to determine locations and priorities for follow-on, in-depth analysis. CATs may use a wide variety of detailed checklists or formats during a deliberate assessment to ensure they have scrutinized all aspects of the assessment area.

SURVEYS

4-52. The survey is a detailed assessment in which the object of the assessment is examined carefully, as during an inspection or investigation. Surveys are conducted in a methodical manner in accordance with CAO priorities and specific civil information requirements identified during deliberate assessments. This investigation may include people, groups, locations, facilities, or capabilities within a location or part of a critical geopolitical, cultural, or ethnic system. During the survey, the CAT may use a variety of detailed checklists or formats to ensure it has scrutinized all aspects of the specified entity, location, or facility targeted for survey. Survey development should leverage operations or research analysis capabilities, if available. The findings of a survey may lead to refined mission statements or reallocation of forces and resources.

RUNNING ESTIMATE

4-53. ADP 5-0 describes how running estimates provide information, conclusions, and recommendations from the perspective of each staff section. Running estimates help to refine the common operational picture and supplement it with information not readily displayed. Staffs evaluate and synthesize information and provide it to commanders in the form of running estimates to help commanders build and maintain their situational understanding. Upon receipt or in anticipation of a mission, each staff section begins updating its estimate based on information requirements related to the mission. CA forces record relevant civil information in running estimates. They maintain a continuous assessment of the civil component as related to current operations as a basis to determine if they are proceeding according to the mission, commander's intent, and common operational picture.

4-54. The CAO running estimate feeds directly into the MDMP—whether conducted unilaterally as part of CA-only operations, or integrated into the supported unit's planning process and development of the common operational picture through CKI. To focus the estimate process, planners first develop a restated mission statement that delineates those CAO tasks necessary to successfully support the commander's mission. The mission statement is a short sentence or paragraph describing the CAO essential task (or tasks) and purpose of the unit that clearly indicate the action to be taken and the reason for doing so. It contains the elements of who, what, when, where, and why, as well as the reason thereof, but seldom specifies how. Figure 4-2, shows the crosswalk of the MDMP steps with the information in the CAO running estimate.

4-55. During course of action analysis, CAO staff ensure each course of action effectively integrates civil considerations (the C of METT-TC) and present a summary of their running estimate to describe how their findings impact or are impacted by other staff functions. The CAO staff must be able to articulate how operations affect civilians and estimate the requirements for essential stability operations related to the mission. Ultimately, the CAO staff recommends the most effective way to integrate CA, host-nation, and interorganizational capabilities into combined arms operations to support unified land operations.

- 4-56. CAO planners and staff use the running estimate throughout the operations process to—
- Provide the civil situation portion of operations orders and course of action wargaming
 - Maintain awareness of the changing situation.
 - Determine if the current operation is proceeding according to the commander’s intent.
 - Develop branches and sequels to current operations.
 - Determine resource requirements for future operations.

Step in MDMP	CAO Running Estimates
Step 1 Receipt of Mission	Preparation and commencement of recording information.
Step 2 Mission Analysis	Paragraphs 1 and 2, Mission or Situations and Considerations, such as— <ul style="list-style-type: none"> ● CAO concept of support. ● Enemy forces. ● Friendly forces. ● Assumptions. ● METT-TC/ASCOPE.
Step 3 Course of Action Development	Paragraph 3, Course of Action Development.
Step 4 Course of Action Analysis	Paragraph 4, Course of Action Analysis including— <ul style="list-style-type: none"> ● CAO in course of action 1. <ul style="list-style-type: none"> ▪ CAO concept of support. ▪ CAO goals and objectives. ▪ Analysis. ▪ Risk analysis. ● CAO in course of action 2, and so on...
Step 5 Course of Action Comparison	Paragraph 5, Course of Action Comparison.
Step 6 Course of Action Approval	Paragraph 6, Recommendations and Conclusions.
Step 7 Production, Dissemination, and Transition of Orders	Update of running estimate to reflect approved course of action information.
Legend: ASCOPE areas, structures, capabilities, organizations, people, and events CAO Civil Affairs operations MDMP military decisionmaking process METT-TC mission, enemy, terrain and weather, troops and support available-time available and civil considerations	

Figure 4-2. Military decision-making process—running estimate sync chart

ANNEXES

4-57. FM 6-0 describes how staffs support the commander in understanding, visualizing, and describing the OE; making and articulating decisions; and directing, leading, and assessing military operations. Staffs make recommendations and prepare plans and orders for the commander. Staffs use annexes as attachments to plans and orders to provide more detail and organize information. The CAO staff supports the commander in communicating the commander's decisions and intent through these products. Key information recorded in the running estimate informs the orders process—particularly in the functional annexes.

4-58. The CAO staff (G-9 or S-9) refines the CAO aspects of the plan and order by publishing Annex K, further amplifying the commander's intent in terms of CAO. In addition to Annex K, the CAO staff is involved in the development of Annex V (Interagency Coordination), in conjunction with the G-3 or the S-3 and operations staff. In addition, the CAO staff must take great interest in Annex P (Host-Nation Support).

ANNEX K, CIVIL AFFAIRS OPERATIONS, PUBLISHED BY G-9 OR S-9

4-59. Commanders and staffs use Annex K to describe how CAO—integrated with other military and civil organizations—support the CONOPS described in the base plan or order. This annex follows the five-paragraph attachment format. Annex K can have an unspecified number of Appendixes, but it typically has at least the following three:

- Appendix 1—Execution Matrix.
- Appendix 2—Populace and Resources Control Plan.
- Appendix 3—Civil Information Collection Plan.

Note: The base format for Annex K is found in FM 6-0.

ANNEX P, HOST-NATION SUPPORT, PUBLISHED BY G-4 OR S-4

4-60. Annex P uses the five-paragraph attachment format. Commanders and staffs use Annex P to describe how sustainment operations support the CONOPS described in the base plan or order.

4-61. The G-4 or S-4 is the staff officer responsible for Annex P. Host-nation support is the civil and military assistance provided by the HN to the forces located in or transiting through that HN's territory. Efficient use of available host-nation support greatly aids forces and augments the deployed sustainment structure. Much of any host-nation support will be derived through a bilateral, multilateral, or other international agreement. International agreements are with the entirety of the host-nation population and thus have an impact on the IPI. These international agreements will often call for additional acquisition and cross support agreements. U.S. forces obtain local resources to support operations from these agreements. The CMOC is usually in the best position to engage with the civil component on behalf of the G-4 or S-4 for utilization of local resources. Such resources may include water, energy, food, ports, roads, and other resources to sustain the force.

Note: FM 6-0 provides an example of the format for Annex P.

ANNEX V, INTERAGENCY COORDINATION, PUBLISHED BY G-3 OR S-3 AND G-9 OR S-9

4-62. Annex V follows the five-paragraph attachment format; however, some subparagraphs are modified to accommodate communication with the interagency. This annex is important to CA forces because it identifies the interagency organization, military forces, and other entities within the AO and it designates the CA capability that is assigned to integrate CMO through the execution of CMI. This annex clarifies roles, responsibilities and actions that all involved must take to effect critical CMI in the AO and promote unity of effort.

4-63. The G-3 or S-3, in conjunction with the G-9 or S-9, develops Annex V. Annex V provides military and interagency personnel with detailed information (such as mission, scheme, and tasks) to direct the necessary coordination and interaction between Army forces and interagency organizations. It describes how the commander intends to cooperate, provide support, and receive support from interagency partners throughout

the operation. The G-9 or S-9 is the primary staff entity for contact with the interagency and other entities within the civil component for civil-military matters.

4-64. Interagency partners may require the establishment of coordination mechanisms. These coordination mechanisms must be addressed in Annex V. They may include exchanges of liaison officers. They may also include the establishment of a CMOC, humanitarian assistance coordination center, humanitarian operations center, joint interagency task force, joint interagency coordination group, or other interagency coordination entities.

Note: The format for Annex V is found in FM 6-0. JP 3-08 provides additional information on interagency coordination.

CIVIL AFFAIRS ROLE IN MISSION COMMAND

4-65. Mission command is the Army's approach to command and control that empowers subordinate decision making and decentralized execution appropriate to the situation. Mission command supports the Army's operational concept of unified land operations and its emphasis on seizing, retaining, and exploiting the initiative. Mission command is a principle of unified land operations that enables commanders to blend the art of command and the science of control while integrating, coordinating, and synchronizing the warfighting functions during operations.

4-66. Commanders understand that they do not operate independently, but as part of a larger force united by a common operational purpose. They integrate, coordinate, and synchronize their actions with the rest of the force to achieve the overall objective of the operation. CA forces enable the commander to extend mission command influence beyond military forces and into the civil networks, organizations, and institutions that the commander does not have command and control over. These civil networks are built and integrated into operations through CNDE, and partnerships are managed through CMI. Integration, coordination, and synchronization between military forces and civilian elements is crucial to mission success and achieving unity of effort.

4-67. Commanders create and sustain situational understanding through collaborative dialogue within their organization (and with unified action partners) to facilitate unity of effort. Commanders provide a clear intent and use mission orders to assign tasks, allocate resources, and issue broad guidance. CAO staff develop and identify civil information collection requirements through CNDE, CKI, and CMI. The collected civil data and information is analyzed and evaluated to produce actionable civil knowledge. In CKI this civil knowledge is integrated into Army operations systems and updates running estimates enabling the commander to visualize the civil component, and increasing the commander's situational understanding of the OE.

CIVIL AFFAIRS ROLE IN THE WARFIGHTING FUNCTIONS

4-68. CA has several roles in the warfighting functions, which are displayed in figure 4-3, page 4-18, and detailed in the following paragraphs.

	Command and Control	Intel	Movement and Maneuver	Fires	Protection	Sustainment
Theater Army ++ CA	<ul style="list-style-type: none"> Theater-level civil network development. Integrate inter-organizational partners and civil considerations into Theater Campaign Plans and synchronize with Integrated Country Strategies (ICS). Policy development for Transitional Governance in theater. Civil-knowledge integration to national and theater strategic common operational picture. 	<ul style="list-style-type: none"> Integrate forward presence CA information collection with theater intel assessments. Participate in development of messages and supporting activities to influence behavior of friends and adversaries. 	<ul style="list-style-type: none"> Ensuring Maneuver has freedom of action through mitigation of civilian interference to operations. 	<ul style="list-style-type: none"> Preparation of Theater Restricted Target Lists with national and theater strategic partners. 	<ul style="list-style-type: none"> Security Force Assistance to Partner Nation paramilitary forces, law enforcement and CA/CIMIC forces according to Integrated Country Strategies. Theater Disaster Response (e.g., TF Ebola). 	<ul style="list-style-type: none"> Support to theater-level APOD and SPOD agreements. Identification of/ coordination with sources of commercial and host government facilities, labor, services, and sustainment items for military use across theater. Coordinate international donor support of Class X to alleviate strain on military resources for sustainment of civilian populations.
Field Army x CA	<ul style="list-style-type: none"> Plan/oversee CA support to Irregular Warfare. Plan/oversee Transitional Governance (Transitional Military Authority/Support to Civil Administration). Civil-knowledge integration to operational common operational picture. Participate in development of messages and supporting activities to influence behavior of friends and adversaries. 	<ul style="list-style-type: none"> Forward Presence Operations (Preparation of Environment). Information collection and sharing with Intel to develop situational understanding. 	<ul style="list-style-type: none"> Enable Reception, Staging, Onward movement, and Integration ICW HN Law Enforcement/ Security Forces for: <ul style="list-style-type: none"> Populace and Resources Control. Area/Route Security. 	<ul style="list-style-type: none"> Support to Precision Fires/ Targeting. Maintain and update Restricted Target Lists. In competition, target adversary diplomatic, economic, information capabilities, institutions. In LSCO, separate enemy from population's resources and capabilities. Track and analyze civilian casualties and battle damage to critical infrastructure and cultural properties. 	<ul style="list-style-type: none"> Execute Irregular Warfare/Support to Protection to mitigate conditions that could lead to crisis. Continuous Civil Network Development/ Expansion. Counter-enemy special purpose forces. Transitional Public Security. Populace and Resources Control, including dislocated civilian operations. 	<ul style="list-style-type: none"> Identification of/ coordination with sources of commercial and host government facilities, labor, services, and sustainment items for military use across corps and below areas of operation. Coordinate delivery of international donor Class X items in corps and below areas of operation to alleviate strain on military resources for sustainment of civilian populations.
Corps x CA	<ul style="list-style-type: none"> Identify civil centers of gravity in corps and below area of operations. Plan and coordinate branches and sequels to current and future operations. Integrate inter-organizational partners and civil considerations into Corps and below plans and activities. Execute Transitional Governance (Transitional Military Authority/Support to Civil Administration) and civil sector capability development (e.g., resistance, resilience). Civil-knowledge integration to operational and tactical common operational picture. 	<ul style="list-style-type: none"> Conduct operational and tactical civil reconnaissance and civil engagement. Analyze changing human geography to inform and update commander's decision matrix. 	<ul style="list-style-type: none"> Execute Irregular Warfare/ Network Utilization/ Stabilization-Destabilization in corps and division consolidation areas to— <ul style="list-style-type: none"> Facilitate freedom of maneuver. Maintain operating tempo. Preserve combat power. By, with, and through partners to— <ul style="list-style-type: none"> Establish civil security. Establish civil control. Restore essential services. Support governance. Support economic development. Conduct security cooperation. 	<ul style="list-style-type: none"> Execute Irregular Warfare/Support to Protection to mitigate conditions that could lead to crisis. In LSCO, separate enemy from population's resources and capabilities. Track and analyze civilian casualties and battle damage to critical infrastructure and cultural properties. 	<ul style="list-style-type: none"> Execute Irregular Warfare/Support to Protection to mitigate conditions that could lead to crisis. Continuous Civil Network Development/ Expansion. Counter-enemy special purpose forces. Transitional Public Security. Populace and Resources Control, including dislocated civilian operations. 	<ul style="list-style-type: none"> Identification of/ coordination with sources of commercial and host government facilities, labor, services, and sustainment items for military use across corps and below areas of operation. Coordinate delivery of international donor Class X items in corps and below areas of operation to alleviate strain on military resources for sustainment of civilian populations.
Division II CA	<ul style="list-style-type: none"> Execute operational CA activities that shape perceptions and influence behavior of friends and adversaries. Civil-knowledge integration to tactical common operational picture. Execute tactical CA activities that shape perceptions and influence behavior of friends and adversaries. 					

Legend:

APOD	aerial port of debarkation	Class X	material to support nonmilitary programs such as agriculture and economic development	ICW	in coordination with
CA	Civil Affairs	HN	host nation	LSCO	large scale combat operations
CIMIC	civil-military cooperation			SPOD	seaport of debarkation
				TF	task force

Figure 4-3. Civil Affairs in the warfighting functions

COMMAND AND CONTROL

4-69. *Command and control* is the exercise of authority and direction by a properly designated commander over assigned and attached forces in the accomplishment of mission (JP 1). The command and control

warfighting function tasks focus on integrating the activities of the other elements of combat power to accomplish missions. Commanders, assisted by their staffs, integrate numerous processes and activities within their headquarters and across the force through the command and control warfighting function. These tasks are—

- Command forces.
- Control operations.
- Drive the operations process.
- Establish the command and control system.

4-70. CA forces provide the commander with increased command and control by providing an improved situational awareness through CKI, enabling unity of effort through CMI, and providing expertise in governance when conducting TG. Civil networks built and integrated into operations during all phases of the competition continuum provide commanders with a wealth of information regarding the civil component of the OE. CNDE provides access to information sources, resources, and the ability to produce desired effects in areas where U.S. forces may have no physical presence. CNDE and CMI also provide the commander the ability to extend command influence across the operational area and into areas of interest.

4-71. In the consolidation and support areas, CNDE provides access to resources, information, and data that leads to better plans for SCA or transitional military authority. Identification of civil governance resources, capabilities, and critical infrastructure enable civil security and civil control requirements. The enhanced understanding and knowledge promote decisions that lead to more accurate and precise operations in support of offensive, defensive, or stability actions needed at other locations within the AO. In the close and deep areas, civil networks developed by CA forces provide valuable civil information and data regarding the conditions that await U.S. forces beyond the forward line of own troops. This information also allows staffs to prepare for the consolidation operations, identification of critical infrastructure, and resources that are needed as the bulk of the U.S. offensive moves forward.

4-72. Through CNA, civil information is used to produce relevant and current civil knowledge. CKI is accomplished through CAO staff to integrate the resulting civil knowledge into the commander's decision-making process to increase the effectiveness of command and control at all echelons and to gain the information advantage.

CIVIL AFFAIRS INTEGRATION INTO INFORMATION OPERATIONS

4-73. The role of CAO as an information-related capability is multifaceted. CAO is integrated with other information-related capabilities into the IO plan of the commander to provide the tangible actions or events needed for the commander to translate a message through the physical dimension of the information environment. In this way, CAO act as the tangible connection for the commander to be able to influence the cognitive dimension and produce desired effects in the civil component.

4-74. Assessments of atmospherics through CE and changes in behavior spotted through patterned CR also allow for commanders to understand the effects of IO plans and actions. When the IO effort of the commander necessitates an attack orientation, CA forces integrate mobilized civil networks into operations to increase civil security and civil control, thereby impairing threat networks and degrading popular support for threat elements. In stabilization, CAO is most often synchronized with combat camera, PSYOP, public affairs, and foreign disclosure to align actions with messages and themes to create support for rule of law, local security forces, and legitimate authority.

4-75. Through the IO working group, the CAO staff provides advice and support with the following information:

- Specific country information.
- Timely update of the civil component of the common operational picture through the CKI process.
- Civil considerations within the OE.
- Concerns of population groups within the projected joint operations area or AO and potential flash points that might result in civil instability.
- Cultural awareness briefings.

- Information on DC movement routes; critical infrastructure; and significant social, religious, and cultural shrines, monuments, and facilities.
- Information impacts on the civil component.
- Key civilian nodes.
- Review of lethal fires packets to ensure that lethal and nonlethal effects of targeting are synchronized.

MOVEMENT AND MANEUVER

4-76. The *movement and maneuver warfighting function* is the related tasks and systems that move and employ forces to achieve a position of relative advantage over the enemy and other threats (ADP 3-0). The movement and maneuver warfighting function includes tasks associated with force projection. Movement is necessary to disperse and displace the force as a whole, or in part, when maneuvering. Commanders use maneuver for massing effects to achieve surprise, shock, and momentum. Effective maneuver requires close coordination of fires and movement. Both tactical and operational maneuver require sustainment support. The movement and maneuver warfighting function includes these tasks:

- Move.
- Maneuver.
- Employ direct fires.
- Occupy an area.

4-77. On the modern battlefield, almost all movement and maneuver take place amongst the civilian population and with the use of civilian infrastructure. Populace and civil infrastructure are force multipliers when developing plans which utilize timely and accurate information. However, without proper planning and preparation, those civilians and infrastructure become a great hindrance to effective movement and maneuver.

4-78. CAO enables movement and maneuver through identification and utilization of civilian infrastructure, networks and systems, and reduction of civilian interference. Integration of civil networks and partnership with civil authorities also enables the commander to establish movement and maneuver corridors which are cleared of civilians to the greatest extent possible. This allows for the use of alternatives for security such as—

- Use of local security for lines of communication and maneuver corridors.
- Enablement of freedom of movement.
- Efficient use of finite resources and capabilities.

4-79. In the planning process, CKI is utilized to provide commanders and staffs with the civil knowledge needed to ensure that all movement and maneuver is planned to avoid or mitigate civilian interference with operations. Planners also use this civil knowledge to mitigate the effects of military operations on the civilian population and infrastructure. Civil information and data gained through CR, CE, CND, area studies, and initial and deliberate assessments provide commanders and staffs with an understanding of—

- Civilian choke points.
- Areas where U.S. movements are more likely to be opposed by the population.
- Areas where movement and maneuver will not be hindered by civilian interference.

4-80. During offensive operations, civil networks that have been identified, developed, and integrated into operations by CA forces perform functions of governance and PRC measures to ensure civilian interference with military movement is greatly reduced. Proper utilization of PRC in consolidation and support areas mitigates the need for commanders to dispatch troops to control these areas, thereby preserving combat power and effectively using finite resources. Effective use of PRC in consolidation areas increases the freedom of movement between consolidation areas and close areas. This allows commanders to—

- Maintain the initiative and extend their culmination point at the forward line of troops.
- Enable joint reception, staging, onward movement, and integration.
- Allocate military resources when and where they are needed.

4-81. During defensive and stability operations, civil networks that CA forces have identified, developed, and integrated into operations to aid PRC (in consolidation and rear areas) enable commanders to move

troops and materiel around the battlefield in a more efficient and timely manner, thereby maintaining operating tempo. This frees military resources the commander needs to continue the offense in other areas.

INTELLIGENCE

4-82. The *intelligence warfighting function* is the related tasks and systems that facilitate understanding the enemy, terrain, weather, civil considerations, and other significant aspects of the operational environment (ADP 3-0). Other significant aspects of an OE include threats, adversaries, and operational variables, which vary with the nature of operations. The intelligence warfighting function synchronizes information collection with the primary tactical tasks of reconnaissance, surveillance, security, and intelligence operations. Intelligence is driven by commanders, and it involves analyzing information from all sources and conducting operations to develop the situation. The Army executes intelligence, surveillance, and reconnaissance through operations and intelligence processes, with an emphasis on intelligence analysis and information collection. The intelligence warfighting function includes these tasks:

- Provide intelligence support to force generation.
- Provide support to situational understanding.
- Conduct information collection.
- Provide intelligence support to targeting and IO.

4-83. Interaction with civil networks across the operational area and area of interest provides commanders with a greater understanding of societal factors and allows staffs to create a more detailed map of the interactions of friendly and threat actors in the OE. Friendly civil networks provide the commander an exponentially larger platform for surveillance and reconnaissance than would otherwise be available. Engagement with civil networks also provides the commander with access to civil information coming from areas where the commander might not have physical or virtual presence. This understanding empowers commanders with the ability to plan and execute greater and more effective operations actions against threat activities. Greater situational understanding of culture and civil considerations also identifies the risks to U.S. forces and the overall military campaign in the civil component of the OE, thereby ensuring the commander is able to make more timely and informed decisions.

FIRES

4-84. The *fires warfighting function* is the related tasks and systems that create and converge effects in all domains against the adversary or enemy to enable operations across the range of military operations (ADP 3-0). These tasks and systems create lethal and nonlethal effects delivered from both Army and joint forces, as well as other unified action partners. CA forces typically provide effects in the nonlethal realm but also use civil knowledge to enhance considerations for the use of lethal actions. Targeting is a function of fires and is greatly enhanced by the integration of civil knowledge.

4-85. Civil information gained through CR, CE, CND, area studies, and other methods is analyzed and evaluated and the resulting civil knowledge is integrated into the commander's targeting process. To enhance targeting the CAO staff provide—

- Options for engagement and effects utilizing CA forces.
- Identified, developed, and integrated civil networks.
- Validate survey control points.
- Enhanced governance capability.
- Services and recommendations for PRC that protect—
 - Civilians.
 - Critical infrastructure.
 - Resources.
 - Other noncombatants.

4-86. In consolidation and support areas, CNDE and CMI provide the commander with courses of action to create effects in the civil component of the OE which support the commander's lines of effort, mission, and end states. Partner civil networks provide early identification of threats and adversarial actors which might pose a

threat to local security and military missions. Mobilization of those same networks to enhance governance also provides the commander an option for neutralizing threat actors locally with minimal resources and damage.

4-87. In close and deep areas, partner civil networks help identify threats and adversaries in the civil component of the OE which might not be readily visible to military intelligence processes. Partner civil networks provide commanders with options to neutralize those threats through local governance action, and to identify and categorize civilian entities and infrastructure which must be protected from the effects of war to the greatest extent practicable. Information gained through civil networks also helps to fill in gaps in the targeting process, which enable the targeting staff to provide more accurate and effective targeting to meet the operational needs of the commander.

4-88. During targeting the staff has the responsibility to mitigate the unintended or incidental risk of damage or injury to the—

- Civilian populace and noncombatants.
- Military personnel.
- Structures and cultural heritage sites in the immediate area.
- Targets that are on the—
 - No-strike list.
 - Restricted target list.
- Livestock.
- Environment.
- Civil air.
- Other factors that could have a negative effect on military operations.

4-89. This will assist the commander in weighing risk against military necessity and in assessing proportionality within the framework of the MDMP. CA forces identify civilian entities and infrastructure that should be protected and placed on a no strike list or should be protected with restricted fire. The commander may issue targeting guidance that constrains and restrains the use of fires by identifying no-strike or restricted target lists. The no-strike list consists of objects or entities protected by:

- Law of war.
- International laws.
- Rules of engagement.
- Other considerations.

4-90. A restricted target list is a valid target with specific restrictions such as:

- Limit collateral damage.
- Preserve select ammo for final protective fires.
- Do not strike during daytime.
- Strike only with a certain weapon.
- Proximity to protected facilities and locations.

SUSTAINMENT

4-91. The *sustainment warfighting function* is the related tasks and systems that provide support and services to ensure freedom of action, extended operational reach, and prolong endurance (ADP 3-0). Sustainment determines the depth and duration of Army operations. Successful sustainment enables freedom of action by increasing the number of options available to the commander. Sustainment is essential for retaining and exploiting the initiative. The sustainment warfighting function consists of four elements:

- Logistics.
- Financial management.
- Personnel services.
- Health service support.

4-92. CA forces provide commanders, at all echelons, options for enhancing reception, staging, onward movement and integration, and for utilizing civilian support channels for provision of military needs. Persistent

or episodic engagement with civil networks, and development of partner capacity through security cooperation missions allows commanders access to civil information that is critical in planning initial entry and staging operations. Those same partner civil networks can be utilized to identify and provide civilian resources which can be allocated for military use and for the creation of partnerships with local governments for the purpose of enhancing host-nation support that has been negotiated between the U.S. and the HN.

4-93. Sourcing requirements locally reduces the logistical burden on commanders and allows for greater conservation of resources which are hard to acquire, but necessary for prosecuting the fight against the enemy. Local resources also shorten the logistic lines, which slow a force's movement. *Host-nation support* is civil and/or military assistance rendered by a nation to foreign forces within its territory during peacetime, crises or emergencies, or war based on agreements mutually concluded between nations (JP 4-0).

4-94. CA forces in the consolidation and support areas partner with local governments and organizations through CNDE and CMI to ensure that there is no disruption to logistics supply from adversaries in the civil component. Logistics convoys, especially those contracted locally during operational preparation of the environment and stability operations, are ripe for exploitation from criminal elements. CA forces partnered with local civil networks and governments help identify and disrupt criminal enterprises that may be associated with enemy elements. This action benefits the security of logistics supplies into the close area. Greater civil security in the rear area frees military resources that the commander needs to push to the forward line of own troops. It also allows for more reliable logistics chains supporting elements on the offensive.

4-95. During stabilization operations, CA forces and planners are critical in identifying humanitarian needs and working with local sources and international partners to provide for the humanitarian needs of the population. Partnerships built through CNDE and executed through CMI ensure that local governance elements always provide a local face for the diminution of humanitarian distress. These actions help to build legitimacy of the HN.

PROTECTION

4-96. The *protection warfighting function* is the related tasks and systems that preserve the force so the commander can apply maximum combat power to accomplish the mission (ADP 3-0). Commanders incorporate protection when they understand and visualize threats and hazards in an OE. This allows them to synchronize and integrate all protection capabilities to safeguard bases, secure routes, and protect forces.

4-97. Preserving the force includes protecting the following assets of the U.S., unified action partners, and HNs:

- Personnel (combatants and noncombatants).
- Physical assets.

4-98. Protection determines the degree to which potential threats can disrupt operations so that forces may counter or mitigate those threats before they can act. However, protection is not a linear activity—planning, preparing, executing, and assessing protection are continuous and enduring activities. The protection warfighting function includes these tasks:

- Conduct survivability operations.
- Conduct support to SCA.
- Integrate civil knowledge in the development of security control, area security, and civil security plans.
- Execute CNDE to inform the common operational picture.
- Develop civil networks to identify capabilities, capacities, and resources that can be used to secure and protect the force.
- Provide force health protection.
- Conduct chemical, biological, radiological, and nuclear operations.
- Provide explosive ordnance disposal support.
- Coordinate air and missile defense support.
- Conduct personnel recovery.
- Conduct detention operations.
- Conduct RM.
- Implement physical security procedures.

- Apply antiterrorism measures.
- Conduct police operations.
- Conduct PRC.
- Conduct area security.
- Perform cyberspace security and defense.
- Conduct electromagnetic protection.
- Implement operations security.

4-99. Civil knowledge is integrated into the RM process of the supported commander, thereby empowering the commander and associated staff with a greater situational understanding of risks and hazards that might be present in the civil component of the OE across the competition continuum and emanating from multiple domains. CAO staff, in coordination with the protection cell, also develop and recommend controls that reduce risk to the population and reduce risk to U.S. forces from threats and hazards emerging from civilian society. These types of risks and hazards to U.S. and partner forces take the form of local demonstrations, criminal enterprises, ineffective PRC, and lack of civil security and civil control. Each of these are issues that are ameliorated through effective local governance. CA forces support protection by identifying risks in the civil component and partnering with local civil networks to mitigate those risks and protect civil assets through effective governance.

4-100. In consolidation and support areas, CA forces—in conjunction with other capabilities—may be called upon to identify and implement PRC measures. CA forces utilize partner civil networks, through CNDE and CMI, to enhance local governance capability and identify critical infrastructure and resources to increase civil security and civil control. These actions aid in the implementation of PRC measures while simultaneously freeing combat power for more tactical operations.

4-101. In close and deep areas, civil networks provide information leading to early identification of threats and hazards of which the commander may not otherwise be aware. This allows the commander and staff to adjust plans as the offensive continues to push the forward line of own troops. Friendly civil networks can also be integrated into operations to conduct protection and security efforts in support of the commander's end state.

CIVIL AFFAIRS CAPABILITY BY ECHELON

4-102. The CA workload rule of allocation provides a method to analyze non-echelon aligned allocation of CA force requirements. CA planners should understand this is the basis for employment, but not the only model. There is also a workload model and a workload command and control model. The CAO staff officer is responsible for providing recommendations to the commander on the allocation of CA forces to the appropriate headquarters. The CAO staff officer advises on the capabilities, capacity, allocation, and employment of subordinate CA units attached to the command.

4-103. The CA company is the lowest level unit allocated by rules of allocation. CATs are not allocated to Army forces through rules of allocation, but CATs—based on the mission requirements—may be attached from the company down to subordinate elements of the BCT.

4-104. CA companies and battalions are most commonly allocated as direct support elements for a specific command, but can serve a general support function (depending on the AO and the security of the environment). CA brigades and CACOMs are most effectively allocated as general support elements for a specific AO.

4-105. CA planners should understand that figure 4-3, page 4-18, shows the baseline rules of allocation for CA employment, but this is not the only model. Urbanization trends will continue to challenge the proper allocation of CA units to ensure mission success. Larger urban areas may require a more robust allocation of CA forces per BCT or to adequately identify and mitigate or defeat threats to civil society. Furthermore, not all operations will be conducted in conjunction with a BCT.

4-106. Figure 4-4 (which continues on page 4-26) depicts CA unit's functions, operational scope and coordination, from the strategic down to the tactical level. Functions at each level correspond to activities from planning to execution. The operational scope represents the approximate operational area, and the coordination depicts key organizations that interact with CA forces.

4-107. The nature of the mission may require more CA assets. For example, advising on or conducting the responsibilities normally performed by a civil government will likely require more CA augmentation to succeed. The workload rule of allocation shown in figure 4-5, page 4-27, was designed to account for these variables. Using the metrics provided at the bottom of figure 4-5 helps create an accurate assessment of CA force requirements based on population of an area in square miles or based on a population within a specific population center.

Level of Support (Name)	Unit	Focus of Functions	Operational Scope	Coordination
Strategic (Geographic Combatant Command, Theater Army)	CACOM	<ul style="list-style-type: none"> Plan, assess, and manage theater CAO. Plan, assess, and manage TG. Facilitate and enable information advantage. Support stabilization, reconstruction, and development. Enable IPI, interagency, and interorganizational coordination. Identify requirements for functional specialist assistance. 	Regional to National	<ul style="list-style-type: none"> U.S. embassy. USAID or interagency. International partners or donors. International organizations or NGOs. IPI.
	Theater CAPT	<ul style="list-style-type: none"> Plan, assess, and manage theater CAO. Plan, assess, and manage TG (national). Facilitate and enable information advantage. Support stabilization, reconstruction, and development. Enable IPI, interagency, and interorganizational coordination. 	Regional to National	<ul style="list-style-type: none"> U.S. embassy. USAID or interagency. International partners or donors. International organizations or NGOs. IPI.
Operational (Corps, JTF, 1st Special Forces Command)	CA Brigade	<ul style="list-style-type: none"> Plan, assess, and manage CAO. Plan, assess, and manage TG (subnational). Facilitate and enable information advantage. Support stabilization, reconstruction, and development. Enable IPI, interagency, and interorganizational coordination. 	National to Subnational	<ul style="list-style-type: none"> U.S. embassy. USAID (OFDA and OTI). Interagency. International organizations or NGOs. IPI.

Figure 4-4. Civil Affairs allocations and support functions

Level of Support (Name)	Unit	Focus of Functions	Operational Scope	Coordination																																																
Operational to Tactical (Division, JTFs, TSOCs JSOTF)	CA Battalion	<ul style="list-style-type: none"> Plan, assess, and execute CAO. Plan, assess, stability activities. Facilitate and enable information advantage. Enable IPI, interagency, and interorganizational coordination. 	Subnational to Province or Large City	<ul style="list-style-type: none"> U.S. embassy. USAID (OFDA and OTI). Interagency. International organizations or NGOs. IPI. 																																																
Tactical (BCT, JTF, COM, Special Forces Battalions, Regional CMSE)	CA Company	<ul style="list-style-type: none"> Plan, assess, and manage CAO (execution oriented) such as— <ul style="list-style-type: none"> CR, CE, CKI, CMOC. Foreign assistance, FHA, PRC, CMI. Plan, assess, and enable local stability activities. Facilitate and enable information advantage. Enable IPI and interagency coordination. 	Province to Large City	<ul style="list-style-type: none"> OFDA. Interagency. International organizations or NGOs. IPI. 																																																
<p>Note: Operational Scope and Level of support for CA echelons can vary widely based on operational need</p> <p>Legend:</p> <table> <tbody> <tr> <td>BCT</td> <td>brigade combat team</td> <td>FHA</td> <td>foreign humanitarian assistance</td> </tr> <tr> <td>CA</td> <td>Civil Affairs</td> <td>IPI</td> <td>indigenous populations and institutions</td> </tr> <tr> <td>CACOM</td> <td>Civil Affairs command</td> <td>JSOTF</td> <td>joint special operations task force</td> </tr> <tr> <td>CAO</td> <td>Civil Affairs operations</td> <td>JTF</td> <td>joint task force</td> </tr> <tr> <td>CAPT</td> <td>Civil Affairs planning team</td> <td>NGO</td> <td>nongovernmental organization</td> </tr> <tr> <td>CE</td> <td>civil engagement</td> <td>OFDA</td> <td>Office of United States Foreign Disaster Assistance</td> </tr> <tr> <td>CKI</td> <td>civil knowledge integration</td> <td>OTI</td> <td>Office of Transition Initiatives</td> </tr> <tr> <td>CMI</td> <td>civil-military integration</td> <td>PRC</td> <td>populace and resources control</td> </tr> <tr> <td>CMOC</td> <td>civil-military operations center</td> <td>TG</td> <td>transitional governance</td> </tr> <tr> <td>CMSE</td> <td>civil-military support element</td> <td>TSOC</td> <td>theater special operations command</td> </tr> <tr> <td>COM</td> <td>collection operations management</td> <td>U.S.</td> <td>United States</td> </tr> <tr> <td>CR</td> <td>civil reconnaissance</td> <td>USAID</td> <td>United States Agency for International Development</td> </tr> </tbody> </table>					BCT	brigade combat team	FHA	foreign humanitarian assistance	CA	Civil Affairs	IPI	indigenous populations and institutions	CACOM	Civil Affairs command	JSOTF	joint special operations task force	CAO	Civil Affairs operations	JTF	joint task force	CAPT	Civil Affairs planning team	NGO	nongovernmental organization	CE	civil engagement	OFDA	Office of United States Foreign Disaster Assistance	CKI	civil knowledge integration	OTI	Office of Transition Initiatives	CMI	civil-military integration	PRC	populace and resources control	CMOC	civil-military operations center	TG	transitional governance	CMSE	civil-military support element	TSOC	theater special operations command	COM	collection operations management	U.S.	United States	CR	civil reconnaissance	USAID	United States Agency for International Development
BCT	brigade combat team	FHA	foreign humanitarian assistance																																																	
CA	Civil Affairs	IPI	indigenous populations and institutions																																																	
CACOM	Civil Affairs command	JSOTF	joint special operations task force																																																	
CAO	Civil Affairs operations	JTF	joint task force																																																	
CAPT	Civil Affairs planning team	NGO	nongovernmental organization																																																	
CE	civil engagement	OFDA	Office of United States Foreign Disaster Assistance																																																	
CKI	civil knowledge integration	OTI	Office of Transition Initiatives																																																	
CMI	civil-military integration	PRC	populace and resources control																																																	
CMOC	civil-military operations center	TG	transitional governance																																																	
CMSE	civil-military support element	TSOC	theater special operations command																																																	
COM	collection operations management	U.S.	United States																																																	
CR	civil reconnaissance	USAID	United States Agency for International Development																																																	

Figure 4-4. Civil Affairs allocations and support functions (continued)

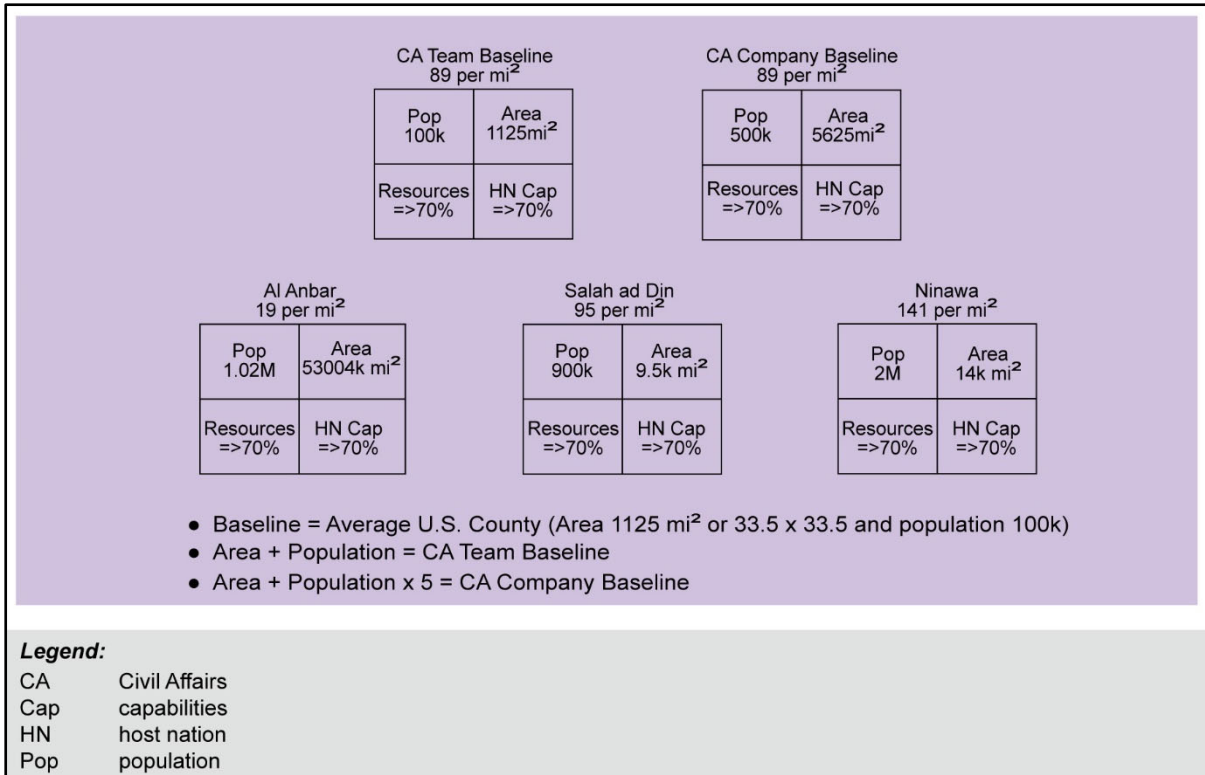


Figure 4-5. Civil Affairs workload rule of allocation

CIVIL AFFAIRS TEAM

4-108. The CAT conducts CAO missions at the tactical level. Teams have the ability to conduct CR and CE and to establish connections with and mobilize civil networks. The CAT is also the element that can produce desired effects in the civil component by—

- Working with and through civil networks.
- Conducting CA projects and programs.
- Coordinating and directing humanitarian aid provision and distribution.
- Providing governance expertise and SCA at the local level.
- Conducting other CAO meant to interact directly with civilian populations.

4-109. A limitation of the CAT is its size and need for theater-mandated force protection support. While in competition environments, the CAT has much greater freedom of movement than regular forces due to interactions with the civil population. However, during large-scale combat operations, CATs are generally in need of force protection support as the team is only four members and it is routinely embedded in other maneuver elements to provide for the force protection needs of the team.

4-110. CATs are deployable CA units of action capable of—

- Conducting CR and CE to support strategic-, operational-, and tactical-level civil-military objectives in support of conventional brigade level missions.
- Developing and leveraging civil networks and conducting CMI to find, disrupt, and defeat hybrid threats in the civil component.
- Providing an advantage to the USG, allies, and partners, through the conduct of CR, CE and CMI.

CIVIL AFFAIRS COMPANY

4-111. In large-scale combat operations, the CA company operations section provides the supported commander the capability to analyze, evaluate, and direct CND and engagement in order to create effects in the civil component

of the OE. While CATs are generally placed under the tactical control of maneuver battalion commanders, the CA company headquarters element maintains the ability to develop CAO plans, across BCTs, which are aimed at—

- Developing civil networks to create effects in the civil component of the OE.
- Establishing support to governance aimed at increasing civil security, civil control, and local authority.
- Conducting CMI with local governments, NGOs, and interagency partners.

4-112. While the CA company provides a great asset to the supported commander by increasing analytical capability for understanding the civil component of the OE and adding support to plan and direct CAO, the CA company is not as robust a planning and analysis element as the CA battalion. A CA company has the ability to displace and move rapidly with its supported BCT, but the CA company is in need of certain life support sustainment and force protection.

4-113. Whether as a CA company headquarters supporting a BCT or CAT supporting maneuver battalions, CA company personnel can contribute to and or perform—

- Mission command of assigned or attached CMOC and CATs.
- Tactical-level planning, management, coordination, and synchronization of CAO within the supported commander's AO.
- Assessment of the civil component of the AO of the supported command facilitating integration of civil input into the common operational picture of the supported command.
- Collation, analysis, and fusion of civil information for input to the common operational picture of the supported command.
- Assistance in coordinating IPI, intergovernmental organizations, NGOs, and U.S. assistance and resources to support local government as part of CMO.

4-114. The CA company is a deployable CA command and control node capable of commanding and controlling CATs and operating a CMOC. CA companies conduct CR and CE at the tactical level to support strategic-, operational-, and tactical-level civil-military objectives capable of—

- Developing and leveraging civil networks.
- Conducting CMI to find, disrupt, and defeat hybrid threats in the civil component.
- Providing an advantage for the USG, allies, and partners.
- Being task-organized or augmented to form the core of a joint civil-military operations task force (JCMOTF) led by a major.

CIVIL AFFAIRS BATTALION

4-115. The CA battalion provides all the analytical capacity needed to analyze and evaluate civil network information and civil information products by CA companies within their supported command. This analysis and evaluation is integrated into planning and command and control processes of the supporting command to enable situational understanding and provide for effects in the civil component through targeted CAO.

4-116. The CA battalion provides direct support CA capabilities to missions in geographic combatant command areas of operation. This direct support is provided with emphasis on theater persistent presence activities that—

- Build and employ local, regional, and trans-regional networks.
- Anticipate and exploit changing conditions in human geography.
- Implement conflict prevention strategies.
- Set conditions for successful CAO in support of the requirements for the following:
 - Geographic combatant command.
 - Army Service component command.
 - The USG.

4-117. This support includes the following:

- Planning and coordination of tactical-level stabilization and reconstruction focused on the civil institutions at provincial level and below.
- Tactical-level to operational-level civil components for the supported commander's common operational picture.
- Operation of CMOC away from the supported unit, as required, by serving as the focal point for civil-military coordination collaboration, and communication for the supported unit headquarters.

4-118. When required, the CA battalion also deploys as echelons above brigade- or division-level command and control headquarters for assigned and attached units conducting CAO. The CA battalion can also be task-organized or augmented to form the core of a JCMOTF led by a lieutenant colonel.

CIVIL AFFAIRS BRIGADE

4-119. There are nine reserve component conventional CA brigades and one active component special operations-capable CA brigade. Each has unique capabilities and supports the Army in different conditions.

4-120. The CA brigade is a deployable expeditionary command and control node capable of providing command and control of up to five CA battalions—both assigned and attached units. These CA brigades—

- Provide focused CA capabilities to corps-level, theater Army, and field Army missions and areas of operation.
- Plan, synchronize, and conduct CAO to—
 - Develop, leverage, and exploit regional and trans-regional civil networks.
 - Anticipate and exploit changing conditions in human geography.
 - Set conditions for successful CMO in support of corps objectives.
- Plan, direct, and integrate CNDE to conduct stabilization and irregular warfare across the competition continuum in support of—
 - CCDRs.
 - U.S. Ambassadors.
 - Other agencies (as directed).
- Can be task-organized or augmented to form the core of a JCMOTF led by a colonel.
- Provide crisis response or rapid deployment for natural and manmade disaster responses.

CIVIL AFFAIRS COMMAND

4-121. The U.S. Army has four Civil Affairs commands (CACOMs) in the United States Army Reserve (USAR). Each CACOM is commanded by a brigadier general (known as the theater CA coordinator) who serves as the senior CA military government advisor to—

- Geographic CCDRs.
- Theater army commanders.
- Field army commanders.
- Unified action partners.

4-122. The CACOM is a formation that provides command and control for operational planning, supervision, and coordination of assigned or attached CA units engaged in CA, military government, and stabilization missions across the competition continuum for a theater Army or JTF.

4-123. The CACOM also—

- Provides theater-level CA coordination, policies, and programs in support of stabilization, reconstruction, and development efforts.
- Develops plans, policy, and programs through planning teams, regional engagement, and civil component analysis at both the strategic and theater levels.
- Integrates civil knowledge to inform all operations processes.

4-124. When tasked to form a one-star combined joint integrated CMO task force, the CACOM may also provide command and control over the following assigned or attached military capabilities across the competition continuum:

- Joint or multinational engineer.
- Military police.
- Medical.
- Maneuver.

4-125. The CACOM may also provide command and control to other stability-related, civilian and military capabilities during periods of competition, armed conflict, and return to competition.

CIVIL AFFAIRS TASK FORCE

4-126. A CA task force is a scalable unit in charge of the stabilization elements and organized around the nucleus of CA and support elements. CA task forces are temporarily task-organized formations sourced from Army units and assigned to a theater Army, corps, division, or BCT. When operating during consolidation of gains, CA units establish the core of a CA task force with the commander and staff and their respective subordinate units. A CA task force may be augmented with any of the following elements:

- Public affairs.
- Maneuver elements.
- Engineers.
- Medical units.
- Military police.
- Logistics and transportation elements.
- Other units as necessary for stabilization operations.

4-127. The primary mission of the CA task force is to focus the stabilization efforts in an AO under one command line, thereby increasing the speed and efficiency of stabilization operations tasks. The speed with which transition occurs from U.S. forces to local authorities is dependent on the ability to plan and control elements aimed at increasing governance at the tactical and operational levels. CA task forces provide the important linkage between interagency, interorganizational, and NGOs which are important to the success of stabilization operations. During large-scale combat operations and consolidation of gains, a CA task force can—

- Be a stand-alone task force or subordinate unit to a higher task force.
- Assist unit commanders when their organic ability cannot meet the civil needs of their AO.
- Plan and direct CAO in a supported AO.
- Provide CNA and direction for development and mobilization within an AO.
- Provide linkage between the supported command and nonmilitary agencies operating in the AO through a CMOC.
- Advise the supported commander on policy; funding; multinational, foreign, or host-nation sensitivities; and the effects of these components on theater strategy and/or campaign and operational missions.
- Provide command and control, or direction, of military host-nation advisory, assessment, planning, and other assistance activities by U.S. forces.
- Assist in establishing military-to-civilian links to facilitate cooperative assistance arrangements.
- Perform essential coordination or liaison with host-nation agencies; country teams; United Nations agencies; and deployed U.S., multinational, and host-nation military forces and supporting logistic organizations.
- Assist in the planning and conduct of civil information programs to publicize positive results and objectives of military assistance projects in order to—
 - Build civil acceptance and support of U.S. operations.
 - Promote local capabilities contributing to recovery and economic-social development.

- Advise and assist in strengthening or stabilizing civil infrastructures and services.
- Facilitate transition to peacekeeping or consolidation operations and associated hand-off to other government agencies, international organizations, or host-nation responsibility.

4-128. The CA task force, during competition, enables interactions between military and interagency groups, and interorganizational partners to—

- Respond to humanitarian needs.
- Provide disaster relief.
- Build partner nation capacity and partner nation governance.

4-129. The majority of efforts of the CA task force during competition are completed under 22 USC authority or in support of the civil-military engagement (CME) mission of USSOCOM.

4-130. CA elements, from company through CACOM, retain the ability to form the backbone of CA task forces in order to enhance a supported commander's mission of stabilization. TG, CNDE, CKI, and CMI are essential to effective stabilization efforts. As such, a CA task force empowers the commander with proactive and responsive CAO leading to consolidated gains and preservation of combat power for the supported commander to use in offensive or defensive operations elsewhere in the AO.

4-131. CA task forces are capable of command and control over CA forces and partner elements needed to—

- Increase governance capacity.
- Increase civil security.
- Increase civil control.
- Restore essential services.
- Respond to humanitarian needs.

4-132. When working in joint environments, CA elements also maintain the ability to form the backbone of a JCMOTF. As a supporting commander, the CA task force commander ascertains and fulfills the needs of the supported commander within the imposed parameters. The CA task force commander determines the type of force, employment, and procedures to accomplish the support.

JOINT CIVIL-MILITARY OPERATIONS TASK FORCE

4-133. The JCMOTF is a special-purpose task force made up of units from two or more Services. JFCs may establish a JCMOTF when the scope of CMO requirements and activities are beyond the organic capability of the JFC. The JCMOTF is flexible in size and composition.

4-134. CA commands and brigades can be task organized to form the core of a JCMOTF, and although it is not strictly a CA organization, a CA officer may command the JCMOTF. The JCMOTF will also most likely have CA units as subordinate elements. The JCMOTF plans, prepares, executes, and continually assesses CMO in a theater of operations or joint operations area. The expertise of CA personnel in dealing with government organizations, international organizations, NGOs, and IPI, greatly enhances the opportunity for success. A JCMOTF may have both conventional forces and SOF assigned or attached to support the conduct of specific missions. If the JFC properly charters and establishes the JCMOTF, it must meet the criteria established in JP 3-33.

Transfer in Afghanistan

The fall of Kandahar and Kabul in November of 2001 marked the collapse of the Taliban government and disintegration of its fighting forces. While the organization of the Afghan Interim Authority was taking place, JSOTF-North consolidated the stabilization effort by assigning UW to the three 5th SFG battalion commanders. The Special Operations Command and Control Elements (SOCCEs) were formed to better control operations by various Alliance warlords and to reduce bypassed pockets of Taliban and al-Qaeda resistance around Tora Bora in eastern Afghanistan. A second Ranger parachute assault (Objective Bastogne) seized a remote airfield to support ARSOF attack helicopter operations. Destroying al-Qaeda leaders became a secondary mission for JSOTF-North under the new functional alignment directed by SOCCENT. That was to be the primary mission of the new JSOTF-South. The ADVON of that headquarters relocated to Kandahar Air Base when Marine Corps forces at Objective Rhino moved there. The 10th Mountain Division left K2 for Bagram Air base, south of Kabul. Just days after Hamid Karzai became interim prime minister, the Joint Civil Military Operations Task Force was established in Kabul to direct and coordinate civil and humanitarian affairs in rebuilding Afghanistan. In mid-January 2002, TF Rakkasan from the 101st Airborne Division deployed to Kandahar Airport to replace the Marines...

...3rd SFG at Fort Bragg had been alerted to replace 5th SFG in the combat zone, and 19th and 20th SFG (ARNG) battalion staffs and ODAs were arriving in theater. Mobilized USAR CA and PSYOP units had been "earmarked" to replace Active Army forces in theater...

Weapon of Choice: ARSOF in Afghanistan

CMH Pub 70-100-1

4-135. The JFC may establish a JCMOTF to accomplish a specific contingency mission with a civil-military nature (such as FHA, PRC or transitional military authority) and/or to provide CMO support to U.S. or coalition military forces conducting military operations. Service component and other task force commanders are still responsible for accomplishing the CMO—that is within their ability—in their AOs. When their need exceeds their capability, a JCMOTF assists in meeting the shortfall. A JCMOTF can—

- Be a stand-alone JTF or a subordinate unit in a JTF.
- Assist JTF unit commanders when their organic ability cannot meet the CMO needs of their joint operations area.
- Provide linkage between the JTF and nonmilitary agencies operating in the joint operations area through a CMOC.
- Advise the JTF commander on policy; funding; multinational, foreign, or host-nation sensitivities; and their effect on theater strategy and/or campaign and operational missions.
- Provide command and control or direction of military host-nation advisory, assessment, planning, and other assistance activities by joint U.S. forces.
- Assist in establishing U.S. or multinational and military-to-civilian links for greater efficiency of cooperative assistance arrangements.
- Perform essential coordination or liaison with host-nation agencies; country teams; United Nations agencies; and deployed U.S. multinational, host-nation military forces, and their supporting logistic organizations.
- Assist in the planning and conduct of civil information programs to—
 - Publicize positive results and objectives of military assistance projects.
 - Build civil acceptance and support of U.S. operations.
 - Promote local capabilities contributing to recovery and economic-social development.
- Plan and conduct joint and combined CMO training exercises.
- Advise and assist in strengthening or stabilizing civil infrastructures and services.

- Assess or identify host-nation support, or relief capabilities and funding requirements to the—
 - Commander.
 - JTF for transmission to supporting commanders.
 - Services.
 - Other responsible USG departments or agencies.
 - Facilitate transition to peacekeeping or consolidation operations and associated hand-off to other government agencies, international organizations, or host-nation responsibility.
- 4-136. A JCMOTF should not—
- Be the CMO staff augmentation for a JTF.
 - Have the primary responsible force for accomplishing all CMO in the joint operations area when subordinate to a JTF.
 - Eliminate the need for all units to train for CMO.
 - Eliminate the need for all commanders in the joint operations area to plan and conduct CMO.

Note: JP 3-57 and JP 3-33 provide additional information on the establishment of a JCMOTF and its capabilities.

This page intentionally left blank.

Chapter 5

Unified Action

Commitment to interorganizational cooperation can facilitate cooperation in areas of common interest, promote a common operational picture, and enable sharing of critical information and resources.

JP 3-08, *Interorganizational Cooperation*

Unified action is the synchronization, coordination, and/or integration of the activities of governmental and nongovernmental entities with military operations to achieve unity of effort (JP 1). *Unity of effort* is coordination and cooperation toward common objectives, even if the participants are not necessarily part of the same command or organization, which is the product of successful unified action (JP 1). Unified action partners are those military forces, governmental organizations and NGOs, and elements of the private sector with which Army forces plan, coordinate, synchronize, and integrate during the conduct of operations. Military forces play a key role in unified action before, during, and after operations.

OVERVIEW

5-1. CA plays an integral role in the coordination of military actions with unified action partners. CA forces can provide for better local governance (thereby, relieving commanders of the burden of civil security and civil control), develop networks, share information with interagency and interorganizational partners, and integrate civilian and military actions. CA forces contribute to unified actions through integration, coordination, and synchronization with interorganizational partners, joint forces, and interagency partners.

INTERORGANIZATIONAL COOPERATION

5-2. *Interorganizational cooperation* refers to the interaction that occurs among elements of the Department of Defense; participating United States Government departments and agencies; state, territorial, local, and tribal agencies; foreign military forces and government agencies; international organizations; nongovernmental organizations; and the private sector (JP 3-08). The proper execution of interorganizational cooperation leads to unity of effort through identifying common objectives and building a common understanding. CA forces are integral to this effort through their mandate to interact with civilian populations, organizations, and agencies. Inter-organizational cooperation refers to the interactions between DOD, participating USG departments and agencies, and:

- Domestic governments such as—
 - State.
 - Territorial.
 - Local.
 - Tribal.
- Multinational Elements, including—
 - Foreign military forces.
 - Foreign government agencies.
- International organizations.

- NGOs.
- The private sector, including—
 - Multinational corporations.
 - Academia.
 - Operational contract support.

5-3. CA forces form a critical point in the interaction between U.S. forces and interorganizational partners. This is due to the training that CA forces receive in governance and governmental sector expertise, regional expertise, cultural understanding, and language capabilities. CA forces utilize this interaction to help create a common understanding of the OE. Interorganizational partners can provide local information which may be available through military channels. This information highlights—

- Historical perspectives and insight.
- Local cultural practices.
- Local political structure, political aims of various parties, and the roles of key leaders, which are used to corroborate information provided by Service intelligence and non-intelligence organizations.
- Security situation.
- Role and capabilities of the host-nation government.

5-4. Through development of local civil networks, CA elements are able to increase the capabilities of local governance and add to the common understanding that is essential to unified action. Through CKI and CMI, CA forces collect civil information, produce civil knowledge products, and integrate and share those products in order to increase shared understanding and integrate, coordinate, and synchronize all elements to achieve unity of effort. Through TG, CA elements are able to build local governance capacity in order to enable strengthened local efforts leading to more capable and reliable interorganizational partners.

5-5. One of the most important elements for interorganizational cooperation is a CMOC. The CMOC is the meeting place of stakeholders. It may be physical, virtual, or conducted collaboratively through online networks, or by intermediates (as NGOs may be reluctant to conduct coordination meetings in settings managed by the military). At the joint level the CMOC is formed to:

- Execute the CMO guidance of the JFC.
- Provide liaison with departments, agencies, and organizations.
- Provide a forum for organizations that want to discuss CMO issues and raise concerns, yet maintain their neutrality. Many of these organizations consider the CMOC as a venue for stakeholder discussions but not a stakeholder decision-making forum.
- Receive, validate, and action requests for support from NGOs, international organizations, and the private sector. The CMOC then forwards these requests to the joint force for action.

Note: JP 3-08 provides more information on interorganizational partners.

Note: CA forces interact with multinational partners in support of interorganizational cooperation, and these partners are not always able to receive classified information. CA forces should make every effort available to reduce classification of civil knowledge products that are needed for interorganizational cooperation. Proper foreign disclosure practices must be executed by CA organizations (beginning at the lowest level possible) to ensure timely dissemination of civil knowledge products to interorganizational partners.

Operation DESERT STORM – Kuwait

Strategic planners of Operation DESERT STORM initially focused exclusively on the requirements for combat operations, intending to plan the post-conflict phase when combat operations were over. The timeline for post-conflict planning was sped up when, two months after the Iraqi invasion and occupation of Kuwait on 2 August 1990, the Kuwaiti government-in-exile requested assistance from the U.S. Department of State (DoS) to establish a reconstruction planning structure. Following a briefing on U.S. Army Civil Affairs capabilities by a member of the Joint Staff at the Pentagon, the Kuwaiti contingent petitioned President Bush for CA support to help restore their country. By December 1, 1990, members of the 352d CA Command and the 354th CA Brigade—units mission-focused on the CENTCOM area of operations—mobilized at the U.S. Army Reserve Center in Riverdale Park, MD, to execute this mission. The Kuwait Task Force (KTF), as it was called, was comprised of 57 specially selected officers representing 20 distinct roles of governance organized under the areas of government, economics and commerce, public facilities, and special functions. Among these veterans of the 1989 Panama restoration effort were highly qualified CA Soldiers whose professional skills matched perceived shortfalls, including the Director of USAID's Office of Foreign Disaster Assistance (OFDA) and a senior official of the Justice Department.

Working with representatives of 27 different U.S. government agencies and their Kuwaiti counterparts, the KTF developed plans for executing due process of law regarding suspected Iraqi sympathizers, addressing possible sabotage done by the Iraqis, rebuilding electrical grids, dealing with potential oil fires, furnishing needed food and medicine, and other issues that were codified in Annex G, Civilian Action Plan, which was designed to become part of the USCENTCOM operational plan. The KTF also identified reliable contractors, developed workable procedures, and focused on the sequencing of post-conflict actions for Kuwaiti reconstruction. Upon its arrival in Saudi Arabia in early February 1991, the KTF was assigned to the Combined Civil Affairs Task Force (CCATF) under its parent unit, the 352d CA Command, which, in turn, was assigned to Task Force Freedom, a composite service support unit commanded by the Deputy Commanding General of Army Central (ARCENT). Within the mission structure of Task Force Freedom, the KTF was instrumental in restoring 50 percent of the telecommunications and transportation systems in Kuwait and repairing 30 percent of the devastated electrical grid within one month after the end of combat operations. Not one Kuwaiti died from thirst, starvation, or lack of medical attention after the liberation and there were virtually no acts of retribution or vigilantism directed against suspected collaborators. By the time the KTF departed, the Kuwaiti medical system was operating at 98 percent of its pre-war capacity, the international airport was re-opened, and the police force was fully operational. All major roads and one port were opened while two other ports were being swept of mines. Although the government of Kuwait requested that the KTF remain until December 1991, it was redeployed with its parent unit, the 352d CA Command, on May 10th of that year.

The Kuwait Task Force: Postconflict Planning and Interagency Coordination,
Center for Complex Operations, 2010

JOINT OPERATIONS

5-6. *Joint operations* are military actions conducted by joint forces and those Service forces employed in specified command relationships with each other, which of themselves, do not establish joint forces (JP 3-0). A *joint force* is a force composed of elements, assigned or attached, of two or more Military Departments operating under a single joint force commander (JP 3-0). Almost all military actions interact with the civilian population or affect the civilian population, and it is important to ensure proper civil-military interactions for all operations. U.S. Army CA constitutes the largest proportion of CA forces among the separate

branches of the U.S. military. As such, U.S. Army CA often take on a significant portion of joint CA missions and must plan accordingly.

5-7. When the Army supports the joint force in competition, its role is to shape the OE and prevent conflict by supporting the theater campaign plan of the JFC. The Army does this by supporting security cooperation. The primary purpose of supporting security cooperation is to build relationships and gain access. The secondary purpose is to promote regional stability. Security cooperation is a primary stability operations task. Security cooperation initiated with partner nations promotes regional stability by deterring potential threats.

Note: FM 3-22 and ADP 3-07 provide more information on Army support to security cooperation and stability operations respectively.

CIVIL-MILITARY OPERATIONS DIRECTORATE OF A JOINT STAFF

5-8. The J-9 is the principal staff organization in a joint force command responsible for CMO planning. The J-9 is normally attached or assigned to the supported command to enable the commander and staff in the conduct of CMO. The J-9, in conjunction with other CA forces, execute CMI to synchronize, coordinate, and integrate all military forces and civil entities within a given AO to achieve unity of effort. The J-9—

- Establishes civil-military relationships with—
 - The interagency.
 - International organizations.
 - NGOs.
 - IPI.
- Performs civil-military knowledge management.
- Plans support for civil-military enabling operations.
- Integrates military and civilian organizations that influence operations or campaigns and seeks to promote stability and achieve unified action.
- Provides a conduit for—
 - Sharing civil-military information.
 - Coordinating support requests and activities.
 - Compiling and analyzing relevant information.
 - Performing analysis and evaluation that supports the commander’s assessment.
- Plans the actions of various Service capabilities that enable the joint force to achieve CMO objectives.

5-9. Responsibilities of the J-9 include:

- Serving as staff lead for the organization, employment, and integration of Service CA, military police, medical, engineer, and any other Service capabilities to conduct CMO.
- Establishing liaison, as needed, with interagency partners, international organizations, NGOs, and IPI.
- Providing staff oversight to the CMOC, humanitarian assistance coordination center, joint interagency task force, or joint interagency coordination group—if established by the joint force command.
- Developing Annex G (Civil-Military Operations) and assisting in the development of Annex V to joint operations plans, concept plans, and operation orders.
- Providing civil considerations input and coordinating with the country team, J-3, staff judge advocate, Service component commands, HN, and IPI in the development of transitional public security.
- Coordinating with the comptroller and staff judge advocate to obtain advice on proposed expenditures of allocated funds dedicated to CMO.

- Facilitating the movement, security, and control of funds to subordinate units and coordinating with the funds controlling authority and financial manager to meet the objectives of the commander.
- Planning and supporting transitions (such as terminated, transferred to follow-on forces, or transitioned to USG departments and agencies, IPI, or international organizations), as required.
- Providing expertise and support to the joint interagency coordination group or joint interagency task force, if either is part of the joint staff.
- Managing collection and integration of civil knowledge in the operational area of the supported commander.
- Coordinating with the J-2 for the integration of civil knowledge into the joint intelligence preparation of the OE.
- Coordinating with the comptroller for the disposition of funding for CMO and foreign assistance.
- Coordinating with the J-4 and IPI for host-nation support.
- Coordinating with the J-2 and J-5 to support center of gravity analysis.
- Coordinating with the political advisor of the joint force commander to develop policy for the implementation of transitional military authority.
- Coordinating with the staff, country team, CMOC, joint interagency coordination group, joint interagency task force, humanitarian assistance coordination center, humanitarian operations center, and IPI to ensure planning and execution of FHA.
- Coordinating with the staff, country team, CMOC, joint interagency coordination group, joint interagency task force, and IPI to ensure planning and execution of foreign assistance.
- Coordinating with the staff, country team, CMOC, joint interagency coordination group, joint interagency task force, and IPI to ensure planning and execution of PRC.
- Coordinating with the staff, country team, special operations component command, CMOC, joint interagency coordination group, joint interagency task force, and IPI to ensure planning and execution of CME.
- Coordinating with the country team, J-3, J-4, staff judge advocate, Service component commands, partner nation, and IPI for various permissions and agreements, to include—
 - Access.
 - Status of forces.
 - Overflight.
 - Frequency usage.
 - Land use.
- Participating in the targeting process.

5-10. The J-9 is responsible for Annex G to operation plans, concept plans, and operation orders. Annex G promulgates CMO requirements in a formal plan or operation order. CMO require coordination among CA, maneuver, health support, military police, engineer, transportation, and SOF. CMO also involve interaction between staff sections and subordinate units. Annex G identifies, consolidates, and deconflicts the activities of the various sections and units. Planning and coordination at lower echelons require significantly more details than discussed in Annex G.

Note: CJCS GDE 3130 and JP 3-57 provide additional information on Annex G.

THEATER CIVIL AFFAIRS PLANNING TEAM

5-11. At geographic combatant commands that have an established J-9, the theater CAPT is a complementary capability and serves to strengthen the directorate's efforts. The J-9 and theater CAPT develop, integrate, synchronize, and coordinate CMO plans, policies, programs, and operations in coordination with theater-aligned CA forces and interagency entities. These are integrated with, and enhance the strategic plans, campaigns or operations, and theater security cooperation initiatives of the geographic combatant command.

JOINT TASK FORCE

5-12. Just as in the military decision-making process, CA Soldiers on the J-9 staff provide the commander with an analysis of the civil components that shape the OE during the joint planning process. While not all geographic combatant commands have this staff section organic to their joint manning document, CA has the capability to provide persistent or episodic planning elements to assist any level JFC with integrating CMO into plans.

5-13. Civil considerations are evaluated for those aspects of the OE that directly affect a mission. The CMO staff provides the commander with detailed civil considerations analysis focused on the civil component of the AO. CMO planners further develop and implement their plans in conjunction with civilian officials from other USG agencies and other nonmilitary organizations in order to synchronize U.S. and multinational efforts. The J-9 responsibilities include, but are not limited to—

- Determining if there is a requirement for a CMOC to maintain liaison with unified action partners, IPI, interagency, NGOs, and international organizations in the AO.
- Advising the JFC and staff on legal and moral considerations as they pertain to the civil component.
- Participating in the targeting process.
- Ensuring CMO is synchronized with IO.
- Analyzing the effects of civilian populations on military operations.
- Analyzing the effects of military operations on the civil component.
- Assessing the host-nation resources to support military operations.
- Identifying nongovernmental and other independent organizations operating in the AO.
- Recommending CA force requirements.
- Participating in required boards, cells, and working groups, as required.
- Maintaining the CMO staff estimate.
- Developing Annex G.
- Assisting the J-3 with development of Annex V.

Note: JP 5-0 provides the doctrinal discussion, process, and formats for joint planning.

CIVIL-MILITARY OPERATIONS PLANNING CONSIDERATIONS

5-14. In order to plan successful CMO, CA planners must consider all aspects of the civil component, the national security policy and objectives, and national and theater military objectives. Although the following list is not intended to be all-inclusive, CA planners must consider—

- Host-nation and regional legal institutions, customs, social relationships, economic organizations, and concepts of human and fundamental rights.
- Input to the development of transitional public security planning and execution.
- Public education.
- Cultural and religious leaders.
- Public health and sanitation.
- Labor, procurement, and contracting leaders.
- DC care and control, civilian supply, public safety, transportation, and humanitarian relief.
- International laws, customs, and practices governing the sovereign territory of each nation.
- The use of water, air, and land as it relates to the IPI.
- The ability to communicate with IPI.
- Criminal activities and the informal economy impacting the economic environment.
- Competing requirements and agendas of multiple stakeholders.
- Administrative, logistic, and communications support requirements of CMO forces.
- The need for early deployment and employment of CMO forces.

- The coordination of CMO requirements with other appropriate staff functions, the interagency, international organizations, NGOs, HN, and private sector.
- Additional lead time normally necessary for the availability of reserve component forces.
- CMO input to the targeting process will help reduce destruction of essential civilian capabilities needed during stabilization.
- The tactical, operational, and strategic objectives achievable via CMO.
- Recommendation of the formation of a JCMOTF, as required.
- Crop cycles of the HN.
- Historical events and local holidays of the HN.

CIVIL-MILITARY OPERATIONS WORKING GROUP

5-15. Commanders establish CMO working groups to bring all the stakeholders in CMO together to focus and synchronize their efforts in achieving the CMO priorities of the commander. In addition to the CMO working group, the CAO or CMO planners ensure that they are actively involved in the IO working group; the intelligence fusion working group; the targeting board; and other boards, cells, and working groups relevant to the current operation.

5-16. The composition of the CMO working group changes based on level of command but the lead CMO planner (J-9, G-9, or S-9) should chair the group. Other members of this working group may include the following:

- Director of the CMOC.
- Subordinate CA unit representative.
- PSYOP staff.
- IO representative.
- Medical representative.
- Engineer representative.
- Provost marshal or representative.
- Staff judge advocate representative with expertise in CMO, preferably the unit's senior rule of law officer.
- Chaplain or religious affairs noncommissioned officer.
- Interagency representative, if applicable.
- Political advisor, if applicable.
- Public affairs officer.
- J-2, G-2, or S-2 targeting officer representative.
- J-3, G-3, or S-3 current operations representative.
- J-4, G-4, or S-4 representative.
- Resource management representative.
- Subordinate liaison officer.

Civil-Military Operations Working Groups in Operation ENDURING FREEDOM

During Operation ENDURING FREEDOM (May 2004 through March 2006), the Combined Joint Special Operations Task Force-Afghanistan recognized the need to secure the Shur Ghar Pass in southern Afghanistan. Close collaboration between CA, coalition forces, IPI, NGOs, international organizations, USAID, DOS, the U.S. Department of Agriculture, the UN, and others produced an excellent example of a civil-military operations working group.

The Shur Ghar Pass is in central Zabul Province in southern Afghanistan. The pass sits in a mountain range that splits the province. The surrounding mountains make approaches to the pass unobservable. In addition, the rock-strewn sand road makes it an ideal location for improvised explosive devices and ambushes. Several coalition soldiers lost their lives in the pass due to these threats.

Through numerous civil-military operations working groups at Kandahar Air Base and Zabul Province, CA Soldiers from the 96th CA Battalion (A) and coalition forces prepared a concept to secure the Shur Ghar Pass. The concept included placing Afghan police in the pass, building a hardened police barracks compound, and instituting numerous police checkpoints. Personnel secured Commander's Emergency Response Program (CERP) funding to build the police barracks and checkpoints in the pass. CA Soldiers supporting the task force coordinated with the commander of joint task force 76 to use CERP funding provided by the provincial reconstruction team (PRT) in Qalat, the capital of Zabul Province. CA forces eventually transferred the plan to the commander of Joint Task Force 76, specifically 3d BCT, 25th Infantry Division, and the Qalat PRT. The DOS contractors from DynCorp ran a police training program in Zabul, in conjunction with the 3d BCT, 25th Infantry Division that produced trained police to staff the pass.

When the 3d BCT, 25th Infantry Division redeployed, the plan to secure the Shur Ghar Pass was transferred to the 173d (A) BCT. The 173d (A) BCT dedicated virtually all its engineer assets to complete the initial road cut and base course. With approval from the commander of Joint Task Force 76, the Qalat PRT funded road construction equipment and a rock crusher and was able to provide training for Afghans to operate them. USAID agreed to fund an asphalt-finish topcoat using a private contractor to pave the road.

This collaborative effort took over a year from conception to completion. It involved civil-military operations working groups at the strategic, operational, and tactical levels and was composed of elements from SOF and conventional forces, USAID, the DOS, the government of Afghanistan, and others to make it successful. The net result produced secure access to southern Afghanistan for coalition and Afghan security forces. It stimulated the economy in Zabul Province and southern Afghanistan, and legitimized the local governments, the provincial government, and the government of Afghanistan.

JOINT INTERAGENCY COORDINATION GROUP

5-17. The *joint interagency coordination group* is a staff group that establishes regular, timely, and collaborative working relationships between civilian and military operational planners (JP 3-08).

Note: JP 3-08 provides additional information on the joint interagency coordination group.

5-18. A CACOM has the capabilities to provide theater-level analysis of civil considerations in coordination with the joint interagency coordination group (or equivalent organization) and to develop strategic-level civil input to the supported JFC. A J-9 staff section plans, coordinates, and provides staff oversight of CMO and civilian component issues through direct coordination with the J-3 of the supported unit. Throughout the

process, the plans officer of the CACOM staff continuously ensures the fusion of the civil inputs received from subordinate CA elements, maneuver elements, USG agencies, NGOs, international organizations, and host-nation sources to the common operational picture of the JFC. The integration of CMO into the staff or working group is imperative. The capabilities of the private sector partnership, when orchestrating interagency coordination, is extremely valuable.

CIVIL-MILITARY ENGAGEMENT

5-19. CME is part of the DOD's strategy, to building partner nation capacity in a preventive, population centric, and indirect approach to enhance the capability, capacity, and legitimacy of partnered indigenous governments. It is persistent engagement conducted by, with, and through unified action partners to shape and influence the IPI within the OE in support of the campaign plans of the commander and the campaign support plan of the theater special operations command (TSOC). CME is also and executed in conjunction with U.S. embassy strategies. The conduct of CME—

- Increases the capability of USG-supported IPI.
- Reduces the influence of malign actors within targeted countries and regions.
- Leverages civil vulnerabilities and resiliencies within the OE.

5-20. CME identifies and addresses critical civil strengths and vulnerabilities in under-governed and ungoverned areas or high-threat environments where host-nation authorities, the country team, or USAID cannot operate. These objectives are accomplished through the conduct of CAO during the execution of the following CME program key tasks:

- **CR.** CME elements conduct CR to observe and evaluate specific aspects of the civil environment to fulfill information requirements. CME practitioners must understand the overall preparation of the environment plan during the conduct of CR. By planning and executing targeted CAO that influences unified action partners and IPI relationships and resources, CA elements help shape the OE, thereby contributing to preparation of the environment efforts.
- **Network Analysis.** Regional and theater civil-military support elements (CMSEs) conduct network analysis and evaluation to identify critical and relevant nodes. This is done by using CNDE and CKI to partner with friendly networks and engage neutral networks in order to counter threat networks. Network analysis is executed with the purpose of determining, analyzing, and evaluating links between these nodes as a means of gaining an understanding of a group, place, physical object, or system.
- **Network Engagement.** Regional CMSEs and CMSEs conduct network engagement to engage critical nodes within friendly and neutral networks in order to counter threat networks. All the data and information gathered through CR and CE are used during the CKI process. Network engagement is conducted continuously and simultaneously at all levels of warfare to help achieve the commander's objectives within the OE.
- **Interorganizational Cooperation.** Inter-organizational cooperation enables unity of effort, common objectives, and a common understanding by synchronizing actions. It facilitates cooperation in areas of mutual interest, promotes a common operational picture, and enables the sharing of critical information and resources that contribute to economy of force in accomplishing TSOC objectives.
- **Capacity Building.** Capacity building develops the capability and capacity—within friendly and neutral networks—to counter malign actor influence and activities. Capacity building increases host-nation government and military capacity to reduce the causes of instability, thereby denying malign actor influence.

5-21. The CME program consists of four distinct capabilities-based, task-organized units of action. These units of action include:

- **CMSE.** A *civil-military support element* is a **task-organized Civil Affairs force established to plan, facilitate, and execute Civil Affairs operations in support of civil-military engagement in a specified country, region, or theater.** The CMSE is primarily sourced by a special operations CAT. Through CAO, the CMSE conducts planned and targeted CR and CE, engaging networks to affect the behavior and will of relevant actors, audiences, and adversaries in the OE in support of combatant command campaign plans, the TSOC campaign support plan, and in conjunction with U.S. embassy strategies.
- **Regional CMSE.** The regional CMSE conducts network engagement and analysis within a subordinate command architecture to the TSOC, and is primarily sourced by a special operations CA company. It conducts tactical to operational level human network analysis to comprehensively study and understand the relationships of networks to support preparation of the environment. The regional CMSE is a task-organized unit of action based upon mission specific requirements with the ability to conduct command and control of the CME elements in their assigned region to achieve desired effects.
- **Theater CMSE.** The theater CMSE is primarily sourced by elements from a special operations CA battalion headquarters and is filled based upon specific mission requirements. It conducts and integrates network analysis into the joint planning process, joint intelligence preparation of the OE, and the joint targeting cycle. The theater CMSE is collocated with a theater-level special operations command and control node. It also has the ability to conduct command and control of the CME elements in their theater to achieve desired affects.
- **Trans-Regional CME Element.** The trans-regional CME element is sourced from special operations CA personnel assigned to USSOCOM who carry out their duties at interorganizational partners in USSOCOM-identified priority locations. This unit of action is tasked with developing and maintaining long-term relationships through an enduring presence across the unified action partner network to enhance trans-regional synchronization and improve inter-organizational cooperation.

5-22. Trans-regionally and persistently engaged CME elements conduct targeted CAO to increase the capability of USG-supported IPI and to reduce the influence of malign actors within targeted countries and regions. These elements leverage civil vulnerabilities and resiliencies within the OE in support of the campaign plans of the CCDR and the TSOC campaign support plan, and in conjunction with U.S. embassy strategies.

INTERAGENCY COORDINATION

5-23. Interagency coordination is the cooperation and communication that occurs between agencies of the USG, including the DOD, to accomplish an objective. The accomplishment of strategic objectives identified in U.S. national security policy requires a whole-of-government approach that achieves unity of effort.

The Tsunami Relief Disaster in the Indian Ocean

The Indian Ocean tsunami disaster-relief effort at the end of 2004 is a good example of interagency cooperation, collaboration, and communication. As both DOD and OFDA rapidly responded to the disaster areas, both realized the need for close cooperation and coordination. OFDA dispatched liaison officers at the tactical level to CMOCs operating in Sri Lanka, Indonesia, and Thailand, as well as at USPACOM. The DOD similarly embedded liaison officers at OFDA's response management team in Washington, DC. These steps greatly simplified the request for assistance process from international organizations and NGOs and increased the ability of both organizations to respond effectively and quickly to those affected by the disaster.

FM 3-05.401, *Civil Affairs Tactics, Techniques, and Procedures*

Note: FM 3-05.401 is an obsolete publication, which provides historical reference and is listed in the Obsolete Publications section of the references for this FM.

5-24. CA forces enable interagency coordination through organizational structures at the strategic, operational, and tactical levels including—

- J-9.
- Theater CAPT.
- G-9.
- CAPT.
- S-9.
- CMOCs.
- Civil-military advisory group.
- Theater CMSE.
- Regional CMSE.
- Civil liaison teams (CLTs).
- CMSE.
- CATs.

Note: JP 3-08 provides additional information regarding interagency coordination.

5-25. The DOS is the lead entity when coordinating between interagency partners of any given country. The DOS is also the lead in establishing an international agreement. The DOD and its components are governed by international agreements under DODI 5530.3 (figure 5-1, page 5-12), and that authority is limited under Title 22, Code of Federal Regulations, Part 181.

5-26. When not engaged in a forcible entry, invasion, or occupation, military forces are not permitted in foreign countries in their official capacity without authority being advanced through an international agreement or country clearance of some type. Access granted by the permissions manager is designated as part of joint deployment and redeployment operations. Therefore, they must be addressed in a bilateral or multilateral agreement, which is consummated by the U.S.

5-27. Contingency basing (agreement to stay in a country) must be negotiated with a foreign country unless basing is being established through forcible entry and establishing a lodgment. Such basing can be authorized through a bilateral agreement also called a defense cooperation agreement. It can also be negotiated through a status-of-forces agreement or a “diplomatic note”. These international agreements are sometimes referred to as host-nation agreements or host-nation support agreements or diplomatic agreements in common usage. In such agreements use of existing HN, host country, or partner nation bases can be utilized. If new construction is occurring or land is set aside for U.S. forces, it usually requires a separate land use agreement.

Note: See JP 3-0, JP 3-34 and JP 3-35 for more information about deployment and redeployment, joint engineer operations, and joint operations.

International Agreements (DODI 5530.3)

An international agreement is any agreement concluded with one or more foreign governments (including their agencies, instrumentalities, or political subdivisions) or with an international organization, that—

- Is signed or agreed to by personnel of any DOD component, or by representatives of the DOS or any other Department or Agency of the U.S. Government.
- Signifies the intention of its parties to be bound in international law.
- Is denominated as an international agreement or as a memorandum of understanding, memorandum of agreement, memorandum of arrangements, exchange of notes, exchange of letters, technical arrangement, protocol, note verbal, aide memoire, agreed minute, contract, arrangement, statement of intent, letter of intent, statement of understanding or any other name connoting a similar legal consequence.

Any oral agreement that meets the criteria set forth in DODI 5530.3 is an international agreement. The DOD representative who enters into the agreement will cause such agreement to be reduced to writing.

During a state of war, the Law of War (codified in the Geneva-Hague Conventions), permits local “special” agreements in some cases, that are necessitated by interaction at the tactical and operational level.

The following are not considered to constitute international agreements for the purposes of this Directive:

- Contracts made under the Federal Acquisition Regulations.
- Foreign Military Sales Credit Agreements.
- Foreign Military Sales Letters of Offer and Acceptance and Letters of Intent.
- Standardization agreements, quadripartite standardization agreements, Army Service component command air standards, and naval standardization agreements in accordance with DODI 5530.3.
- Leases under Title 10, United States Code, Sections 2667 and 2675 (reference [f]), and Title 22, United States Code, Section 2796 (reference [l]).
- Agreements solely to establish administrative procedures.
- Acquisitions or orders pursuant to cross-servicing agreements made under the authority of the North Atlantic Treaty Organization Mutual Support Act (Title 10, United States Code, Section 2321 et seq. (reference [f]) and DODD 2010.9 (reference [m])). (Umbrella agreements, implementing arrangements, and cross-servicing agreements under the North Atlantic Treaty Organization Mutual Support Act are international agreements.)

Figure 5-1. International agreements according to Department of Defense Issuance 5530.3

5-28. DODI 5530.3 governs the DOD responsibilities regarding such agreements. In essence, the DOD defers to the DOS in the negotiation of international agreements and it binds the DOD to adhere to such agreements.

5-29. CA forces, in conjunction with the judge advocate general, must understand these agreements in order to advise commanders on what their forces can and cannot do in keeping with the U.S. obligations to an HN, or partner nation. This advice would also include the interaction of U.S. forces with IPI or other foreign nationals. CA forces also play a significant role in achieving unified action and integrating, coordinating, and synchronizing with civilian entities in keeping with the international agreements.

5-30. International agreements can be bilateral (between the U.S. and a partner nation) or multilateral (such as the North Atlantic Treaty Organization). Bilateral agreements can be negotiated on any number of international matters—to include economic, trade, or defense cooperation. Bilateral defense cooperation agreements are referred to as defense cooperation agreements or less formal agreements can be negotiated as simply diplomatic notes exchanged between foreign ministers.

Note: U.S. DOS Foreign Affairs Manual, Correspondence Handbook, describes the use of diplomatic notes (5 FAH-1).

5-31. Commanders have limited authority to negotiate or interact at a tactical or operational level. Such interaction is limited to special agreements as addressed under the law of war. Such agreements are typically verbal and must not have an adverse effect on protected persons (such as prisoners of war or civilians). Special agreements are binding between those governments or military commanders that made the agreements. When engaging the civil component, CA Soldiers often negotiate and make agreements with segments of the populations, HN, or partner nation institutions.

THE ROLE OF UNITED STATES EMBASSIES

5-32. An embassy is the headquarters for USG representatives serving in a foreign country. It is normally led by an ambassador, who is the representative of the U.S. President to the host country. An embassy is normally located in the capital city. It may have branches, known as consulates, in other cities.

5-33. U.S. embassies and consulates abroad, and foreign embassies and consulates in the United States, each have special status. While the host government is responsible for the security of U.S. diplomats and the area around an embassy, the embassy belongs to the country it represents. Representatives of the host country cannot enter an embassy without permission—even to put out a fire—and an attack on an embassy is considered an attack on the country it represents.

5-34. The ambassador, also known as the chief of mission, is the highest-ranking diplomat to the host country and is the personal representative of the President. This person is comparable to a CEO of a corporation and has to be a strong leader and a good manager. The ambassador is supported by a deputy, known as the deputy chief of mission, and a team of U.S. foreign service officers and specialists from the DOS. The ambassador may also be supported by representatives from other U.S. agencies, such as the USAID DOD, Department of Commerce, Department of Justice, Department of Homeland Security, and so on. No matter their agency, all employees work under the direction of the ambassador.

5-35. The primary purpose of an embassy is to assist American citizens who travel to or live in the host country. U.S. Foreign Service Officers also interview citizens of the host country who wish to travel to the U.S. for business, education, or tourism purposes. Embassy staff interact with representatives of the host government, local businesses, nongovernmental organizations, the media and educational institutions, and private citizens to increase understanding of the U.S. and its policies and to collaborate on shared interests.

5-36. Embassy staff analyze the political and economic situation in the host country and report back to the DOS on issues that affect the United States. They help U.S. businesses find partners and customers, and may train the police and military of the host government to support better security in the country. They also sponsor educational, professional, and cultural exchanges to introduce emerging and established leaders to the U.S., and to promote ties between U.S. and foreign students, academics, scientists, entrepreneurs, political, religious, and civil society figures.

5-37. While Americans work at embassies and consulates, most of the staff comes from the host country. These employees are essential to the success of any embassy because they know the local culture, have essential skills, or are well-connected to government and civil society leaders.

5-38. A large embassy may have annexes. The main embassy building is called the chancery. As the public face of the U.S., it is often an architectural work of art. In some countries, American staff may live on the embassy compound, but they frequently live in apartments or houses in the host city. The residence of the ambassador is often used for official functions, and its public areas are often decorated with American art on loan from museums.

5-39. While each U.S. embassy is different, CA Soldiers may interact with embassy stakeholders, such as defense attachés, political and economic officers, and USAID mission personnel. While the missions CA Soldiers support will most likely fall under the authority of geographic CCDRs (not under the authority of Chiefs of Mission), it is still critical for CA Soldiers to—

- Understand the U.S. foreign policy objectives in the host country.
- Understand the status of the bilateral relationship.
- Ensure that all activities conducted in country are mutually supportive of the U.S.-host nation objectives.

DEFENSE SUPPORT TO STABILIZATION

5-40. The DOD provides support to stabilization as directed in DODD 3000.05. Stabilization is an inherently political endeavor that requires aligning USG efforts—diplomatic engagement, foreign assistance, and defense—to create conditions in which locally legitimate authorities and systems can peaceably manage conflict and prevent violence. The DOS is the overall lead federal agency for U.S. stabilization efforts in accordance with NSPD-44. The USAID is the lead implementing agency for non-security U.S. stabilization assistance. The DOD is a supporting element, which performs several functions—including providing requisite security and reinforcing civilian efforts where appropriate and consistent with available statutory authorities.

5-41. The DOD is required to establish a defense support to stabilization process to—

- Identify defense stabilization objectives in concert with other USG departments and agencies.
- Convey the defense stabilization objectives through strategic documents.
- Organize to achieve the defense stabilization objectives.
- Prioritize requisite defense resources.

5-42. The DOD is also required to ensure Annex G and Annex V are fully developed and integrated in global campaign plans, concept plans, and operation plans, in accordance with JP 5-0.

STABILIZATION AND SECURITY COOPERATION

5-43. As part of SCA, CA forces conduct stabilization and security cooperation activities in an effort to strengthen local governance and build partner capacity. *Security cooperation* is all Department of Defense interactions with foreign security establishments to build security relationships that promote specific United States security interests, develop allied and partner nation military and security capabilities for self-defense and multinational operations, and provide United States forces with peacetime and contingency access to allied and partner nations (JP 3-20). Stabilization and security cooperation are mainly, though not solely, accomplished through foreign assistance, FHA, FID, support to counterinsurgency, and the CME program of USSOCOM.

FOREIGN ASSISTANCE

5-44. Foreign assistance is civil or military assistance rendered to a foreign nation through development assistance, humanitarian and civic assistance, and SA. The U.S. provides foreign assistance through security cooperation in conjunction with the theater security cooperation plan of a geographic CCDR. Foreign assistance can also be provided when the U.S. is sponsoring a FID program or FHA in conjunction with other security cooperation efforts. Foreign assistance operations support an HN by promoting sustainable development and growth of responsive institutions. The goal is to promote long-term regional stability.

5-45. Figure 5-2 highlights the components of foreign assistance, which can be divided into three broad categories:

- **SA.** This fosters stability and security abroad by strengthening the military and law enforcement forces in our partner countries through capacity building and training and helps countries purchase defense equipment and services produced in the U.S.
- **Economic and Development Assistance.** This advances our national security by helping countries meet near-term political, economic, and development needs.
- **HA.** This supports disaster and emergency relief efforts, including programs that save lives, alleviate suffering, and maintain human dignity.

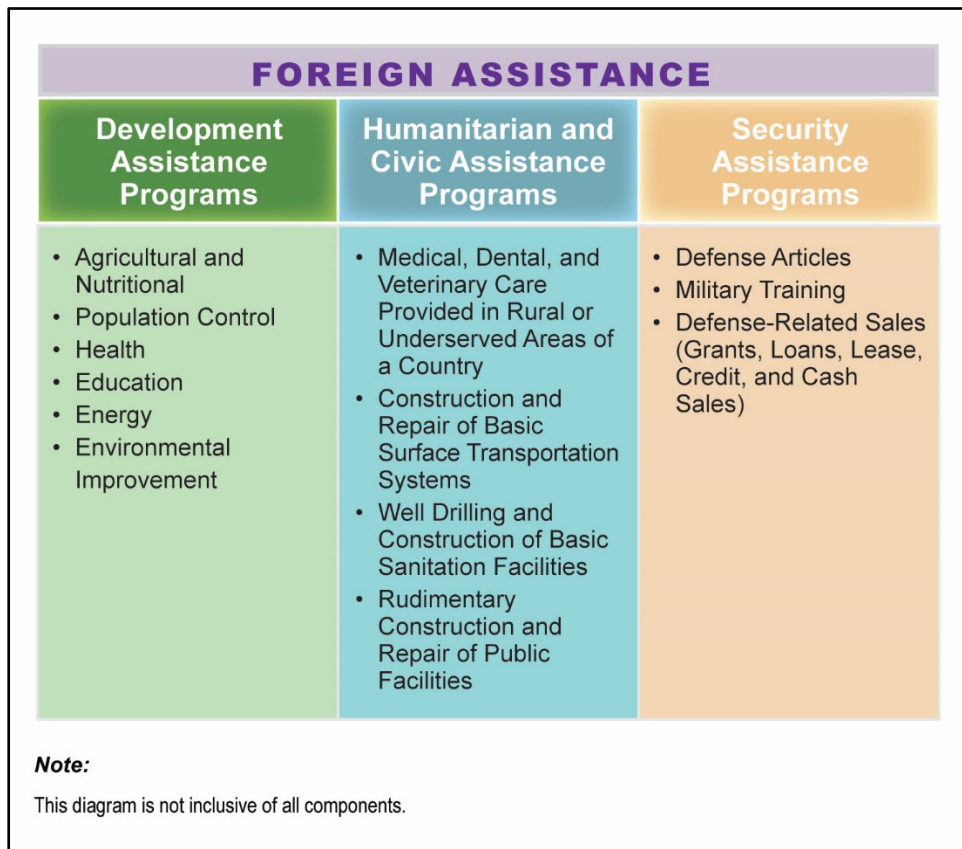


Figure 5-2. Components of foreign assistance

5-46. CAO focus on the civil component during foreign assistance to provide the commander with viable courses of action to assist in the stabilization of the populace and resources in an AO. This focus assists the commander in synchronizing efforts and capabilities in the most efficient manner possible. Ultimately, CA will reduce the redundancy of resources, maximize the usage of the current infrastructure, and assist in the coordination of unified action partners, IPI, and interagency groups supporting foreign assistance operations.

5-47. CA forces possess the capabilities to evaluate the civil component through the planning and execution of TG, CNDE, CKI, and CMI, in support of foreign assistance. The focus of foreign assistance programs is to legitimize and enhance the stability of the political, military, economic, social, informational, and infrastructure systems of an HN. CA forces provide a sociocultural understanding of the OE that enhances the ability of the U.S. to achieve the desired end state. Support to foreign assistance can include technical expertise, advice, and assistance that can exponentially influence the success of other ongoing programs and initiatives. This assistance forms a better foundation on which a nation can build programs to meet the needs of the populace and promote its own sustainable development or growth. CA forces assist in the development of these programs and provide assessments to the commander on their effectiveness and sustainability.

Note: ATP 3-57.30 provides additional information regarding SA, FID, and 10 USC authorities that oversee these missions.

DEVELOPMENT ASSISTANCE PROGRAMS

5-48. A principal objective of the foreign policy of the U.S. is the encouragement and sustained support to people of developing countries for improving the quality of their lives. Development assistance programs are programs executed by the DOS directly or indirectly, through USAID, which finances numerous development assistance programs to address the following needs:

- Agriculture and nutrition.
- Population control.
- Health.
- Education.
- Energy.
- Environment improvement.
- Humanitarian and civic assistance programs.
- Economic programs.

5-49. CA forces support these named needs with the full range of SCA.

5-50. Humanitarian and civic assistance programs are governed by 22 USC and 10 USC 401. This assistance can only be provided in conjunction with military operations and exercises, and it must fulfill unit training requirements that incidentally create humanitarian benefit to the local populace. In contrast to emergency relief conducted under FHA operations, humanitarian and civic assistance programs generally encompass planned activities in the following categories:

- Medical, surgical, dental, and veterinary care (and their associated education, training, and technical assistance) provided by professionals in each practice in rural or underserved areas of a country.
- Construction and repair of basic surface transportation systems.
- Well drilling and construction of basic sanitation facilities.
- Rudimentary construction and repair of public facilities.

5-51. CA units and personnel supporting humanitarian and civic assistance provide capabilities of CNDE and CMI with an understanding of the cultures within the HN.

SECURITY ASSISTANCE PROGRAMS

5-52. SA programs are governed by 22 USC. SA is a group of programs authorized by the *Foreign Assistance Act of 1961* (as amended) and the *Arms Export Control Act of 1976* (as amended). SA is also authorized by other related statutes through which the U.S. provides defense articles, military training, and other defense-related services, by grant, loan, credit, or cash sales in furtherance of national policies and objectives.

5-53. According to JP 3-22, SA is an element of security cooperation funded and authorized by the DOS, to be administered by the DOD or Defense Security Cooperation Agency. Through these programs, the U.S. provides defense articles, military training, and other defense-related services to foreign nations. These programs are implemented by the DOD in accordance with policies established by the DOS. The principal components of these programs include foreign military sales, foreign military financing, international military education and training, peace operations, and excess defense articles.

5-54. CA personnel in support of these SA programs can—

- Identify host-nation requirements.
- Develop or review the nomination list of programs or projects to support the mission objectives.
- Provide input to the feasibility of each program.
- Provide input to the prioritization of each program to meet the desired end states and goals.

FOREIGN HUMANITARIAN ASSISTANCE

5-55. *Foreign humanitarian assistance* is Department of Defense activities conducted outside the United States and its territories to directly relieve or reduce human suffering, disease, hunger, or privation (JP 3-29). Most USG agencies, as well as USC and DOD directives, utilize the terms humanitarian assistance and foreign disaster relief.

5-56. FHA operations are different from foreign assistance primarily because they have a direct humanitarian need. The DOD uses appropriated funds specifically for FHA in the form of overseas humanitarian disaster and civic aid. Foreign assistance is not funded by overseas humanitarian disaster and civic aid, and it is intended as deliberate assistance to promote long-term stability. FHA activities conducted by U.S. armed forces fall into two broad categories:

- **Steady-state FHA.** Steady-state FHA are activities normally planned and conducted as part of the theater campaign plan of the geographic CCDR. The intent of steady-state FHA activities is to assess and increase the affected nation's capacity and capability to respond to disaster. Steady-state FHA is a security cooperation tool that can improve visibility, access and influence. It can also promote regional stability with foreign military and civilian counterparts and increase interoperability between that nation and U.S. forces in the event that U.S. forces have to respond in support of foreign disaster relief.
- **Foreign Disaster Relief.** Foreign disaster relief is a limited duration contingency operation. The goal of foreign disaster relief is to alleviate the suffering of foreign disaster victims—including victims of natural disasters and conflicts, internally displaced persons, refugees, stateless persons, and vulnerable migrants. Normally, foreign disaster relief includes:
 - Provision of basic services and commodities, such as food, water, sanitation, health care, nonfood items (clothing, bedding, and so on), and emergency shelter.
 - Establishment of distribution points and collection points.
 - Support to critical infrastructure and logistics necessary for the delivery of those essential services and commodities.
 - Medical equipment, medical and technical personnel, and making repairs to essential services.

5-57. DODD 5100.46 directs that DOD components will provide disaster assistance in support of U.S. foreign disaster relief efforts only in any of the three following instances:

- At the direction of the President.
- When the SecDef or a designee approves (with the concurrence of the Secretary of State) a request for assistance from another federal department or agency.
- In emergency situations in order to save human lives where there is not sufficient time to seek the prior concurrence of the Secretary of State, in which case the SecDef will advise and seek the concurrence of the Secretary of State as soon as practicable thereafter.

5-58. Nothing in DODD 5100.46 will be construed as preventing a military commander with assigned forces at or near the immediate scene of a foreign disaster from taking prompt action to save human lives. In cases in which this authority is invoked, the commander should obtain the concurrence of the HN and U.S. Chief of Mission of the affected country before committing forces. Also, the CCDR will follow up as soon as possible (but no later than 72 hours after the start of relief operations) to secure SecDef or Deputy SecDef approval for continuing assistance. CCDRs must also obtain SecDef or Deputy SecDef approval in order to obtain reimbursement with Overseas Humanitarian, Disaster, and Civic Aid funds. Such assistance during the first 72 hours does not include the authority to provide military assistance that does not contribute to urgent life-saving efforts.

5-59. Although U.S. military forces are primarily designed and structured to defend and protect U.S. national interests, they may be readily adapted to FHA requirements. Military organization, structure, and readiness enable commanders to rapidly and effectively respond when time is of the essence. In addition to—or sometimes in lieu of—host-nation humanitarian assistance efforts, hundreds of NGOs from around the world respond to disasters to provide humanitarian assistance in various forms and for varied durations. However, U.S. military forces are not the primary USG means of providing FHA. They normally supplement the activities of U.S. and foreign government authorities, NGOs, and international organizations. The USAID

is the principal agency for U.S. bilateral development and humanitarian assistance to foreign countries. The USAID will normally serve as the lead federal agent for the U.S.

5-60. FHA missions conducted by U.S. military forces span the full competition continuum. This could be from crisis response and limited contingency operations to activities in various steady-state programs as part of the security cooperation program of the geographic CCDR, or to achieve specific theater campaign plan objectives.

5-61. DODD 5105.65 assigns the Defense Security Cooperation Agency the responsibility to direct, administer, and provide DOD-wide guidance for the execution of DOD SA and security cooperation. It further directs the Defense Security Cooperation Agency to provide oversight and exercise overall program management responsibility for DOD humanitarian assistance and demining activities funded by the Overseas Humanitarian Disaster and Civic Aid appropriation, in coordination with the Assistant Secretary of Defense for Special Operations and Low Intensity Conflict. The directive directs the Defense Security Cooperation Agency to produce Defense Security Cooperation Agency manual 5105.38-M. This manual provides policy and direction for humanitarian assistance.

5-62. The CA role in FHA is to assist the commander in planning; advising on the activities; and coordinating with unified action partners, IPI, and interagency to synchronize efforts. CA forces also play a key role in conducting assessments. FHA operations are inherently complex and require a significant amount of interagency coordination. FHA is normally directed from the strategic level, planned and managed at the operational level, and conducted at the tactical level. On all levels, in support of FHA activities, CA forces—

- Participate in interagency assessment, planning and synchronization of FHA activities.
- Identify, validate, or evaluate host-nation and international resources available for FHA activities.
- Mobilize vetted and developed civil networks to aid in FHA activities.
- Advise, assist, and plan displaced civilian movement and control.
- Participate in the execution of selected FHA activities as directed.
- Provide liaison with IPI.
- Assist in the coordination of local labor.
- Coordinate with judge advocates to assist the commander to meet legal and moral obligations.
- Monitor and evaluate FHA.
- Assess requirements and support for the operation of a CMOC.
- Conduct and maintain an assessment of humanitarian issues in designated nations or regions.
- Identify shortfalls in host-nation humanitarian assistance programs and resources.

5-63. Although FHA operations may be executed simultaneously with other types of operations, each type has unique characteristics. For example, FHA operations may be simultaneously conducted with peace operations, but each has its own strategic end state. Military commanders must be cautious not to commit their forces to projects and tasks that go beyond the FHA mission. Military commanders conducting FHA simultaneously with other operations must develop end state, transition, and termination objectives, as well as measures of effectiveness and measures of performance complementary to simultaneous military operations. Civil networks developed and integrated into operations through the CNDE process aid in execution of FHA tasks, thereby relieving commands of resource demands that might take away from completion of other operations.

5-64. One example of FHA is humanitarian mine action, which includes activities related to the furnishing of education, training, and technical assistance with respect to detection, clearance, physical security, and stockpile management of land mines and other explosive remnants of war. Explosive remnants of war include landmines, unexploded ordnance (mortar rounds, artillery shells, bomblets, rockets, sub-munitions, rocket motors and fuel, grenades, small arms ammunition, and so on), and abandoned ammunition storage and cache sites. The CA role in humanitarian mine action is normally to assist with the request and approval process and to assist the HN in establishing a national demining office.

5-65. There are many operations that are related to FHA. These operations are diverse and CA forces will support these related operations as necessary. The related operations consist of—

- Stability operations.
- Foreign assistance, to include—
 - Humanitarian and civic assistance.
 - SA.
 - Development assistance.
- Peace operations.
- Noncombatant evacuation operations.
- Mass atrocity response operations.
- International chemical, biological, radiological, and nuclear response.

FOREIGN INTERNAL DEFENSE

5-66. *Foreign internal defense* is the participation by civilian and military agencies of a government in any of the action programs taken by another government or other designated organization to free and protect its society from subversion, lawlessness, insurgency, terrorism, and other threats to its security (JP 3-22). The focus of U.S. FID efforts is to support the internal defense and development of the HN. Internal defense and development can be described as the full range of measures taken by a nation to promote its growth, and protect itself from security threats. Figure 5-3 depicts the interrelationship of security cooperation, SA, and FID.

5-67. In FID, CAO facilitate the integration of U.S. military support into the overall internal defense and development programs of the supported nation. Within the FID framework and functional areas associated with joint strategic capabilities planning, CA forces—

- Perform specific planning tasks in support of the Services and combatant commands.
- Identify civil considerations.
- Execute assessments.
- Coordinate internally and with the HN.

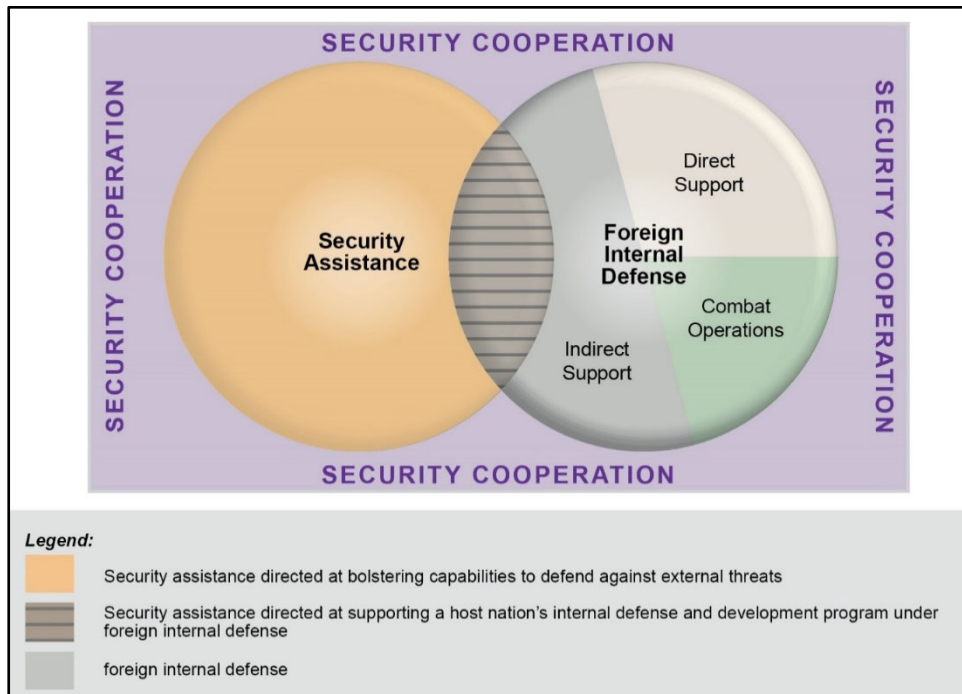


Figure 5-3. Security assistance and foreign internal defense

- 5-68. CAO are vital to theater FID operations in areas from planning to execution. It is a valuable resource in—
- Planning and facilitating the conduct of various indirect, direct support (not involving combat operations), and combat operations in support of the overall FID effort.
 - Supporting the reconstitution of viable and competent civil infrastructure in the operational areas that were previously ungoverned, under-governed, or in the direct control of threat forces or shadow governments.
- 5-69. Through CAO, CA forces also assist the government by executing SCA.
- 5-70. The CA forces supporting FID range from staffs to CATs. Essential tasks performed may include—
- Incorporating CAO in all activities related to FID (from planning to execution).
 - Reviewing and supporting host-nation internal defense and development goals.
 - Ensuring host-nation public support, from local to national levels.
 - Establishing and maintaining contact with nonmilitary agencies and local authorities.
 - Ensuring the relevant parties always maintain host-nation sovereignty.
 - Advocating for host-nation self-sufficiency.

Note: JP 3-05, JP 3-22, JP 3-57, FM 3-18, and ATP 3-05.2 provide more information on FID.

COUNTERINSURGENCY

5-71. Insurgencies exist apart from, before, during, or after a conventional conflict. Elements of a population often grow dissatisfied with the status quo. When a population or groups in a population are willing to fight to change the conditions to their favor, using both violent and nonviolent means to affect a change in the prevailing authority, they often initiate an insurgency. Ideally, the host country is the primary actor in defeating an insurgency. Even in an insurgency that occurs in a country with a nonfunctioning central government, or after a major conflict, the host country must eventually provide a solution that is culturally acceptable to its society and meets U.S. policy goals.

5-72. The U.S. uses a range of methods to aid a partner nation in defeating an insurgency. Effective counterinsurgency operations require—

- Understanding of the military profession, civil factors, capabilities, and vulnerabilities.
- Execution of and challenges to governance.
- Societal understanding.
- Cultural knowledge.

5-73. The tasks that counterinsurgents perform in countering an insurgency are not unique. It is the organization of these tasks in time and space that is unique. Although all tasks executed to establish the conditions to reach a desired end state are significant, stability operations may be critical in a counterinsurgency.

5-74. By definition, counterinsurgencies occur in the civil component. As such, a civil component solution is the most effective deterrent to counterinsurgencies. Insurgencies are most readily defeated locally by local actors. Civil networks provide the commander a partner in the civil component to identify and defeat insurgent threats with minimal use of U.S. military resources while also utilizing a local partner. SCA missions allow CA forces to reinforce the stability, security, and effective governance needed to choke out insurgent support. Effective governance meets the needs of the population and provides security.

5-75. Entities best qualified to accomplish nonmilitary tasks may not always be available. In such cases, military forces may need to perform those tasks until civilian-led capabilities become available. Within the Army, CA is the branch ideally organized, trained, and equipped to assist in these functions. CA forces are also ideally suited to interact with the population to determine the root causes of instability and improving the relationship between the populace and the HN. CAO, in counterinsurgency, should focus on the following tasks:

- Planning and conducting CR, CE, and CND to determine causes of instability.
- Providing SCA, as required, to bolster host-nation government capability or capacity.
- Building and/or mobilizing civil networks to support stable governance.

- Conducting transitional military authority until the host-nation government has the capacity to conduct required governance activities.
- Improving host-nation legitimacy through activities such as military civil action.
- Developing, planning, and executing projects that address the humanitarian needs of the populace.
- Providing CAO and CMO training to host-nation and partner security forces and civilian agencies.
- Providing coordination and liaison between the IPI, interagency, and civil component to support unified action.
- Conducting activities with host-nation authorities, interagency, international organizations, NGO, private sector, or international military partners to deny support to the insurgents.

Note: JP 3-24 provides additional information on counterinsurgency.

This page intentionally left blank.

Appendix A

History of Civil Affairs

The history of U.S. Army CA—known as Military Government prior to 1959—can best be described as one of continuous evolution. From its ad hoc origins in the immediate aftermath of World War I, the Army professionalized CA as a reserve branch (1955) and a regular Army branch (2006). This brief history provides a short overview of U.S. Army CA. While it highlights critical events, it is not comprehensive.

A-1. Since its creation in the early Republic, the U.S. Army conducted roles and functions similar to CA (Military Government). Examples include the Lewis and Clark Expedition (1804 to 1806), Major General Winfield Scott’s occupation of Mexico City (1847 to 1848), post-Civil War Reconstruction in the American South (1865 to 1877), and the Philippine-American War (1899 to 1913).

A-2. During the Civil War, the Army implemented *General Orders No. 100 (1863)*, otherwise known as the Lieber Code. It provided the U.S. Army with guidelines that regulated the just treatment of civilians and property in the occupied South. Post-war, *General Orders No. 100* served as the foundation for the development of laws dictating how the U.S. Army operated in occupied territory. The U.S. Army codified these laws in the *Rules of Land Warfare (1914)*, later revised as FM 27-10, then FM 6-27. As important as the Lieber Code was, it was just another step toward developing formal CA (Military Government) structure, doctrine, and training.

Note: FM 27-10 is an obsolete publication, which provides historical reference and is listed in the Obsolete Publications section of the references for this FM.

A-3. The true beginning of modern U.S. Army CA was the post-World War I occupation of the German Rhineland by the Third U.S. Army from December 1918 until 11 July 1923. The lessons from this experience led the Army to develop CA doctrine, provide professional education, and eventually create specialized CA (Military Government) units. In the words of Major Truman Smith, the main author of the final report on the occupation, the Army’s post-World War I actions “lacked both training and organization to guide the destinies of nearly 1,000,000 civilians whom the fortunes of war had placed under its temporary sovereignty.” While it lasted, the U.S. Army occupation performed civil administration tasks and ensured that Germany would not resume hostilities. A new experience for the modern Army, it left such an impact that it led to the creation of a formal CA capability.

A-4. For CA, the most important development was the subsequent publication of *American Military Government of Occupied Germany, 1918–1920: Report of the Officer in Charge of Civil Affairs, Third Army and American Forces in Germany*. Known as the Hunt Report after its director, Colonel Irvin L. Hunt, it provided analyses of the Army’s experience, highlighting the lack of formal CA training. This groundbreaking official study, which published the experiences of American Soldiers who occupied Germany, drove change.

A-5. The Hunt Report and similar, but less widely distributed, studies of Army involvement in the Philippines pointed to requirements for a standing CA staff section for incorporating CA in war planning. This led to the publication of an updated *Rules of Land Warfare* in 1934 that contained a section on military government and established the need for a CA (Military Government) capability. Based on these sources, in 1940, the Army published its first doctrine that focused on these special skills, FM 27-5, which guided U.S. Army CA (Military Government) efforts throughout World War II. Further study of the Hunt Report and the new doctrinal publications led to the creation of the first formal U.S. Army CA training program—the School of Military Government—at the University of Virginia in May 1942.

Note: FM 27-5 is an obsolete publication, which provides historical reference and is listed in the Obsolete Publications section of the references for this FM.

A-6. The school instructed officers in staff-level military government functions. However, because the School of Military Government could not meet the growing demand for trained CA personnel, the Army exported the program to other civilian universities throughout the U.S. By 1945, the Army taught CA courses at Fort Custer, Michigan; the CA Staging Area at Fort Ord/Presidio of Monterey, California; or in overseas schools.

A-7. To manage its CA (Military Government) efforts, the U.S. Army created the Military Government Division, established in July 1942 under the Office of the Provost Marshal General. Its small size and lack of influence, compounded by the sheer number of CA matters experienced by Lieutenant General Dwight D. Eisenhower after the invasion of North Africa on 8 November 1942, prompted the formation of the CA Division under the War Department in March 1943. Led by Major General John H. Hilldring, the CA Division formulated policy for CA (Military Government) units. These units ranged in size from the European CA Division, with more than 8,200 personnel, to nine-person CA Detachments spread throughout combat units.

A-8. These elements worked closely, near, or with combat forces, helping to address the concerns of civilian populations and stabilizing rear areas so that combat commanders could remain focused on the enemy. CA (Military Government) elements had expanded roles in the final year of World War II and particularly in stabilizing post-war Germany, Austria, Italy, Japan, and Korea. However, the number of CA personnel declined considerably as the Army reduced force structure in the postwar drawdown. A standing CA capability appeared to be on its way out of the Army until another conflict guaranteed its survival as a permanent U.S. Army capability.

A-9. The Korean War not only resurrected U.S. Army CA, but also served as a turning point for the employment of CA and led to a permanent establishment of the capability in the U.S. Army. With the brief exception of conducting military government in North Korea in late 1950, U.S. CA personnel worked in South Korea, a sovereign allied country with a functioning government. There, CA Soldiers, organized first under the United Nations Public Health and Welfare Detachment (1950), then the United Nations Civil Assistance Command (1951 to 1953), and later, under the Korean Civil Assistance Command (1953 to 1955). CA Soldiers provided refugee assistance and medical care for the civilian population, while helping to rebuild destroyed public infrastructure. The large-scale effort provided the rationale for the U.S. Army to establish the CA (Military Government) Branch in the USAR on 17 August 1955. On 2 October 1959, the Army eliminated the term Military Government and renamed it the CA Branch. This name change reflected recent operations and changes in doctrine describing how the U.S. Army would employ CA in future conflicts.

A-10. Similar to the Korean War, the U.S. Army CA effort in South Vietnam (1965 to 1971) was based on operating within a sovereign allied country. However, this time, as guided by FM 41-10, CA became associated with unconventional warfare (UW). The three active duty CA companies—the 41st, 2d, and 29th—assigned to South Vietnam helped integrate rural and war refugee populations into the national economic and political systems. The CA companies provided medical care and assisted with agricultural, educational, and infrastructure improvements, while giving credit to the government of South Vietnam for their efforts. That mission would be later reincarnated as village stability operations in Afghanistan in 2010 to 2014.

Note: FM 41-10 is an obsolete publication, which provides historical reference and is listed in the Obsolete Publications section of the references for this FM.

A-11. The experience in Vietnam brought lasting changes to CA. On 15 September 1971, the CA School, then administered under the Provost Marshal General's Office and based at Fort Gordon, Georgia, moved to Fort Bragg, North Carolina. There, it came under the direction of the U.S. Army Institute for Military Assistance, now the United States Army John F. Kennedy Special Warfare Center and School (USAJFKSWCS). Active duty CA units soon relocated to Fort Bragg and were placed under the 95th CA Group. However, in the post-Vietnam drawdown, the Army disbanded most active duty CA units. Only the 96th CA Battalion at Fort Bragg remained on active duty. Then, as now, the preponderance of CA units resided in the USAR.

A-12. During the next two decades, CA made incremental steps toward becoming a core element of U.S. Army Special Operations. On 1 October 1982, the Army established 1st Special Operations Command (SOCOM) at Fort Bragg in which the 96th CA Battalion was a subordinate element. After the U.S. Army

created the United States Army Special Operations Command (USASOC) at Fort Bragg on 1 December 1989, the 96th CA Battalion remained under 1st SOCOM. All reserve CA units based in the contiguous U.S. were assigned to the United States Army Reserve Special Operations Command (USARSOC), which became the U.S. Army Civil Affairs and Psychological Operations Command (USACAPOC) on 27 November 1990. Subordinated under USASOC, this placed the command and control of all contiguous U.S.-based active duty (96th CA Battalion) and the USAR CA and PSYOP units under a single headquarters. On 3 March 1993, Secretary of Defense Leslie 'Les' Aspin formally designated active and reserve CA units in the contiguous U.S. as Army Special Operations Forces (ARSOF). The reserve formation based outside the contiguous U.S., the 322d CA Brigade in Hawaii, was not designated as ARSOF.

A-13. These organizational changes coincided with the Army's increased use of CA units following the breakup of the Soviet Union in 1991 and subsequent global instability. USASOC routinely deployed CA forces to assist in all phases of operations—including supporting peacekeeping, disaster relief, counterinsurgency, combat, and stability efforts. Reserve CA units, namely the 352d CA Command, spearheaded the Kuwaiti Task Force and its efforts to stabilize Kuwait following the expulsion of the Iraqi invaders in February 1991. Other USAR CA units and the 96th CA Battalion provided CA support in Iraq for Operation DESERT SHIELD/STORM and for Operation PROVIDE COMFORT, the post-war humanitarian mission to assist the Kurds. Other notable deployments for CA units include peacekeeping and disaster relief efforts in Operation RESTORE HOPE in Somalia, Operation UPHOLD DEMOCRACY in Haiti, and Operation JOINT ENDEAVOR in the Balkans. However, the 11 September 2001 terrorist attack on the United States ushered CA into a new era.

A-14. Significant changes for CA took place during the Global War on Terror. To meet the growing needs of the conventional force, on 1 October 2006, the Army reassigned USACAPOC from USASOC to USAR. USASOC retained the single Active Duty special operations CA unit, the 96th CA Battalion. Two weeks later, on 16 October 2006, the Army established CA as a branch in the regular Army. Prior to that, it had been a functional area. Constant rotations to Afghanistan and Iraq accelerated the operating tempo of CA units and promoted growth in the active force. USASOC used 96th CA Battalion personnel as cadre to create four additional active special operations CA Battalions (91st, 92d, 97th, and 98th) under the newly organized 95th CA Brigade (2007). Currently, the 95th CA Brigade (Special Operations) (Airborne) is assigned to the 1st Special Forces Command supporting ARSOF and USSOCOM commitments.

A-15. The demand to support continued Global War on Terror operations also resulted in the creation of the conventional 85th CA Brigade on 16 September 2011, with five subordinate battalions (80th, 81st, 82d, 83d, and 84th). Based at Fort Hood, Texas, this regular Army unit was subordinated to United States Army Forces Command (FORSCOM) and provided CA support to conventional forces. However, following troop level drawdowns, the Army deactivated the 80th and 84th CA battalions on 15 September 2016. The 85th CA Brigade, along with its 81st and 82d battalions were inactivated on 15 March 2018, leaving the 83d CA Battalion as the sole active CA unit supporting the conventional force.

A-16. Army CA has evolved considerably since its origins in the post-World War I occupation of Germany. The Army has recognized the continuing need for formal CA instruction and planning and the requirement for a standing CA force. CA engages across the range of military operations—from the prevention of hostilities to assisting people in returning to daily life after hostilities or humanitarian crises end. The demand for CA is strong because it is a force multiplier and has a history of proven utility.

This page intentionally left blank.

Appendix B

Civil Affairs Government Function Expertise

This appendix describes the role of CA Soldiers as government technical sector experts, known as government function specialists. This expertise is essential to CA fulfillment of its role of engaging and leveraging the civil component of the OE while enhancing, enabling, or providing governance.

PROVIDING GOVERNMENT EXPERTISE - FUNCTIONAL SPECIALTY AREAS

B-1. The CA military government function expertise capability is organized around five functional specialty areas based on the five USG stability sectors. These functional specialty areas are:

- **Civil Security.** The CA civil security functional specialty area is concerned with civil security and public order that generates the foundational conditions for stability within the OE. This relates to the development and administration of policies, planning mechanisms, and training of partner nation public officials to respond to threats and hazards (human-made, natural, internal and external) across all levels of government. When required, the capabilities within this functional specialty area assist in the establishment and maintenance of a transitional military authority.
- **Civil Control.** The CA civil control functional specialty area is concerned with the administration of legal systems and institutions for the application of civil and criminal laws within the civil component of the OE. When required, the capabilities within this functional specialty area assist in the establishment and maintenance of a transitional military authority.
- **Essential Services.** The essential services functional specialty area is concerned with activities designed for the provision of basic needs and services (water, food, shelter, sanitation, and health services), as well as those that facilitate the restoration of a social fabric and community life, the systems and institutions for the provision of primary and secondary education, and the return or voluntary resettlement of those displaced. When required, the capabilities within this functional specialty area assist in the establishment and maintenance of a transitional military authority.
- **Governance Support.** The governance and participation functional specialty area is concerned with public administration, cultural relations, public information, and environmental management. Collectively, these programs, policies, systems and institutions enable a state's ability to serve the citizenry, articulate interests, manage resources, and exercise bestowed power in a society. These same programs, policies, systems, and institutions confer participation and the individual and collective citizenry's ability to share, access, or compete for power through nonviolent political processes, and to enjoy the collective benefits and services of the nation. When required, the capabilities within this functional specialty area assist in the establishment and maintenance of a transitional military authority.
- **Economic Stabilization and Infrastructure.** The economic stabilization and infrastructure functional area is concerned with foundational commerce, monetary, fiscal labor issues; agriculture, utilities, and public works; communications systems; and transportation fields. Collectively, these programs, policies, systems, and institutions constitute an economic system. The economic system is the intersection of government institutions and activities, corporate and private enterprises, and populations, and the mobilization of resources for the production and distribution of goods and services, which are integral to the stability of a region or society. When required, the capabilities within this functional specialty area assist in the establishment and maintenance of a transitional military authority.

FUNCTIONAL SPECIALTY FOCUS AREAS

B-2. Each functional specialty area has one or more focus areas nested within it, as shown and discussed in Chapter 2 of this FM. Not all focus areas are provided solely by the CA government function specialists (that is, public administration expertise resides with CA officers and noncommissioned officers, while corrections could be provided by military police). The 16 CA functional specialty focus areas are described below.

LAW AND BORDER ENFORCEMENT

B-3. The law and border enforcement functional specialty places emphasis on indigenous ministerial and sub-ministerial responses required to enforce laws and secure national borders. Application of the technical expertise of this functional specialty team delivers assessments, analysis, and evaluation, which allow for the provision of advice, guidance, and access to additional resources. This augmentation to those institutions enhances capability of those institutions to implement and conduct assessments and oversight, provide and regulate policies and programs, and operate institutional systems and agencies from national to local levels.

B-4. This enhanced capability provides for the structuring, resourcing, organizing, rehabilitation, and implementation of the curriculum, facilities, technology, processes, and personnel development required to implement and sustain the activities for the maintenance of public order. These activities ensure the enforcement of the rule of law through authenticity, safe-guarding, preserving documentation, cataloging and accounting, accessibility, and transparency of the actions and interactions required of public law and border enforcement agents. Law and border enforcement efforts have inherent crosscutting effects upon, and requirements of, the other functional areas. This functional specialty team is prepared to assume administrative and supervisory roles of the national and subnational institutions, as required by conditions of the OE.

RULE OF LAW

B-5. The rule of law functional specialty places emphasis on the judiciary systems of the national and subnational governments that incorporate customary indigenous methods with internationally acceptable standards. Application of the technical expertise of this functional specialty team delivers assessments, analysis, and evaluation, which allow for the provision of advice, guidance, and access to additional resources. This augmentation to indigenous institutions enhances the capability of those institutions to implement and conduct assessments and oversight, provide policies and programs, and operate institutional systems and agencies from national to local levels.

B-6. This enhanced capability provides development for the structuring, resourcing, organizing, rehabilitation, and implementation of the requisite curriculum, facilities, processes, and personnel development required to implement and sustain the rule of law. This functional specialty team is prepared to assume administrative and supervisory roles of the national and subnational institutions, as required by conditions of the OE. Additional advice and expertise is also resident with this team to support war crime courts and tribunals, and the establishment and administration of truth commissions.

CORRECTIONS

B-7. The corrections functional specialty places emphasis on the role of the national and subnational governments in fulfilling the punitive phase of the rule of law through a transparent correctional system that conveys safe and humane detention, incarceration, rehabilitation, and reintegration of qualified prisoners. Application of the technical expertise of this functional specialty team delivers assessments, analysis, and evaluation, which allows for the provision of advice, guidance, and access to additional resources. This augmentation to indigenous institutions enhances the capability of those institutions to conduct assessments, implement oversight, provide policies and programs, and operate institutional systems and agencies at national to local levels.

B-8. This enhanced capability provides for the structuring, resourcing, organizing, rehabilitation, and implementation of the curriculum, facilities, processes, and personnel development required to implement and sustain a correctional system. This functional specialty team is prepared to assume administrative and supervisory roles of the national and subnational institutions, as required by conditions of the OE.

PUBLIC SAFETY

B-9. The public safety functional specialty advises and assists in (or reestablishes) the evaluation, assessment, planning, and implementation of systems and programs that establish civil security sector assistance, or emergency management administration, and planning assistance. They promote community resilience through application of the prevention and resolution framework, and planning for the mitigation of effects of human-made or natural disasters for the maintenance of public order. This section consists of teams educated and experienced in emergency management, policing, and community relations.

PUBLIC EDUCATION

B-10. The public education functional specialty team is concerned with the structure and conduct of the formal education system of indigenous institutions, any competing system, and their collective impacts upon stability across the OE. Application of the technical expertise of this functional specialty team delivers assessments, analysis, and evaluation that permits this team to provide advice and guidance access to additional resources. This augmentation to indigenous institutions enhances the capability of those institutions to conduct assessments, implement oversight, provide policies and programs, and operate institutional systems and agencies at national to local levels.

B-11. This enhanced capability provides for the structuring, resourcing, organizing, rehabilitation, and implementation of the curriculum, facilities, processes, and personnel development required to implement and sustain inclusive public education. With consideration toward equitable accessibility by individuals, institutions, and the private sector, these activities position communities for reestablishment of stability. These efforts have inherent crosscutting effects upon, and requirements of, the other functional areas. This functional specialty team is prepared to assume the administrative and supervisory roles of the national and subnational institutions, as required by conditions of the OE.

PUBLIC HEALTH

B-12. The public health functional specialty advises and assists commanders, interagency, and host-nation representatives in matters pertaining to the vulnerabilities and strengths of indigenous health care institutions through the data collection, analysis, evaluation, legislation, regulation, and/or policy guidance. If necessary, the public health functional specialty also reestablishes the administration of health care institutions and programs at the national, regional, and provincial levels. With consideration toward equitable accessibility by individuals, institutions, and the private sector, these activities position communities for reestablishment of stability. These efforts have inherent crosscutting effects upon, and requirements of, the other functional areas. This functional specialty team is prepared to assume the administrative and supervisory roles of the national and subnational institutions, as required by conditions of the OE.

CIVILIAN SUPPLY

B-13. The civilian supply functional specialty is concerned with the response mechanism of indigenous institutions in reaction to a crisis through surveying, assessing, and conducting a resources analysis and evaluation of the local area. Results are used to determine the status of the essential needs of the indigenous population. This helps determine the type and amount of resources available, and the location and application of solution sets. Civilian needs that cannot be met with reallocated indigenous resources are then assessed and requested to integrate the donor-sourced resources of NGOs or international organizations, or U.S. military resources—including Class X supplies. An additional competency of this team is development of civil authorities available to collect and distribute supplies or provide statistical analysis and operational oversight as a response to refugees and displaced persons. This functional specialty team is prepared to assume the administrative and supervisory roles of the national and subnational institutions, as required by conditions of the OE. In doing so, the team identifies supplies and resources that can be diverted for U.S. military use and identifies any associated negative impacts upon the civil component of the OE.

PUBLIC ADMINISTRATION

B-14. The public administration functional specialty places emphasis on the structure and conduct of the indigenous government from national to local levels. Through assessments, analysis, and evaluation, this

functional specialty team provides advice and guidance access to additional resources to augment the nationwide network of indigenous civil authorities to promote oversight and assessing, advising, improving, or establishing legislative and executive institutions from national to local levels; and the processes of these institutions in the administration of governance. Considerations for the public administration functional specialty include political parties, eligibility for franchise, elections, tenure, civil servant service, policy and programming, and all other aspects of the development and operation of the apparatus of government. These activities enable the interconnectivity of individuals, civil society, and institutions to produce coordinated, integrated, and synchronized efforts toward stability. These efforts have inherent crosscutting effects upon, and requirements of, the other functional areas. This functional specialty team is prepared to assume the administrative and supervisory roles of the national and subnational institutions, as required by conditions of the OE.

PUBLIC INFORMATION

B-15. The public information functional specialty places emphasis on the ability of the indigenous government to be transparent, accountable, informative, and effective in communicating to the citizenry. Application of the technical expertise of this functional specialty team delivers assessments, analysis, and evaluation that permits this team to provide advice and guidance access to additional resources. This augmentation to indigenous institutions enhances the capability of those institutions to conduct assessments, implement oversight, provide policies and programs, and operate public information systems and agencies from national to local levels.

B-16. This enhanced capability provides for the structuring, resourcing, organizing, rehabilitation, and implementation of the curriculum, facilities, processes, and personnel required to develop and execute public relations and information dissemination activities. These activities include support to the political and electoral processes, emergency management actions, societal participation in issues, respect of dissenting views, independence of private and international media, communication of policy and development objectives, and the provision of equitable accessibility by individuals, institutions and the private sector. Public information efforts have inherent crosscutting effects upon, and requirements of, the other functional areas. This functional specialty team is prepared to assume the administrative and supervisory roles of the national and subnational institutions, as required by conditions of the OE.

CULTURAL RELATIONS

B-17. The cultural relations functional specialty places emphasis on the stewardship of the social and cultural resources, official public records, and archives of the state. This functional specialty also places emphasis on the educated expertise, and the focused understanding of traditional culture, customs, and arts of an area of a nation, or region. Application of the technical expertise of this functional specialty team delivers assessments and analysis, which allow for the provision of advice, guidance, and access to additional resources. This augmentation to indigenous institutions enhances the capability of those institutions to conduct assessments, implement oversight, provide and regulate policies and programs, and operate institutional systems and agencies at national to local levels.

B-18. This enhanced capability provides for the structuring, resourcing, organizing, rehabilitation, and implementation of the curriculum, facilities, processes, and personnel development required to implement and sustain the activities for the administration of public records, archives, and cultural assets. These activities ensure the authenticity, safe-guarding, preservation and restoration, cataloging and accounting, accessibility, and transparency of public documents, heritage, and properties. With consideration toward equitable accessibility by individuals, institutions, and the private sector, these activities position communities for reestablishment of stability. These efforts have inherent crosscutting effects upon, and requirements of, the other functional areas. This functional specialty team is prepared to assume administrative and supervisory roles of the national and subnational institutions, as required by conditions of the OE.

ENVIRONMENTAL MANAGEMENT

B-19. The environmental management functional specialty places emphasis on the principles of protection and conservation of the natural resources and mitigation of hazards or pollution as it concerns the state, while fostering supportable access, development, and utilization. Through the application of technical skills, functional specialists advise and assist in rehabilitating, establishing, delivering, and maintaining government environmental management agencies and systems and their associated requisite plans, policies, and procedures

while supporting the integration of the efforts of individuals, civil society organizations, NGOs, international organizations, and other U.S. assistance and resources. With consideration toward equitable accessibility by individuals, institutions, and the private sector, these activities position communities for reestablishment or preservation of stability. These efforts have inherent crosscutting effects upon, and requirements of, the other functional areas. This functional specialty team is prepared to assume the administrative and supervisory roles of the national and subnational institutions, as required by conditions of the OE.

ECONOMIC DEVELOPMENT

B-20. The economic development functional specialty places emphasis on the existing national to localized economic network, any competing system, and their collective impacts upon stability within the OE. Through assessments, analysis, and evaluation, this functional specialty team provides advice and guidance access to additional resources to augment the national network to develop, implement, regulate, and enforce interstate and international policies and programs focused upon macroeconomics, market(s) development, and microeconomics. These activities enable the interconnectivity of individuals, civil society, and institutions to produce coordinated, integrated, and synchronized efforts. These efforts have inherent crosscutting affects upon, and requirements of, the other functional areas. This functional specialty team is prepared to assume the administrative and supervisory roles of the national and subnational institutions, as required by conditions of the OE.

FOOD AND AGRICULTURE

B-21. The food and agriculture functional specialty places emphasis on the indigenous, national through local agriculture systems, agencies, services, personnel, methods, resources, institutions, and facilities. These include any competing systems and their collective impacts upon conditions of the OE and effects on stability. Application of the technical expertise of this functional specialty team delivers assessments, analysis, and evaluation, which allow for the provision of advice, guidance, and access to additional resources. This augmentation to the indigenous institutions enhances the capability of those institutions to conduct assessments and implement oversight, provide and regulate policies and programs, and operate systems and agencies at the national to local levels.

B-22. This enhanced capability provides for the structuring, resourcing, organizing, rehabilitation, and implementation of the curriculum and education, facilities, technology, processes, and personnel development required to implement and sustain food and agriculture activities. These activities include the production, processing, storage, product safety, marketing, and distribution of foodstuffs, food by-products, and fiber and wood products. With consideration toward equitable access by individuals, institutions, and the private sector, these activities position communities for the continuation, or establishment, of stability. These efforts have inherent crosscutting effects upon, and requirements of, the other functional specialties. This functional specialty team is prepared to assume the administrative and supervisory roles of the national and subnational institutions, as required by conditions of the OE.

PUBLIC WORKS AND UTILITIES

B-23. The public works and utilities functional specialty places emphasis on the national to localized public facilities and utilities network as it exists within the OE. Through assessments, analysis, and evaluation, this functional specialty team provides advice and guidance access to additional resources aimed to enhance these networks. This includes the ability and capabilities to develop, implement, regulate, and enforce policies and programming for essential services. With consideration toward equitable accessibility by individuals, institutions, and the private sector, these activities position communities for continuation, or establishment, of stability. These efforts have inherent crosscutting effects upon, and requirements of, the other functional areas. This functional specialty team is prepared to assume the administrative and supervisory roles of the national and subnational institutions, as required by conditions of the OE.

PUBLIC COMMUNICATIONS

B-24. The public communications functional specialty places emphasis on the national communications network as it exists within the OE. Through assessments, analysis, and evaluation, this functional specialty team

provides advice and guidance access to additional resources aimed to enhance the national network to develop, implement, regulate, and enforce interstate and international policies for communications by radio, television, wire, wireless, satellite, cable, and postal means. These activities enable the interconnectivity of individuals, civil society, and institutions to produce coordinated, integrated, and synchronized efforts. These efforts have inherent crosscutting effects upon, and requirements of, the other functional specialty areas. This functional specialty team is prepared to assume the administrative and supervisory roles of the national and subnational institutions, as required by conditions of the OE.

PUBLIC TRANSPORTATION

B-25. The public transportation functional specialty places emphasis on the national transportation network as it exists within the OE. Through assessments, analysis, and evaluation, this functional specialty team provides advice and guidance access to additional resources aimed to enhance the national network to develop, implement, regulate, and enforce interstate and international policies for the physical movement of commerce and people across ground, water, and through air conveyances. These activities enable the interconnectivity of individuals; civil society; and associated organizations, institutions, and the private sector. These efforts have inherent crosscutting effects upon, and requirements of, the other functional specialties. This functional specialty team is prepared to assume the administrative and supervisory roles of the national and subnational institutions, as required by conditions of the OE.

Appendix C

Civil Affairs in Special Operations

This appendix describes the contribution of CA forces to special operations. CA forces can support all special operations, such as UW, direct action, special reconnaissance, counterterrorism, and countering weapons of mass destruction. This appendix also describes the USSOCOM CME program.

OVERVIEW

C-1. CAO are conducted within conventional and special operations missions. The difference between the two is that CA special operations are generally conducted in hostile, denied, or politically sensitive environments utilizing specialized tactics, techniques, and procedures. CA special operations are conducted alongside other SOF from across the DOD, and in support of DOS priorities in embassies around the world.

C-2. Given the environments in which special operations are conducted, CA forces conducting those missions are at a greater risk for isolation than conventional forces. This greater risk necessitates extended training on small unit tactics, tactical movement, survival, evasion, resistance, escape, and other techniques that are unique to special operations.

UNCONVENTIONAL WARFARE

C-3. The DOD defines *unconventional warfare* as activities conducted to enable a resistance movement or insurgency to coerce, disrupt, or overthrow a government or occupying power by operating through or with an underground, auxiliary, and guerrilla force in a denied area (JP 3-05). UW is a core activity of ARSOF, and has strategic utility to alter the balance of power between sovereign states.

C-4. CA forces support UW through the execution of CAO, which is critical to the planning and execution of UW campaigns. When integrated throughout all phases of UW planning and execution, CA forces provide the capability to analyze the strengths, capabilities, and vulnerabilities of the civil component, as applicable, to both the existing regime and the resistance movement. CAO also provide a comprehensive approach toward assisting the resistance in legitimacy and TG, from the initial resistance movement, through transition, to an emergent stable government. CA forces also are able to assist in developing broader governance efforts in support of the resistance.

C-5. CA forces are typically sought for their unique capabilities with regards to identifying and mitigating the underlying causes of instability in order to create a stable environment. This same analysis, however, can be utilized by the resistance to identify and degrade those identified strengths and bonds of the existing regime into vulnerabilities, resulting in its continued delegitimization. This creates legitimacy opportunities for the movement.

C-6. Separately, within their sphere of control and influence, the resistance can consolidate gains in public support and initial governance capacity by utilizing CA assessments, strengthening civil vulnerabilities, and cementing a bond with the greater population. Methods to realign the legitimacy of power should consider the timeliness required to restore essential services and strengthen the bonds between the population and the resistance movement (or new government) upon the collapse of the old regime.

C-7. Through CNDE and SCA, CA forces can support an underground, auxiliary, or government-in-exile to plan for and administer civil government in the areas of rule of law, economic stability, infrastructure, governance, public health and welfare, and public education and information. SCA is the systematic application of specialized skills for assessing and advising on the development of stability and governance. When conducting CR and CE to develop civil consideration data, ARSOF CA forces collaborate with CA

military government specialists within USAR CA formations to formulate governance and stability lines of effort for the resistance.

C-8. The resistance gains legitimacy through TG via support to its alternate administration. This is accomplished by addressing grievances and providing essential services to create a civil strength or bond with the population. As the regime becomes severely degraded or collapses, CA will assist with addressing the remaining civil vulnerabilities to create stability for the emergent government, and inclusively, across the indigenous population.

C-9. It is critical to note that CAO support to UW, is not intended to represent a linear process. As depicted in figure C-1, it represents the relationship between civil strengths and civil vulnerabilities as they pertain to civil instability for the current regime, civil opportunities for the resistance, and stability for a new government. The left side depicts CAO and corresponding resistance actions that increase the delegitimization of the current regime, through degradation of civil strengths with the population, and attacking civil vulnerabilities to provide legitimacy opportunities for the resistance.

Note: DODD 3000.07, JP 3-05, FM 3-05, FM 3-18, ATP 3-05.1, and ATP 3-18.1 provide more information on UW.

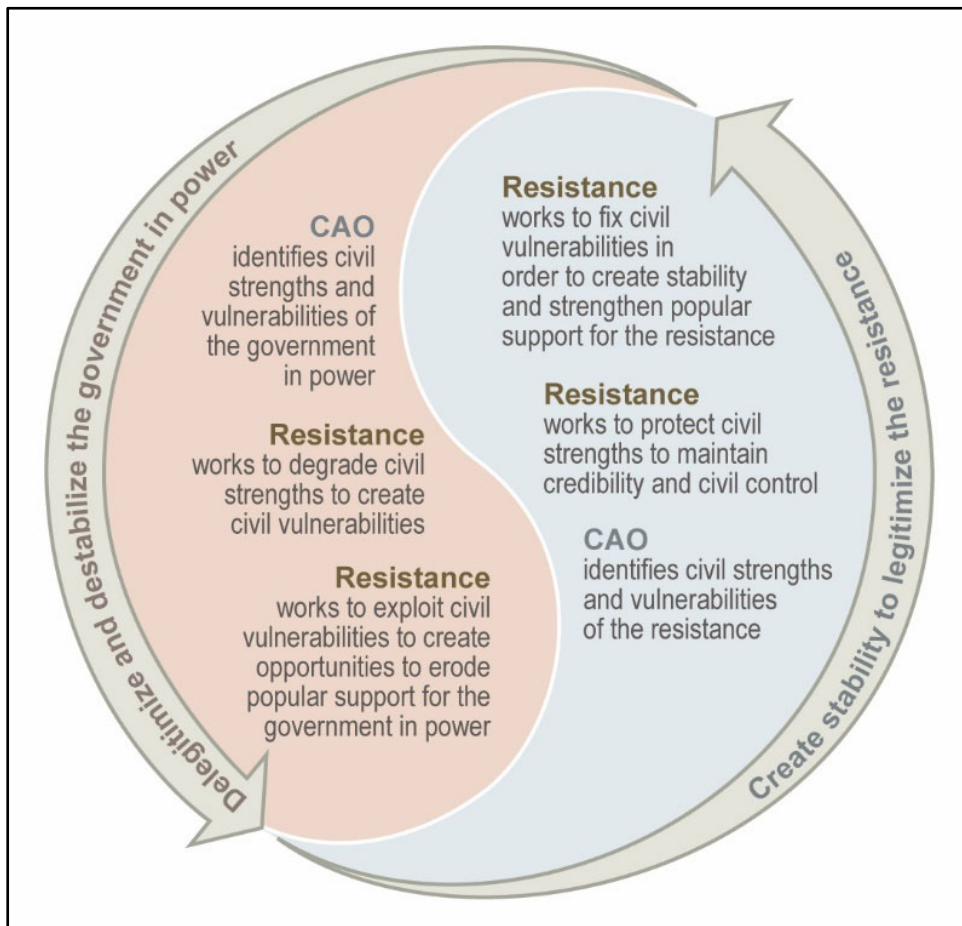


Figure C-1. Civil Affairs operations in unconventional warfare

DIRECT ACTION

C-10. Direct action is a core activity of ARSOF consisting of short-duration strikes and other small-scale offensive actions conducted by select ARSOF elements as a special operation in hostile, denied, or

diplomatically sensitive environments, which employs specialized military capabilities to seize, destroy, capture, exploit, recover, or damage designated targets. Direct action differs from conventional offensive actions in the level of physical and political risk, operational techniques, and the degree of discriminate and precise use of force to achieve specific objectives.

C-11. CA forces do not conduct direct action missions; however, CA forces conduct CR and CE to gain shared understanding of the civil component to address possible adverse effects of direct action and to mitigate those effects through civil network engagement and civil considerations analysis. CAO planning support to direct action may include—

- Gaining civil information to develop the civil component of the common operational picture of the commander.
- Providing civil component analysis to planning processes.
- Providing civil component analysis toward the identification of—
 - Critical links and nodes.
 - Decisive points.
 - Centers of gravity.
- Advising on the presence and potential of culturally, economically, and politically significant assets and resources within the objective area.
- Participating in the targeting process by nominating restrictive-fire areas and no-fire areas to minimize unnecessary damage to the civil infrastructure and culturally sensitive sites.
- Evaluating damage to infrastructure and other combat-related effects to the civil component.
- Providing post-strike employment options for CA capabilities.

Note: JP 3-05 and ATP 3-18.3 provide additional information on direct action.

SPECIAL RECONNAISSANCE

C-12. Special reconnaissance is a core activity of ARSOF consisting of reconnaissance and surveillance actions conducted by select ARSOF elements as a special operation in hostile, denied, or diplomatically and/or politically sensitive environments to collect or verify information of strategic or operational significance, which employs military capabilities not normally found in conventional forces. CA forces do not conduct special reconnaissance missions. However, CA forces conduct CND, CR, and CE to gain shared understanding of the civil component to inform the planning effort for special reconnaissance missions. CAO planning support to special reconnaissance may include—

- Engaging civil networks that have access to denied or sensitive areas.
- Gaining civil information to develop the civil component of the common operational picture of the supported commander.
- Providing civil component analysis to planning processes.
- Advising on the presence of culturally, economically, and politically significant assets and resources within the objective area.

Note: FM 3-05 and ATP 3-18.4 provide additional information on special reconnaissance.

COUNTERTERRORISM

C-13. *Counterterrorism* consists of activities and operations taken to neutralize terrorists and their organizations and networks in order to render them incapable of using violence to instill fear and coerce governments or societies to achieve their goals (JP 3-26). Counterterrorism actions include strikes and raids against terrorist organizations and facilities outside the U.S. and its territories.

C-14. CA forces combat terrorism efforts indirectly through activities to defeat the ideologies or motivations that spawn terrorism. Counterterrorism is usually attributed to direct action specifically against terrorists or violent extremist organizations. CAO planning support to counterterrorism action may include—

- Identifying TSOC objectives and developing nonlethal activities that support them.
- Identifying CCDR objectives and developing nonlethal activities that support them.
- Identifying the ambassador or country team objectives and developing nonlethal activities that support them.
- Gaining civil information through CR, CE, and CND to develop the civil component of the common operational picture of the supported commander.
- Providing civil component analysis toward the identification of—
 - Centers of gravity.
 - Decisive points.
 - Critical links and nodes.
- Denying the enemy civil component resources.
- Recommending post-strike employment options for CA capabilities.
- Participating in the targeting process to minimize unnecessary damage to the civil infrastructure and culturally sensitive sites.
- Providing civil component analysis to planning processes to protect—
 - The populace.
 - Critical assets.
 - Infrastructure.
- Advising on the presence of culturally, economically, and politically significant assets and resources within the objective area.

Note: JP 3-26 and ADP 3-05 provide more information on counterterrorism.

COUNTERING WEAPONS OF MASS DESTRUCTION

C-15. SOF support USG efforts to curtail the development, possession, proliferation, use, and effects of weapons of mass destruction, related expertise, materials, technologies, and means of delivery by state and non-state actors. USSOCOM supports CCDRs through technical expertise, materiel, and special teams to complement other combatant command teams that locate, tag, and track weapons of mass destruction.

C-16. The CA contribution to countering weapons of mass destruction is CAO. CAO support the USG strategic approach and lines of effort to prevent acquisition, contain or reduce threats, and provide information to understand weapons of mass destruction pathways. CAO also support the USG by identifying partner nation capabilities to respond to weapons of mass destruction events. These efforts—

- Promote weapons of mass destruction and chemical, biological, radiological, and nuclear threat awareness.
- Improve military interoperability.
- Enhance military and civilian preparedness and deterrence.
- In some cases facilitate security of dual-use and chemical, biological, radiological, and nuclear materials.

Note: JP 3-40, JP 3-05, and ADP 3-05 provide additional information on countering weapons of mass destruction.

CIVIL-MILITARY ENGAGEMENT

C-17. CME is USSOCOM's contribution, and part of the DOD's strategy, to building partner nation capacity in a preventive, population-centric, and indirect approach to enhance the capability, capacity, and legitimacy of partnered indigenous governments. CME is persistent engagement conducted by, with, and through unified

action partners to shape and influence the IPI within the OE in support of the campaign plan of CCDR and the campaign support plan of the TSOC, in conjunction with U.S. embassy strategies. The CME program—

- Increases the capability of USG-supported IPI.
- Reduces the influence of malign actors within targeted countries and regions.
- Leverages civil vulnerabilities and resiliencies within the OE.
- Engages with civil networks to provide access, information, and effects across the competition continuum.

Note: The CME program is described in Chapter 5.

This page intentionally left blank.

Appendix D

Civil Affairs Graphic Control Measures

This appendix shows a variety of symbols and graphic control measures related to CA and CA tactical mission tasks. The appendix does not attempt to produce all conceivable combinations for CA symbols or control measures, but it shows several examples of each type as a starting point.

OVERVIEW

D-1. A military symbol is a graphic representation of a unit, equipment, installation, activity, control measure, or tactical task relevant to military operations that is used for planning or to represent the common operational picture on a map or overlay. Military symbols are governed by the rules in MIL-STD-2525D. FM 1-02.2 also provides an extensive number of icons and modifiers for building a variety of framed symbols.

MODIFIERS FOR FRAMED SYMBOLS

D-2. A modifier provides an abstract pictorial or alphanumeric representation displayed inside the framed symbol in conjunction with a main icon. It provides information about the icon (unit, equipment, installation, or activity) being displayed. Sector 1 modifiers (or modifiers placed above the main icon) show a specific function that the unit is organized and equipped to perform. Sector 2 modifiers (or modifiers placed below the main icon) reflect the mobility, size, range, or altitude of unit equipment, or an additional capability of the unit.

AMPLIFIERS FOR FRAMED SYMBOLS

D-3. An amplifier provides additional information about the symbol being shown and is displayed outside the frame. To avoid cluttering the display, only essential amplifier fields should be used. The amplifier location in the figure E-1 have changed from previous editions of FM 1-02.2. The locations also vary from MIL-STD-2525D. Figure D-1 and table D-1, pages D-2 through D-3, standardize the field locations of additional information.

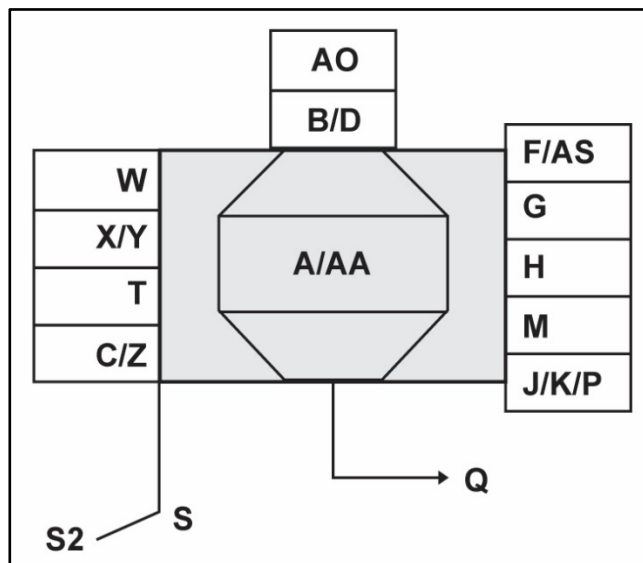


Figure D-1. Main and modifier icon and amplifier placement locations

Table D-1. Description of main icon and amplifier fields for unit frames

Field	Field Title	Description
A	Main and modifier icons	The innermost part of a symbol that represents the main function (main icon) and its capabilities (modifiers 1 and 2).
B	Echelon	A graphic amplifier in a unit symbol that identifies command level.
C	Quantity	A text amplifier that identifies a specific number and type of items.
D	Task force indicator	A graphic amplifier that identifies a unit or activities symbol as a task force.
F	Attached and detached (reinforced or reduced)	A text amplifier in a unit symbol that displays (+) for reinforced, (-) for reduced, (+) reinforced and reduced. Note: A maximum of 3 characters are allowed in this field.
G	Staff comments	A text amplifier for units, equipment, and installations; content is implementation specific. Note: A maximum of 20 characters are allowed in this field.
H	Additional information	A unique alphanumeric designation that identifies the unit being displayed. Note: A maximum of 20 characters are allowed in this field.
J	Evaluation rating	A text amplifier for units, equipment, and installations that consists of a single-letter reliability rating and single-digit credibility rating. Reliability Ratings: A—completely reliable. B—usually reliable. C—fairly reliable. D—not usually reliable. E—unreliable. F—reliability cannot be judged. Credibility Ratings: 1—confirmed by other sources. 2—probably true. 3—possibly true. 4—doubtfully true. 5—improbable. 6—truth cannot be judged. Note: A maximum of 2 characters are allowed in this field.
K	Combat effectiveness	A text amplifier for units and installations that indicates effectiveness. The entries are— Fully operational (FO). Substantially operational (SO). Marginally operational (MO). Not operational (NO). Unknown (UNK). Note: A maximum of 5 characters are allowed in this field.
M	Higher echelon formation	A text amplifier for units that indicates number or title of higher echelon command (corps are designated by Roman numerals). Note: A maximum of 5 characters are allowed in this field.
P	Identification, friend or foe Selective identification feature	A text amplifier displaying one or more identification, friend or foe, or selective identification feature, identification modes and codes. Display priority is mode 5, mode 4, mode 3, and mode 2. Note: A maximum of 15 characters allowed in this field.

Table D-1. Description of main icon and amplifier fields for unit frames (continued)

Field	Field Title	Description
Q	Direction of movement indicator	A graphic amplifier for units and equipment that identifies the direction of movement or intended movement of an object.
S S2	Offset location indicator	A graphic amplifier used to indicate the offset or precise location.
T	Unique identifier	<p>1. An amplifier field reserved for command and control systems that uniquely identifies a particular symbol with a track number. Prefix = TN ##### Example: TN: 13579</p> <p>2. May also be used for unit designation. Note: A maximum of 30 characters are allowed in this field.</p>
W	Date-time group	<p>An alphanumeric designator for displaying a date-time group (DDHHMMSSZMONYYYY), or O/O for on order. The date-time group is composed of a group of six numeric digits with a time zone suffix, and the standardized three-letter abbreviation for the month, followed by four digits representing the year. The first pair of digits represents the day; the second pair, the hour; the third pair, the minutes; and the fourth pair, the seconds. For automated systems, two digits may be added before the time zone suffix and after the minutes to designate seconds. Note: A maximum of 16 characters are allowed in this field.</p>
X	Altitude or depth	<p>A text amplifier that displays either altitude, flight level, depth for submerged objects, or height of equipment or structures on the ground. Measurement units will be displayed within the string. Example 1: 1500 MSL Example 2: FL150 Note: A maximum of 14 characters are allowed in this field.</p>
Y	Location	<p>A text amplifier that displays a symbol's location in degrees, minutes, and decimal minutes (or in military grid reference system, global area reference system, or other applicable display formats). Note: A maximum of 14 characters are allowed in this field.</p>
Z	Speed	<p>A text amplifier for units and equipment that displays velocity. Note: A maximum of 8 characters are allowed in this field.</p>
AA	Offset location indicator	<p>A text modifier for units. The indicator is contained inside the frame. A named command such as, Supreme Headquarters Allied Powers, Europe; United States Southern Command; United States Central Command; and joint, multinational, or coalition commands such as, combined joint task forces or joint task forces. Note: A maximum of 9 characters are allowed in this field.</p>
AO	Engagement bar	<p>A graphic amplifier, placed immediately atop the symbol, which may denote— Local or remote status. Engagement status. Weapon type.</p> <p>The engagement amplifier is arranged as A:BBB-CC A (1 character) denotes a local, versus remote, engagement. BBB (up to 3 characters) denotes engagement state. CC (up to 2 characters) denotes weapon deployment or asset control.</p>
AS	Country	<p>A three-letter code that indicates the country of origin of the organization. In stability activities, this field can be used for factions or groups. Note: A maximum of 3 characters are allowed in this field.</p>

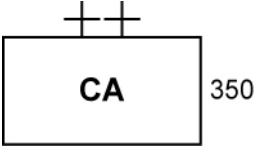
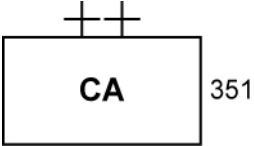
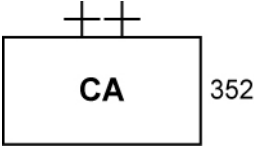
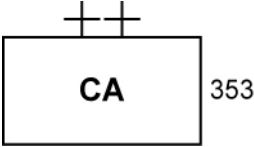
CIVIL AFFAIRS UNIT OR ELEMENT SYMBOLS

D-4. The symbols in the tables that follow portray the different types of CA units and elements. These tables also depict how to use modifiers and amplifiers, which affords the opportunity to show additional information about the main icon.

CIVIL AFFAIRS COMMANDS

D-5. Table D-2 shows the framed symbol for a CACOM. The symbol is comprised of the main icon, CA, inside the frame, reflecting the main function of the symbol. In addition to the main icon, there is the echelon amplifier for command above the frame and the unique alphanumeric unit designation amplifier for the unit on the right side of the frame.

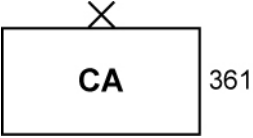
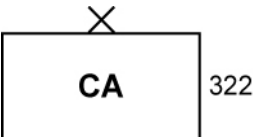
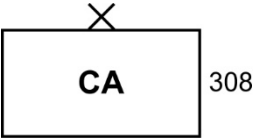
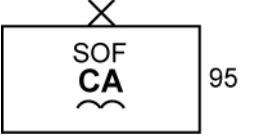
Table D-2. Civil Affairs command framed symbols

Symbol	Title	Description
	350th Civil Affairs Command	Basic framed symbol for a Civil Affairs command with the echelon amplifier for command and the unique alphanumeric unit designation amplifier outside the frame.
	351st Civil Affairs Command	
	352d Civil Affairs Command	
	353d Civil Affairs Command	

CIVIL AFFAIRS BRIGADES

D-6. Table D-3 shows the framed symbol for CA brigades. The basic CA brigade symbol is comprised of the main icon for CA inside the framed symbol. Each symbol also has the brigade echelon amplifier centered above and outside the frame and unique alphanumeric unit designation amplifiers outside the right edge of the frame.

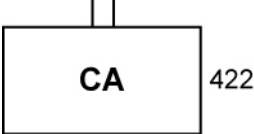
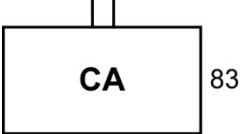


Table D-3. Civil Affairs brigade framed symbols

Symbol	Title	Description
	361st Civil Affairs Brigade	Basic framed symbol for a Civil Affairs brigade with the echelon amplifier for brigade and the unique alphanumeric unit designation amplifier outside the frame.
	322d Civil Affairs Brigade	
	308th Civil Affairs Brigade	
	95th Civil Affairs Brigade (Special Operations) (Airborne)	

CIVIL AFFAIRS BATTALIONS

D-7. Table D-4 shows the framed symbol for CA battalions. The basic CA battalion symbol is comprised of the main icon for CA inside the framed symbol. Each symbol also has the echelon for brigade centered above and outside the frame and the unique alphanumeric unit designation amplifiers outside the right edge of the frame.

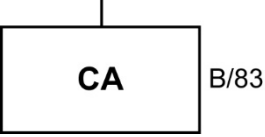
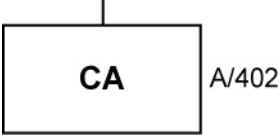
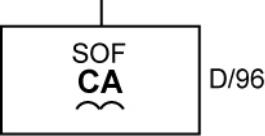
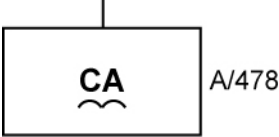
Table D-4. Civil Affairs battalion framed symbols

Symbol	Title	Description
	422d Civil Affairs Battalion	Basic framed symbol for a Civil Affairs battalion with the echelon amplifier for battalion and the unique alphanumeric unit designation amplifier outside the frame.
	83d Civil Affairs Battalion	
	92d Civil Affairs Battalion (Special Operations) (Airborne)	The same symbol for a Civil Affairs battalion, with the addition of the special operations forces modifier in the sector 1 location, and airborne modifier in the sector 2 location.
	426th Civil Affairs Battalion (Airborne)	The same symbol for a Civil Affairs battalion, with the addition of the airborne modifier in the sector 2 location.

CIVIL AFFAIRS COMPANY

D-8. Table D-5 shows the framed symbol for CA companies. The symbol is comprised of the main icon for CA inside the framed symbol. Each symbol has the echelon amplifier for company centered above and outside the frame and the unique alphanumeric unit designation amplifiers outside the right edge of the frame.

Table D-5. Civil Affairs company framed symbols

Symbol	Title	Description
	B Company, 83d Civil Affairs Battalion	Basic framed symbol for a Civil Affairs company with the echelon amplifier for company and the unique alphanumeric unit designation amplifier outside the frame.
	A Company, 402d Civil Affairs Battalion	
	D Company, 96th Civil Affairs Battalion (Special Operations) (Airborne)	The same symbol for a Civil Affairs company, with the addition of the special operations forces modifier in the sector 1 location, and the airborne modifier in the sector 2 location.
	A Company, 478th Civil Affairs Battalion (Airborne)	The same symbol for a Civil Affairs company, with the addition of the airborne modifier in the sector 2 location.

CIVIL AFFAIRS COMMAND, BRIGADE, BATTALION, AND COMPANY HEADQUARTERS

D-9. Every echelon, from CACOM through CA company, has a headquarters or headquarters element. In Table D-6, a horizontal line across the sector 1 modifier field, inside the framed symbol, depicts the headquarters or headquarters element. The rest of the symbol is the same as in the preceding tables.

Table D-6. Civil Affairs headquarters elements framed symbols

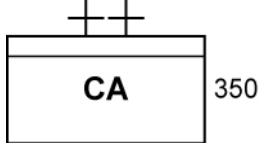
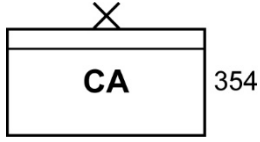
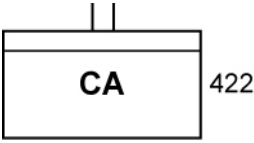
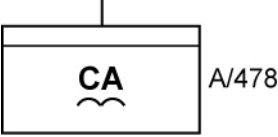
Symbol	Title	Description
	Headquarters, 350th Civil Affairs Command	Basic framed symbol for a Civil Affairs command, with the addition of the headquarters element modifier in the sector 1 location.
	Headquarters, 354th Civil Affairs Battalion	Basic framed symbol for a Civil Affairs brigade, with the addition of the headquarters element modifier in the sector 1 location.

Table D-6. Civil Affairs headquarters elements framed symbols (continued)

Symbol	Title	Description
	Headquarters, 422d Civil Affairs Battalion	Basic framed symbol for a Civil Affairs battalion, with the addition of the headquarters element modifier in the sector 1 location.
	Headquarters, A Company 478th Civil Affairs Battalion (Airborne)	Basic framed symbol for a Civil Affairs company, with the addition of the headquarters element modifier in the sector 1 location and the airborne modifier in the sector 2 location.

CIVIL AFFAIRS TEAMS

D-10. Table D-7 shows the framed symbol for CATs. The basic CAT symbol is comprised of the main icon for CA inside the framed symbol. Each CAT symbol has the echelon amplifier for team centered above and outside the frame and the unique alphanumeric unit designation amplifiers outside the right edge of the frame. Active Component special operations CATs use 3-digit identifiers, and active component conventional CATs use 4 digit identifiers. Reserve component conventional CATs do not have a standardized team numbering convention.

Table D-7. Civil Affairs team framed symbols

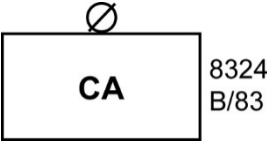
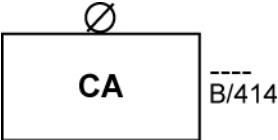
Symbol	Title	Description
	Civil Affairs Team 8324, B Company, 83d Civil Affairs Battalion	Basic framed symbol for a Civil Affairs team, with the echelon amplifier for team and the unique alphanumeric unit designation amplifier. The first two numbers in the Civil Affairs team naming convention are for the battalion; in this example this is 83 for the 83d. The next number is for the company (example: A Co-1, B Co-2, C Co-3, and so on). The final number is the team within the company.
	Civil Affairs Team ----, B Company, 414th Civil Affairs Battalion	Basic framed symbol for a Civil Affairs team, with the echelon amplifier for team and the unique alphanumeric unit designation amplifier. A team naming convention for United States Army Civil Affairs and Psychological Operations Command does not exist.

Table D-7. Civil Affairs team framed symbols (continued)

Symbol	Title	Description
	<p>Civil Affairs Team 642, D Company, 96th Civil Affairs Battalion (Special Operations) (Airborne)</p>	<p>Basic framed symbol for a Civil Affairs team, with the echelon amplifier for team and the unique alphanumeric unit designation amplifier. The first two numbers in the Civil Affairs team naming convention are for the battalion; in this example this is 96 for the 96th. The next number is for the company (example: A Co-1, B Co-2, C Co-3, and so on). The final number is the team within the company. In addition, the special operations forces modifier is included in the sector 1 location, and the airborne modifier is included in the sector 2 location.</p>
	<p>Civil Affairs Team ----, C Company, 416th Civil Affairs Battalion (Airborne)</p>	<p>Basic framed symbol for a Civil Affairs team, with the echelon amplifier for team and the unique alphanumeric unit designation amplifier. A team naming convention for the United States Army Civil Affairs and Psychological Operations Command does not exist. In addition, the airborne modifier is included in sector 2.</p>

CIVIL AFFAIRS ELEMENTS

D-11. Table D-8 demonstrates the building of symbols for all levels of CAPTs, CMOCs, and CLTs. The symbol is comprised of the main icon for CA inside the framed symbol. The echelon of each element is shown as an amplifier centered above on the outside of the framed symbol. The level of where these elements are from can only be depicted with the unique alphanumeric unit designation amplifiers on the right edge outside the frame.

Table D-8. Civil Affairs elements

Symbol	Title	Description
	<p>351st Civil Affairs Command, Civil Affairs Planning Team</p>	<p>Framed symbol for a Civil Affairs planning team is comprised of the main icon for CA, with the echelon amplifier for team, and the unique alphanumeric unit designation amplifier. (This is the only way to show the level of the Civil Affairs planning team.)</p>
	<p>308th Civil Affairs Brigade, Civil Affairs Planning Team</p>	<p>The framed symbol for a Civil Affairs planning team is comprised of the main icon for Civil Affairs echelon amplifier for team and the unique alphanumeric unit designation amplifier. (This is the only way to show the level of the Civil Affairs planning team.)</p>

Table D-8. Civil Affairs elements (continued)







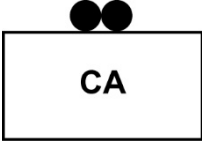

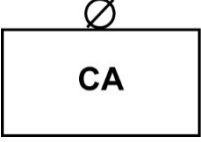
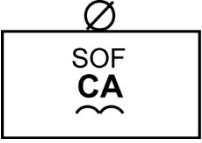
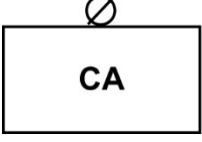

Symbol	Title	Description
	<p>92d Civil Affairs Battalion (Special Operations) (Airborne) Civil Affairs Planning Team</p>	<p>Framed symbol for a Civil Affairs planning team is comprised of the main icon for Civil Affairs, with the echelon amplifier for team, and the unique alphanumeric unit designation amplifier. (This is the only way to show the level of the Civil Affairs planning team.) In addition, the modifier for special operations forces is included in the sector 1 location and the airborne modifier is in the sector 2 location.</p>
	<p>97th Civil Affairs Battalion (Special Operations) (Airborne) Civil Affairs Planning Team</p>	<p>Framed symbol for a Civil Affairs planning team is comprised of the main icon for Civil Affairs, with the echelon amplifier for team, and the unique alphanumeric unit designation amplifier. (This is the only way to show the level of the Civil Affairs planning team.) In addition, the modifier for forward is included in the sector 1 location and the airborne modifier is in the sector 2 location.</p>
	<p>United States Army, Europe Theater Civil Affairs Planning Team</p>	<p>Framed symbol for a theater Civil Affairs planning team is comprised of the main icon for Civil Affairs, with the echelon amplifier for team and the unique alphanumeric unit designation amplifier for the unit.</p>
	<p>353d Civil Affairs Command Civil-Military Operations Center</p>	<p>Framed symbol for a civil-military operations center is comprised of the main icon for Civil Affairs, with the echelon amplifier for section, and the unique alphanumeric unit designation amplifier. (This is the only way to show the level of the civil-military operations center.)</p>
	<p>308th Civil Affairs Brigade Civil-Military Operations Center</p>	<p>Framed symbol for a civil-military operations center is comprised of the main icon for Civil Affairs, with the echelon amplifier for section, and the unique alphanumeric unit designation amplifier. (This is the only way to show the level of the civil-military operations center.)</p>
	<p>415th Civil Affairs Battalion Civil-Military Operations Center</p>	<p>Framed symbol for a civil-military operations center is comprised of the main icon for Civil Affairs, with the echelon amplifier for section, and the unique alphanumeric unit designation amplifier. (This is the only way to show the level of the civil-military operations center.)</p>

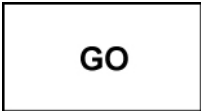

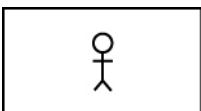
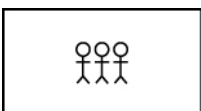
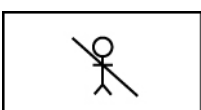
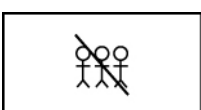
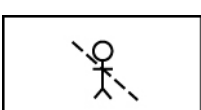
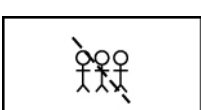
Table D-8. Civil Affairs elements (continued)

Symbol	Title	Description
 <p>CMOC B/83 BN</p>	<p>B Company 83d Civil Affairs Battalion Civil-Military Operations Center</p>	<p>Framed symbol for a civil-military operations center is comprised of the main icon for Civil Affairs, with echelon amplifier for section, and the unique alphanumeric unit designation amplifier. (This is the only way to show the level of the civil-military operations center.)</p>
 <p>CMSE C/92 BN</p>	<p>Civil-Military Support Element, C Company 92d Civil Affairs Battalion (Special Operations) (Airborne)</p>	<p>Framed symbol for a civil-military support element is comprised of the main icon for Civil Affairs, with the echelon amplifier for section and the unique alphanumeric unit designation amplifier. In addition, the modifier for special operations forces is in the sector 1 location and the airborne modifier is in the sector 2 location.</p>
 <p>CLT 350 CACOM</p>	<p>350th Civil Affairs Command Civil Liaison Team</p>	<p>Framed symbol for a civil liaison team is comprised of the main icon for Civil Affairs, with the echelon amplifier for team, and the unique alphanumeric unit designation amplifier. (This is the only way to show the level of the civil liaison team.)</p>
 <p>CLT 95 CA BDE</p>	<p>95th Civil Affairs Brigade (Special Operations) (Airborne) Civil Liaison Team</p>	<p>Framed symbol for a civil liaison team is comprised of the main icon for Civil Affairs, with the echelon amplifier for team, and the unique alphanumeric unit designation amplifier. (This is the only way to show the level of the civil liaison team.) In addition, the modifier for special operations forces is in the sector 1 location and the airborne modifier is in the sector 2 location.</p>
 <p>CLT 492 CA BN</p>	<p>492d Civil Affairs Battalion Civil Liaison Team</p>	<p>Framed symbol for a civil liaison team is comprised of the main icon for Civil Affairs, with the echelon amplifier for team, and the unique alphanumeric unit designation amplifier. (This is the only way to show the level of the civil liaison team.)</p>
 <p>CMAG 95 CA BDE</p>	<p>95th Civil Affairs Brigade (Airborne) Civil-Military Advisory Group</p>	<p>Framed symbol for a civil-military advisory group is comprised of the main icon for Civil Affairs, with the echelon amplifier for section, and the unique alphanumeric designation amplifier for the 95th. In addition, the modifier for special operations forces is in the sector 1 location and the airborne modifier is in the sector 2 location</p>

MAIN ICONS FOR ORGANIZATIONS AND INDIVIDUALS

D-12. The military has a much larger role beyond fighting wars. The symbols in table D-9 are a recognition that military forces are often engaged in stability activities and support to civil authorities across the world. Table D-9 shows individual and organization symbols that represent civilians; however, these symbols do not have prescribed structures. The organization symbols can reflect civic, ethnic, religious, social, or other groups. The framed symbols below are in the friendly standard identity frame, which is rectangular in shape. For a more comprehensive list of symbols for units, individuals, and organizations, refer to FM 1-02.2, or MIL-STD 2525D.

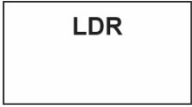
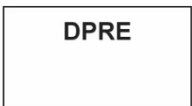
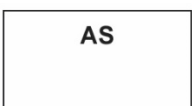
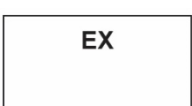
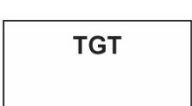

Table D-9. Organizations and individuals

Main Icon	Name	Description
	Governmental organization	Framed symbol for a governmental organization comprised of the main icon for a governmental organization.
	Nongovernmental organization	Framed symbol for a nongovernmental organization comprised of the main icon for a nongovernmental organization
	Unspecified individual	Framed symbol comprised of the symbol for unspecified individual.
	Unspecified organization	Framed symbol comprised of the symbol for unspecified organization.
	Criminal activities victim	Framed symbol comprised of the symbol for unspecified individual with the modifier for victim.
	Criminal activities victims	Framed symbol comprised of the symbol for unspecified organization with the modifier for victim.
	Attempted criminal activities victim	Framed symbol comprised of the symbol for unspecified individual with a modifier for attempted crime.
	Attempted criminal activities victims	Framed symbol comprises of the symbol for unspecified organization with a modifier for attempted crime.

MODIFIERS FOR CIVILIAN INDIVIDUAL AND ORGANIZATIONS

D-13. Table D-10 shows modifiers that reflect the function of civilian individuals or organizations. Some modifiers are framed in the friendly standard identity frame (rectangular shape), others are framed in the hostile standard identity frame (diamond shape).

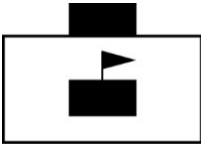
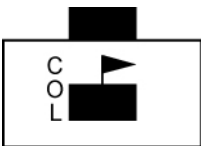
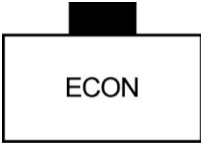
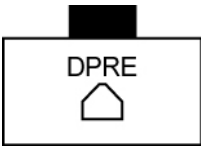
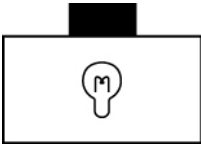
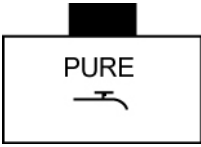
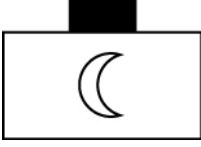
Table D-10. Modifiers for individuals and organizations

Modifier	Name	Description
	Leader	Modifiers in these sections are used to add more detail to the main icons, giving the user a way to provide additional information. (These are not complete symbols, but mere representations of the location of the modifiers in the symbols.)
	Displaced persons, refugees, and evacuees	
	Assassination victim(s)	
	Execution victim(s)	
	Targeted person, group, or organization	
	Terrorist person, group, or organization	

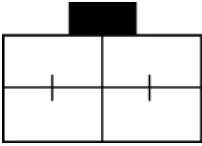

CIVILIAN INSTALLATIONS

D-14. Installations are sites that vary from permanent to temporary structures. Icons in the main sector represent the main function of the symbol and sector 1 modifiers reflect specific capabilities of the installation. The framed symbols below are in the friendly standard identity frame (rectangular shape). Table D-11, pages D-14 and D-15, shows common examples of civil installations.

Table D-11. Civilian installations

Symbol	Name	Description
	<p>School or educational institution</p>	<p>Framed symbol for a school or educational facility comprised of the main icon for school, along with the filled in rectangle in the echelon amplifier location representing an installation.</p>
	<p>College or university</p>	<p>Framed symbol for a school or educational facility comprised of the main icon for school, along with the filled in rectangle in the echelon amplifier location representing an installation. The symbol also has a sector 1 modifier for college or university.</p>
	<p>Economic installation</p>	<p>Framed symbol for an economic installation (bank, tax office, and so on) comprises of the main icon for economic, along with the filled in rectangle in the echelon amplifier location representing an installation.</p>
	<p>Displaced persons, refugees, and evacuees tented camp</p>	<p>Framed symbol for a displaced persons, refugees, and evacuees camp comprised of the main icon for tented camp, along with the filled in rectangle in the echelon amplifier location representing an installation. The symbol has a sector 1 modifier for displaced persons, refugees, and evacuees.</p>
	<p>Electric power plant</p>	<p>Framed symbol for an electric power plant comprised of the main icon for electricity, along with the filled in rectangle in the echelon amplifier location representing an installation.</p>
	<p>Water treatment (purification)</p>	<p>Framed symbol for a water treatment facility comprised of the main icon for water, along with the filled in rectangle in the echelon amplifier location representing an installation. The symbol also has a sector 1 modifier for purification.</p>
	<p>Food</p>	<p>Framed symbol for a food distribution center comprised of the main icon for food, along with the filled in rectangle in the echelon amplifier location representing an installation.</p>

D-11. Civilian installations (continued)

Symbol	Name	Description
	Medical treatment facility	Framed symbol for a medical treatment facility comprised of the main icon for medical, along with the filled in rectangle in the echelon amplifier location representing an installation. The symbol also has modifiers for medical treatment facility.
	Safe house	Framed symbol for a safe house comprises of the main icon for a safe house, along with the filled in rectangle in the echelon amplifier location representing an installation.

CIVILIAN ACTIVITIES

D-15. Activity symbols are applicable across the competition continuum, but they normally focus on stability activities and DSCA activities. These activities may affect military operations. Table D-12 shows common examples of civilian activities. Icons in the main sector reflect the main function of the symbol. Some of are framed in the friendly standard identity frame (rectangular shape), others are framed in the hostile standard identity frame (diamond shape). FM 1-02.2 provides a more extensive list of icons and modifiers for activities.

Table D-12. Civilian activities


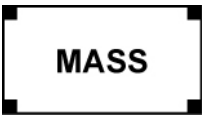
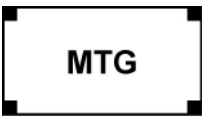





Symbol	Name	Description
	Election, voting, or polling place	Symbol used to designate a specific activity on both overlays or in civil information management products.
	Demonstration	
	Meeting	
	Black market	

Table D-12. Civilian activities (continued)

Symbol	Name	Description
	<p>Type of killing (murder)</p>	<p>Symbol used to designate a specific activity on both overlays or in civil information management products.</p>
	<p>Type of killing (assassination)</p>	
	<p>Type of killing (execution)</p>	
	<p>Riot</p>	

CIVIL AFFAIRS GRAPHICS CONTROL MEASURES

D-16. A graphic control measure is a graphic used on a map or overlay to regulate forces and warfighting functions. Control measure symbols generally fall into one of three categories: points, lines, and areas. These symbols can be combined with other military symbols, icons, and amplifiers to display operational information. The only modifiers that are used for graphic control measures are chemical, biological, radiological, and nuclear events and contaminated areas. Figures D-2 and D-3, and table D-13, page D-18, show the description of control measure symbol amplifier fields and the standardized placements.

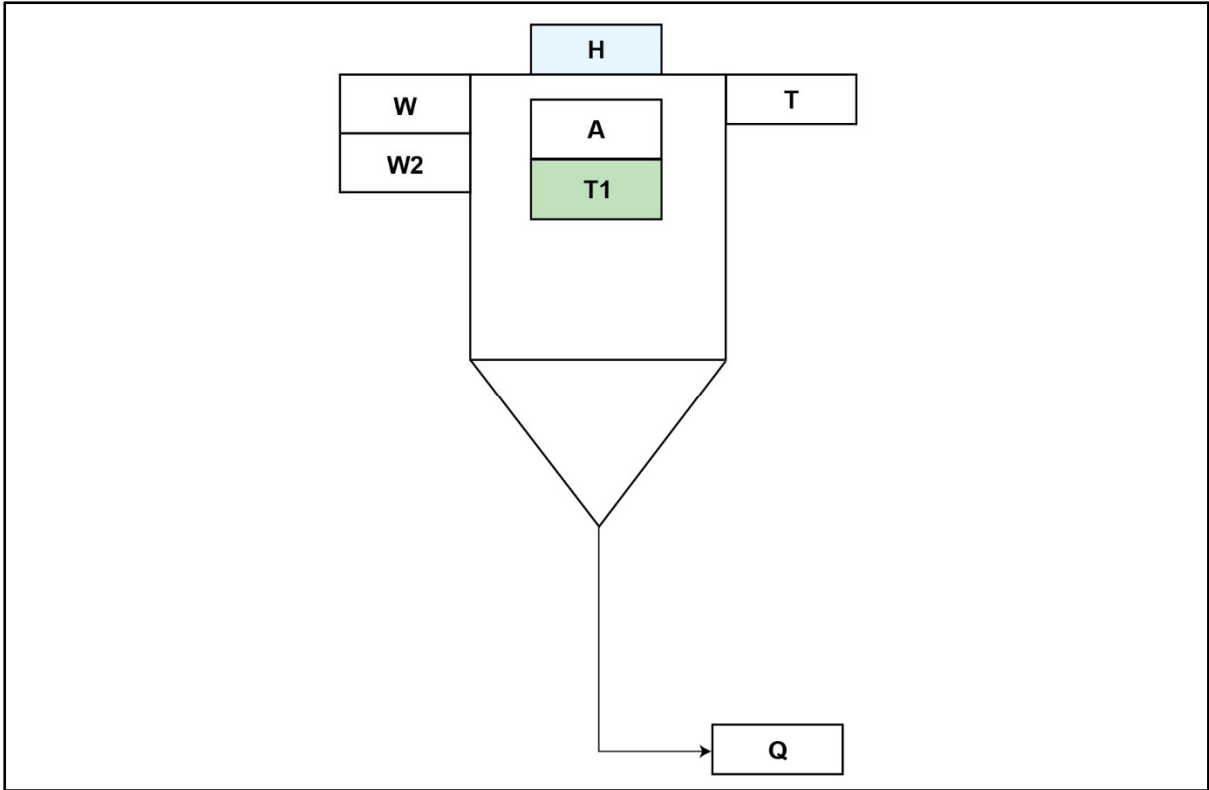


Figure D-2. Standard template point

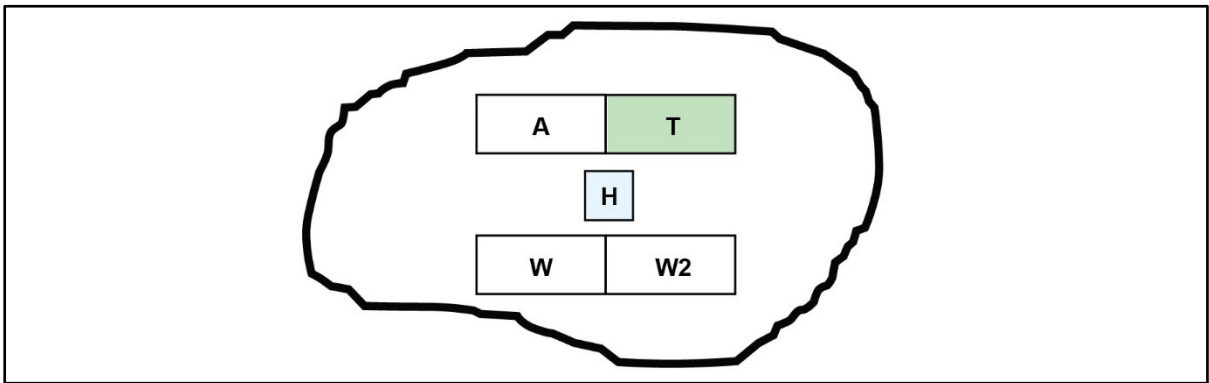


Figure D-3. Standard area template

Table D-13. Amplifier descriptions for control measure symbols

Field	Field Title	Description
A	Symbol icon	The part of the symbol that represents the unit symbol, or object function (modifier).
B	Echelon	This is a unit symbol that identifies command level.
C	Quantity	This identifies the number of items present.
H	Additional information	This content is implementation specific.
N	Hostile (enemy)	The letters ENY denote hostile control measure symbols.
Q	Direction of movement indicator	Identifies the direction of movement (or intended movement) of an object.
S	Offset location indicator	For points and chemical, biological, radiological, and nuclear events, used for placing an object away from its actual location.
T, T1	Unique designation	T is used to differentiate points by numbering, lettering, or a combination of both. T1 may be used to include the unit designation. Notes: 1. In some cases, this tactical symbol may require multiple instance of a T amplifier to fully create or represent an object. 2. T1 may be used if the field used is displayed more than once in a tactical symbol. 3. The unnumbered fields should be filled before the numbered fields.
V	Type	Indicates type of equipment or nuclear weapon type.
W, W2	Date-time group	W identifies the start date-time group, and it can be displayed alone or in conjunction with W2 to identify the projected date-time group end date. The W represents an alphanumeric designator for displaying a date-time group (DDHHMMSSZMONYYYY), or O/O, for on order. When W and W2 are used in conjunction, this identifies the time control measure is in effect. The date-time group is composed of a group of six numeric digits with a time zone suffix, and the standardized three-letter abbreviation for the month, followed by four digits representing the year. The first pair of digits represents the day; the second pair, the hour; and the third pair, the minutes. The last four digits, after the month, represent the year. For automated systems, two digits may be added before the time zone suffix and after the minutes to designate seconds.
X	Altitude or depth	Displays the minimum, maximum, or specific altitude (in feet or meters) in relation to a reference datum and the flight level or depth for submerged objects (in feet below sea level).
Y	Location	Displays the location of a symbol in degrees, minutes, and decimal minutes.
AM	Distance	An alphanumeric amplifier that displays a minimum, maximum, or specific distance (including range, radius, width, or length) in meters.
AN	Azimuth	A numeric amplifier that displays an angle measured from true north to any other line—in degrees.
AP	Target number	A six-character text modifier used in fire support operations to uniquely designation targets where characters 1 and 2 are alphabetic, and characters 3 through 6 are numeric. Example: AANNNN (where A is alphabetic, and N is numeric)

CIVIL AFFAIRS TACTICAL MISSION TASKS

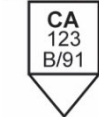
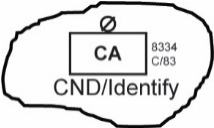
D-17. A tactical mission task is a specific activity performed by a unit while executing a tactical operation. Tactical task symbols are used in course-of-action sketches, synchronization matrices, and maneuver sketches. The following tables show examples of how CND, CR, and CE can be displayed using standard framed symbols in conjunction with control measure symbols.

Note: FM 1-02.2 provides further information on symbols for tactical mission tasks.

CIVIL NETWORK DEVELOPMENT

D-18. Table D-14 portrays examples of how CND can be displayed on a maneuver or course of action sketch. The control measure symbols use the standard point and area symbols combined with the CA main icon, unique unit designation, echelon, and free text amplifiers.


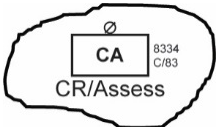
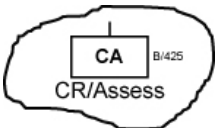

Table D-14. Civil network development symbols

Symbol	Example	Description
<p>CND/Identify</p>  <p>The symbol is a downward-pointing triangle with a vertical line through its center. Inside the triangle, the text 'CA' is at the top, '123' is in the middle, and 'B/91' is at the bottom.</p>	<p>Civil Affairs Team 123 conducts civil network development at a point of interest (grid coordinate or specific location) to meet with the mayor to identify sources of instability in the town.</p>	<p>The point civil network development symbol is comprised of the symbol for standard point. The main icon for Civil Affairs and the unique alphanumeric designation amplifier for the unit are included inside the symbol. In addition, the mission task acronym and the purpose verb for the mission task are in the number 5 amplifier position.</p>
 <p>The symbol is an irregular, hand-drawn area shape. Inside the area, there is a small circle with a diagonal slash. Below the circle, the text 'CA' is on the left, '8334' is on the right, and 'C/83' is below '8334'. Below the entire area symbol, the text 'CND/Identify' is written.</p>	<p>Civil Affairs Team 8334, C Company, 83d Civil Affairs Battalion conducts civil network development in a designated area to identify sources of instability.</p>	<p>The area civil network development control measure symbol is comprised of the symbol for an area. A framed symbol is included inside the area symbol with the main icon for Civil Affairs and the echelon and unique alphanumeric designation amplifiers for the unit. In addition, the mission task acronym and the purpose verb for the mission task are in the number 5 amplifier position.</p>

CIVIL RECONNAISSANCE

D-19. Table D-15 portrays examples of how CR can be displayed on a maneuver or course of action sketch. The control measure symbols use the standard point and area symbols combined with the CA main icon, unique unit designation, echelon, and free text amplifiers.

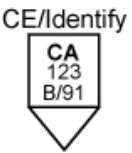
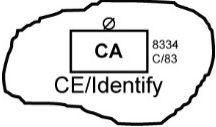
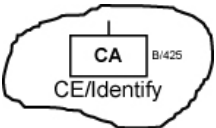
Table D-15. Civil reconnaissance symbols

Symbol	Example	Description
	<p>Civil Affairs Team 123 conducts civil reconnaissance at a specific point (grid coordinate or specific location) to assess for a specified reason.</p>	<p>The point civil reconnaissance symbol is comprised of the symbol for standard point. The main icon for Civil Affairs and the unique alphanumeric designation amplifier for the unit are included inside the symbol. In addition, the mission task acronym and the purpose verb for the mission task are in the number 5 amplifier position.</p>
	<p>Civil Affairs Team 8334, C Company, 83d Civil Affairs Battalion is ordered to conduct civil reconnaissance in a specified area to assess for a specified reason.</p>	<p>The area civil reconnaissance control measure symbol is comprised of the symbol for an area. A framed symbol is included inside the area symbol with the main icon for Civil Affairs and the echelon and unique alphanumeric designation amplifiers for the unit. In addition, the mission task acronym and the purpose verb for the mission task are in the number 5 amplifier position.</p>
	<p>B Company, 425th Civil Affairs Battalion is ordered to conduct civil reconnaissance in a specified area to assess for a specified reason.</p>	<p>The area civil reconnaissance control measure symbol is comprised of the symbol for an area. A framed symbol is included inside the area symbol with the main icon for Civil Affairs, and the echelon and unique alphanumeric designation amplifiers for the unit. In addition, the mission task acronym and the purpose verb for the mission task are in the number 5 amplifier position.</p>
	<p>A civil-military support element from B Company, 92d Civil Affairs Battalion is ordered to conduct civil reconnaissance between designated locations to validate certain information.</p>	<p>The linear civil reconnaissance symbol is comprised of the symbol for a designated linear area for civil reconnaissance. The linear area would be between the points of the two arrows. A framed symbol is included with the main icon for Civil Affairs, the special operations forces modifier in sector 1 location, the airborne modifier in sector 2 location, and the echelon and unique alphanumeric designation amplifiers for the unit. In addition, the purpose verb for the mission task is in the number 5 amplifier position.</p>

CIVIL ENGAGEMENT

D-20. Table D-16 portrays examples of how CE can be displayed on a maneuver or course of action sketch. The control measure symbols use the standard point, area, and point of interest symbols combined with the CA main icon, unique unit designation, echelon, and free text amplifiers.

Table D-16. Civil engagement symbols

Symbol	Example	Description
	<p>Civil Affairs Team 123 conducts civil engagement at a point of interest (grid coordinate or specific location) to meet with the mayor to identify sources of instability in the town.</p>	<p>The point civil engagement symbol is comprised of the symbol for standard point. The main icon for Civil Affairs and the unique alphanumeric designation amplifier for the unit are included inside the symbol. In addition, the mission task acronym and the purpose verb for the mission task is in the number 5 amplifier position.</p>
	<p>Civil Affairs Team 8334, C Company, 83d Civil Affairs Battalion conducts civil engagement in a designated area to identify sources of instability.</p>	<p>The area civil engagement control measure symbol is comprised of the symbol for an area. A framed symbol is included inside the area symbol with the main icon for Civil Affairs and the echelon and unique alphanumeric designation amplifiers for the unit. In addition, the mission task acronym and the purpose verb for the mission task are in the number 5 amplifier position.</p>
	<p>B Company, 425th Civil Affairs Battalion conducts civil engagement in a designated area to identify sources of instability</p>	<p>The area civil engagement control measure symbol is comprised of the symbol for an area. A framed symbol is included inside the area symbol with the main icon for Civil Affairs and the echelon and unique alphanumeric designation amplifiers for the unit. In addition, the mission task acronym and the purpose verb for the mission task are in the number 5 amplifier position.</p>

This page intentionally left blank.

Glossary

SECTION I – ACRONYMS AND ABBREVIATIONS

ADP	Army doctrine publication
AO	area of operations
ARCENT	United States Army Central Command
ARNG	Army National Guard
ARSOF	Army special operations forces
ASCOPE	areas, structures, capabilities, organizations, people, events
ATP	Army techniques publication
BCT	brigade combat team
CA	Civil Affairs
CACOM	Civil Affairs command
CAO	Civil Affairs operations
CAPT	Civil Affairs planning team
CAT	Civil Affairs team
CCDR	combatant commander
CCIR	commander's critical information requirement
CE	civil engagement
CIE	civil information evaluation
CJCS GDE	Chairman of the Joint Chiefs of Staff guide
CKI	civil knowledge integration
CME	civil-military engagement
CMI	civil-military integration
CMO	civil-military operations
CMOC	civil-military operations center
CMSE	civil-military support element
CNA	civil network analysis
CND	civil network development
CNDE	civil network development and engagement
CONOPS	concept of operations
CPB	civil preparation of the battlefield
CR	civil reconnaissance
DA	Department of the Army
DC	dislocated civilian
DOD	Department of Defense
DODD	Department of Defense directive
DODI	Department of Defense instruction
DOS	Department of State
DSCA	defense support of civil authorities
FHA	foreign humanitarian assistance
FID	foreign internal defence
G-2	assistant chief of staff, intelligence
G-3	assistant chief of staff, operations
G-4	assistant chief of staff, logistics
G-5	assistant chief of staff, plans
G-9	assistant chief of staff, civil affairs operations

FM	field manual
FORSCOM	United States Army Forces Command
HN	host nation
IO	information operations
IPB	information preparation of the battlefield
IPI	indigenous populations and institutions
J-2	intelligence directorate of a joint staff
J-3	operations directorate of a joint staff
J-4	logistics directorate of a joint staff
J-5	plans directorate of a joint staff
J-9	civil-military operations/interagency cooperation directorate of a joint staff
JCMOTF	joint civil-military operations task force
JFC	joint force commander
JP	joint publication
JSOTF	joint special operations task force
JTF	joint task force
MDMP	military decisionmaking process
METT-TC	mission, enemy, terrain and weather, troops and support available-time available and civil considerations
NGO	nongovernmental organization
OE	operational environment
PMESII-PT	political, military, economic, social, information, infrastructure, physical environment, time
PRC	populace and resources control
PSYOP	Psychological Operations
RM	risk management
S-2	battalion or brigade intelligence staff officer
S-3	battalion or brigade operations staff officer
S-4	battalion or brigade logistics staff officer
S-5	battalion or brigade plans staff officer
S-9	battalion or brigade civil affairs operations staff officer
SA	security assistance
SCA	support to civil administration
SOF	special operations forces
TG	transitional governance
TSOC	theater special operations command
USACAPOC	United States Army Civil Affairs and Psychological Operations Command
USAID	United States Agency for International Development
USAJFKSWCS	United States Army John F. Kennedy Special Warfare Center and School
USAR	United States Army Reserve
USARSOC	United States Army Reserve Special Operations Command
USASOC	United States Army Special Operations Command
USC	United States Code
USCENTCOM	United States Central Command
USG	United States government
USSOCOM	United States Special Operations Command
UW	unconventional warfare

SECTION II – TERMS

Civil Affairs operations

Actions planned, coordinated, executed, and assessed to enhance awareness of, and manage the interaction with, the civil component of the operational environment; identify and reduce underlying causes of instability within civil society; and/or involve the application of functional specialty skills normally the responsibility of civil government. Also called **CAO**. (JP 3-57)

***civil engagement**

a targeted, planned, and coordinated meeting with known or potential contacts in a civil network that is designed to develop or maintain relationships and to share or collect information. Also called **CE**. (FM 3-57, proposed for inclusion in FM 1-02.1)

***civil information evaluation**

The evaluation of civil information for operational relevance and feasible courses of action. Also called **CIE**. (FM 3-57, proposed for inclusion in FM 1-02.1)

***civil knowledge integration**

The actions taken to analyze, evaluate, and organize collected civil information for operational relevance and informing the warfighting function. Also called **CKI**. (FM 3-57, proposed for inclusion in FM 1-02.1)

***civil military integration**

The actions taken to establish, maintain, influence, or leverage relations between military forces and indigenous populations and institutions to synchronize, coordinate, and enable interorganizational cooperation and to achieve unified action. Also called **CMI**. (FM 3-57, proposed for inclusion in FM 1-02.1)

***civil-military support element**

A task-organized Civil Affairs force established to plan, facilitate, and execute Civil Affairs operations in support of civil-military engagement in a specified country, region, or theater. Also called **CMSE**. (FM 3-57)

***civil network**

A collection of formal and informal groups, associations, military engagements, and organizations within an operational environment that interact with each other with varying degrees of frequency, trust, and collaboration. (FM 3-57, proposed for inclusion in FM 1-02.1)

***civil network analysis**

A process that identifies and analyzes the relative importance and influence of nodes within a civil network through network visualizations and qualitative and quantitative analytical methods. Also called **CNA**. (FM 3-57, proposed for inclusion in FM 1-02.1)

***civil network development**

The planned and targeted action in which Civil Affairs forces develop networks within the civil component of the operational environment to influence populations and manage local resources in order to extend the operational reach, consolidate gains, and achieve military objectives. Also called **CND**. (FM 3-57, proposed for inclusion in FM 1-02.1)

***civil network development and engagement**

The activity by which the civil network capabilities and resources are engaged, evaluated, developed, and integrated into operations. Also called **CNDE**. (FM 3-57, proposed for inclusion in FM 1-02.1)

***civil preparation of the battlefield**

The systematic process of analyzing civil considerations in an area of interest to determine their effects on friendly, neutral, and enemy operations. Also called **CPB**. (FM 3-57, proposed for inclusion in FM 1-02.1)

***civil preparation of the environment**

The continuous development of civil knowledge within an area of operations to help commanders identify capabilities within civil society that can be integrated with operations for stability and security activities. (FM 3-57, proposed for inclusion in FM 1-02.1)

command and control

The exercise of authority and direction by a properly designated commander over assigned and attached forces in the accomplishment of mission. Also called **C2**. (JP 1)

counterterrorism

Activities and operations taken to neutralize terrorists and their organizations and networks in order to render them incapable of using violence to instill fear and coerce governments or societies to achieve their goals. Also called **CT**. (JP 3-26)

cyberspace

A global domain within the information environment consisting of interdependent networks of information technology infrastructures and resident data, including the Internet, telecommunications networks, computer systems, and embedded processors and controllers. (JP 3-12).

defensive operation

An operation to defeat an enemy attack, gain time, economize forces, and develop conditions favorable for offensive or stability operations. (ADP 3-0)

fires warfighting function

The related tasks and systems that create and converge effects in all domains against the adversary or enemy to enable operations across the range of military operations. (ADP 3-0)

foreign humanitarian assistance

Department of Defense activities conducted outside the United States and its territories to directly relieve or reduce human suffering, disease, hunger, or privation. Also called **FHA**. (JP 3-29)

foreign internal defense

The participation by civilian and military agencies of a government in any of the action programs taken by another government or other designated organization to free and protect its society from subversion, lawlessness, insurgency, terrorism, and other threats to its security. Also known as **FID**. (JP 3-22)

governance

The state's ability to serve the citizens through the rules, processes, and behavior by which interests are articulated, resources are managed, and power is exercised in a society (JP 3-24).

homeland defense

The protection of United States sovereignty, territory, domestic population, and critical infrastructure against external threats and aggression or other threats as directed by the President. (JP 3-27)

host-nation support

Civil and/or military assistance rendered by a nation to foreign forces within its territory during peacetime, crises or emergencies, or war based on agreements mutually concluded between nations. Also called **HNS**. (JP 4-0)

information collection

An activity that synchronizes and integrates the planning and employment of sensors and assets as well as the processing, exploitation, and dissemination of systems in direct support of current and future operations. (FM 3-55)

information requirements

In intelligence usage, those items of information regarding the adversary and other relevant aspects of the operational environment that need to be collected and processed in order to meet the intelligence requirements of a commander. Also called **IR**. (JP 2-0)

intelligence preparation of the battlefield

The systematic process of analyzing the mission variables of enemy, terrain, weather, and civil considerations in an area of interest to determine their effect on operations. Also called **IPB**. (ATP 2-01.3).

intelligence warfighting function

The related tasks and systems that facilitate understanding the enemy, terrain, weather, civil considerations, and other significant aspects of the operational environment. (ADP 3-0)

interorganizational cooperation

The interaction that occurs among elements of the Department of Defense; participating United States Government departments and agencies; state, territorial, local, and tribal agencies; foreign military forces and government agencies; international organizations; nongovernmental organizations; and the private sector. (JP 3-08).

joint force

A force composed of elements, assigned or attached, of two or more Military Departments operating under a single joint force commander. (JP 3-0).

joint interagency coordination group

A staff group that establishes regular, timely, and collaborative working relationships between civilian and military operational planners. Also called **JIACG**. (JP 3-08).

joint operations

Military actions conducted by joint forces and those Service forces employed in specified command relationships with each other, which of themselves, do not establish joint forces. (JP 3-0).

movement and maneuver warfighting function

The related tasks and systems that move and employ forces to achieve a position of relative advantage over the enemy and other threats. (ADP 3-0)

offensive operation

An operation to defeat and destroy enemy forces and gain control of terrain, resources, and population centers. (ADP 3-0)

protection warfighting function

The related tasks and systems that preserve the force so the commander can apply maximum combat power to accomplish the mission. (ADP 3-0)

security cooperation

All Department of Defense interactions with foreign security establishments to build security relationships that promote specific United States security interests, develop allied and partner nation military and security capabilities for self-defense and multinational operations, and provide United States forces with peacetime and contingency access to allied and partner nations. Also called **SC**. (JP 3-20)

stability operation

An operation conducted outside the United States in coordination with other instruments of national power to establish or maintain a secure environment and provide essential governmental services, emergency infrastructure reconstruction, and humanitarian relief. (ADP 3-0)

support to civil administration

Assistance given by United States armed forces to stabilize or enhance the operations of the governing body of a foreign country by assisting an established or interim government. Also called **SCA**. (FM 3-57, proposed for inclusion in FM 1-02.1)

sustainment warfighting function

The related tasks and systems that provide support and services to ensure freedom of action, extended operational reach, and prolong endurance. (ADP 3-0)

***transitional governance**

The actions taken to assure appropriate control and continuity of government functions throughout the range of military operations. Also called **TG**. (FM 3-57, proposed for inclusion in FM 1-02.1)

transitional military authority

A temporary military government exercising the functions of civil administration in the absence of a legitimate civil authority (FM 3-07)

unconventional warfare

Activities conducted to enable a resistance movement or insurgency to coerce, disrupt, or overthrow a government or occupying power by operating through or with an underground, auxiliary, and guerrilla force in a denied area. (JP 3-05)

unified action

The synchronization, coordination, and/or integration of the activities of governmental and nongovernmental entities with military operations to achieve unity of effort (JP 1).

unity of effort

Coordination and cooperation toward common objectives, even if the participants are not necessarily part of the same command or organization, which is the product of successful unified action (JP 1).

References

All URLs accessed on 19 June 2021.

REQUIRED PUBLICATIONS

These documents must be available to intended users of this publication.

DOD Dictionary of Military and Associated Terms, as of January 2021.

FM 1-02.1. *Operational Terms*. 9 March 2021.

FM 1-02.2. *Military Symbols*. 10 November 2020.

RELATED PUBLICATIONS

These documents contain relevant supplemental information.

DEPARTMENT OF DEFENSE PUBLICATIONS

Most DOD issuances are available online: <https://www.esd.whs.mil/DD/>

DODD 2000.13. *Civil Affairs*. 11 March 2014.

DODD 2010.9. *Acquisition and Cross-Servicing Agreements*. 28 April 2003.

DODD 2060.02. *DoD Countering Weapons of Mass Destruction (WMD) Policy*. 27 January 2017.

DODD 3000.05. *Stabilization*. 13 December 2018.

DODD 3000.07. *Irregular Warfare (IW)*. 28 August 2014.

DODD 3025.18. *Defense Support of Civil Authorities (DSCA)*. 29 December 2010.

DODD 5100.01. *Functions of the Department of Defense and its Major Components*. 21 December 2010.

DODD 5100.46. *Foreign Disaster Relief (FDR)*. 6 July 2012.

DODD 5105.65. *Defense Security Cooperation Agency (DSCA)*. 26 October 2012.

DODD 5200.27. *Acquisition of Information Concerning Persons and Organizations Not Affiliated With The Department of Defense*. 7 January 1980.

DODI 3025.21. *Defense Support of Civilian Law Enforcement Agencies*. 27 February 2013.

DODI 5400.11. *DoD Privacy and Civil Liberties Programs*. 29 January 2019.

DODI 5530.3. *International Agreements*. 4 December 2019.

DSCA 5105.38-M. *Security Assistance Management Manual (SAMM)*. 30 April 2012. Available at <https://www.dsca.mil/resources/publications>.

JOINT PUBLICATIONS

Most joint publications are available online at: <https://www.jcs.mil/Doctrine>.

CJCS GDE 3130. *Adaptive Planning and Execution Overview and Policy Framework*. 5 March 2019.

JP 1. *Doctrine for the Armed Forces of the United States*. 25 March 2013.

JP 2-0. *Joint Intelligence*. 22 October 2013.

JP 3-0. *Joint Operations*. 17 January 2017.

JP 3-05. *Joint Doctrine for Special Operations*. 22 September 2020.

JP 3-07. *Stability*. 3 August 2016.

JP 3-08. *Interorganizational Cooperation*. 12 October 2016.

JP 3-12. *Cyberspace Operations*. 8 June 2018.

JP 3-20. *Security Cooperation*. 23 May 2017.

JP 3-22. *Foreign Internal Defense*. 17 August 2018.

JP 3-24. *Counterinsurgency*. 25 April 2018.

JP 3-26. *Joint Combating Terrorism*. 30 July 2020.

References

- JP 3-27. *Homeland Defense*. 10 April 2018.
- JP 3-28. *Defense Support of Civil Authorities*. 29 October 2018.
- JP 3-29. *Foreign Humanitarian Assistance*. 14 May 2019.
- JP 3-33. *Joint Task Force Headquarters*. 31 January 2018.
- JP 3-34. *Joint Engineer Operations*. 6 January 2016.
- JP 3-35. *Deployment and Redeployment Operations*. 10 January 2018.
- JP 3-40. *Joint Countering Weapons of Mass Destruction*. 27 November 2019.
- JP 3-57. *Civil-Military Operations*. 9 July 2018.
- JP 4-0. *Joint Logistics*. 4 February 2019.
- JP 5-0. *Joint Planning*. 1 December 2020.

DEPARTMENT OF THE ARMY PUBLICATIONS

- Most Army doctrinal publications are available online at: <https://armypubs.army.mil>.
- ADP 3-0. *Operations*. 31 July 2019.
 - ADP 3-05. *Army Special Operations*. 31 July 2019.
 - ADP 3-07. *Stability*. 31 July 2019.
 - ADP 3-28. *Defense Support of Civil Authorities*. 31 July 2019.
 - ADP 3-90. *Offense and Defense*. 31 July 2019.
 - ADP 5-0. *The Operations Process*. 31 July 2019.
 - ATP 2-01.3. *Intelligence Preparation of the Battlefield*. 1 March 2019.
 - ATP 3-05.1. *Unconventional Warfare at the Combined Joint Special Operations Task Force Level*. 9 April 2021.
 - ATP 3-05.2. *Foreign Internal Defense*. 19 August 2015.
 - ATP 3-18.1. *Special Forces Unconventional Warfare*. 21 March 2019.
 - ATP 3-18.3. *(U) Special Forces Direct Action Operations (C)*. 23 December 2015.
 - ATP 3-18.4. *Special Forces Special Reconnaissance*. 18 August 2015.
 - ATP 3-39.30. *Security and Mobility Support*. 21 May 2020.
 - ATP 3-57.10. *Civil Affairs Support to Populace and Resources Control*. 6 August 2013.
 - ATP 3-57.30. *Civil Affairs Support to Nation Assistance*. 1 May 2014.
 - FM 3-0. *Operations*. 6 October 2017.
 - FM 3-05. *Army Special Operations*. 9 January 2014.
 - FM 3-07. *Stability*. 2 June 2014.
 - FM 3-13. *Information Operations*. 6 December 2016.
 - FM 3-18. *Special Forces Operations*. 28 May 2014.
 - FM 3-22. *Army Support to Security Cooperation*. 22 January 2013.
 - FM 3-24. *Insurgencies and Countering Insurgencies*. 13 May 2014.
 - FM 3-39. *Military Police Operations*. 9 April 2019.
 - FM 3-55. *Information Collection*. 3 May 2013.
 - FM 6-0. *Commander and Staff Organization and Operations*. 5 May 2014.
 - FM 6-27/MCTP 11-10C. *The Commander's Handbook on the Law of Land Warfare*. 7 August 2019.

OBSOLETE PUBLICATIONS

This section contains references to obsolete historical doctrine. The Archival and Special Collections in the Combined Arms Research Library on Fort Leavenworth, in Kansas, contains copies. These publications are obsolete doctrine publications referenced for citations only.

FM 3-05.401/MCRP 3-33.1A. *Civil Affairs Tactics, Techniques, and Procedures*. 5 July 2007.

FM 27-5/OPNAV 50E-3. *United States Army and Navy Manual of Military Government and Civil Affairs*. 22 December 1943.

FM 27-10. *The Law of Land Warfare*. 18 July 1956.

FM 41-10. *Civil Affairs Operations*. 14 February 2000.

UNITED STATES LAW

Unless otherwise noted, most acts and public laws are available online at: <https://uscode.house.gov>.

10 USC. *Armed Forces*.

10 USC 401. *Humanitarian and civic assistance provided in conjunction with military operations*.

10 USC 2321. *Validation of proprietary data restrictions*.

10 USC 2667. *Leases: non-excess properties of military departments and Defense Agencies*.

10 USC 2675. *Leases: foreign countries*.

22 USC. *Foreign Relations and Intercourse*.

22 USC 2151. *Congressional findings and declaration of policy*.

22 USC 2292. *General provisions. (International Disaster Assistance)*

22 USC 2292b. *Disaster assistance coordination through a Special Coordinator for International Disaster Assistance; Presidential appointment and duties*.

22 USC 2796. *Leasing authority. (Arms Export Control)*

32 USC. *National Guard*.

Arms Export Control Act of 1976. (22 USC 2751 et seq.)

Foreign Assistance Act of 1961, as amended. (22 USC 2151 et seq.)

OTHER PUBLICATIONS

5 FAH-1 H-600. *Correspondence Handbook, Diplomatic Notes*. 7 February 2019.

<https://fam.state.gov/Default.aspx>.

1899 *Convention for the Pacific Settlement of International Disputes*. <https://www.loc.gov>.

1954 *Hague Convention for the Protection of Cultural Property in the Event of Armed Conflict*.

www.unesco.org.

American Military Government of Occupied Germany, 1918–1920: Report of the Officer in Charge of Civil Affairs, Third Army and American Forces in Germany,

https://history.army.mil/html/bookshelves/resmat/interwar_years/american_military_government_of_occupied_germany_1918-1920.pdf.

Center for Complex Operations. *The Kuwait Task Force: Postconflict Planning and Interagency Coordination*. Complex Operations Case Studies Series. Naval Postgraduate School. 2010.

https://cco.ndu.edu/Portals/96/Documents/case-studies/4-kuwait_task_force-teacher.pdf.

CMH Pub 70-100-1. *Weapon of Choice: ARSOF in Afghanistan*. 2003.

<https://history.army.mil/catalog/index.html>

Convention for the Protection of Cultural Property in the Event of Armed Conflict with Regulations for the Execution of the Convention 1954. 14 May 1954. <http://www.unesco.org/>.

Law and Customs of War on Land (Hague, II), <https://www.loc.gov/>.

Lincoln, Abraham. *General Orders No. 100*. 24 April 1863.

https://avalon.law.yale.edu/19th_century/lieber.asp.

MIL-STD-2525D. *Joint Military Symbolology*. 10 June 2014. <https://assist.dla.mil>.

References

NSPD-44. *Management of Interagency Efforts Concerning Reconstruction and Stabilization*.
7 December 2005. <https://www.dhs.gov/presidential-directives>.

Part 181, Title 22 Code of Federal Regulations. *Coordination, Reporting and Publication of International Agreements*. <https://ecfr.federalregister.gov/>.

Rules of Land Warfare 1914. <https://www.loc.gov/>.

Rules of Land Warfare 1934. <https://www.loc.gov/>.

The Geneva Conventions of 1949 and Hague Convention No. IV of 1907. <https://www.loc.gov/>.

Yates, Lawrence A. *The US Military's Experience in Stability Operations, 1789-2005: Global War on Terrorism Occasional Paper 15*.

PRESCRIBED FORMS

This section contains no entries.

REFERENCED FORMS

Unless otherwise indicated, DA forms are available online at: <https://armypubs.army.mil>.

DA Form 2028. *Recommended Changes to Publications and Blank Forms*.

Index

Entries are listed by paragraph number.

- A**
- Annex G, 5-9, 5-10, 5-13, 5-42
 - Annex K, 4-23, 4-25, 4-58, 4-59
 - Annex P, 4-58, 4-60
 - Annex V, 4-58, 4-62 through 4-64, 5-9, 5-13, 5-42
 - area study, 2-58, 4-17, 4-46, 4-47, 4-50
 - Army Special Operations Forces (ARSOFF), A-12, A-14, C-3, C-7, C-10, C-12
 - assessments, 1-24, 2-27, 2-34, 2-51, 2-56, 2-63, 2-66, 2-91, 2-121, 2-122, 4-10, 4-16, 4-22, 4-43, 4-48, 4-50 through 4-52, 4-74, 4-79, 5-47, 5-62, 5-57, B-3, B-5, B-7, B-10, B-14, B-15, B-17, B-20, B-21, B-23 through B-25, C-6
- B**
- branch characteristics, 1-38
 - branch principles, 1-39
- C**
- Civil Affairs operations (CAO), 1-1 through 1-5, 1-8, 1-16, 1-17, 1-19, 1-22, 1-33, 1-37, 1-38, 1-40, 1-43, 1-46, 2-1, 2-2, 2-5, 2-16, 2-18, 2-27, 2-32, 2-39, 2-52, 2-60, 2-71, 2-73, 2-87, 2-88, 2-97, 2-106, 2-107, 2-114, 2-115, 2-117, 3-4, 3-8, 3-12, 3-15, 3-17, 3-21, 3-23, 3-25, 3-27 through 3-29, 3-31, 3-35, 3-61, 3-72 through 3-74, 3-76, 3-82, 3-83, 4-2, 4-4, 4-5, 4-10 through 4-12, 4-17, 4-21 through 4-29, 4-32, 4-33-4-36, 4-38, 4-45, 4-47, 4-50 through 4-52, 4-54 through 4-59, 4-67, 4-72 through 4-75, 4-78, 4-85, 4-99, 4-102, 4-1018, 4-111 through 4-113, 4-115, 4-116, 4-118, 4-120, 4-127, 4-130, 5-15, 5-20 through 5-22, 5-46, 5-67 through 5-70, 5-75, C-1, C-4, C-9, C-11, C-12, C-14, C-16
 - Civil Affairs planning team (CAPT), 2-39, 4-24, 4-27, 4-28, 5-11, 5-24, D-11
 - civil engagement (CE), 1-23, 1-26, 1-27, 1-30, 1-46, 2-14, 2-58, 2-62, 2-63, 2-65, 2-66, 2-68, 2-67, 2-69, 2-71, 2-86, 2-88, 2-91, 2-96, 2-98, 2-99, 3-23, 3-25, 3-31, 3-61, 3-62, 3-70, 4-16, 4-22, 4-44, 4-45, 4-74, 4-79, 4-85, 4-108, 4-10, 4-14, 5-20, 5-21, 5-75, C-7, C-11, C-12, C-14, D-17, D-19
 - civil-military integration (CMI), 1-14, 1-16, 1-21, 1-29, 1-32, 1-33, 2-22, 2-32, 2-50, 2-106 through 2-108, 2-111, 2-115, 2-122, 3-6 through 3-8, 3-11, 3-12, 3-15, 3-29, 3-31, 3-65, 4-23, 4-24, 4-26, 4-62, 4-66, 4-67, 4-70, 4-86, 4-94, 4-95, 4-100, 4-110, 4-111, 4-114, 4-130, 5-4, 5-8, 5-47, 5-51
 - civil-military operations (CMO), 1-19, 1-33, 2-115, 4-28, 4-30, 4-62, 4-120, 4-124, 4-133 through 4-136, 5-5, 5-8 through 5-16, 5-18, 5-75
 - civil-military operations center (CMOC), 1-21, 1-31 through 1-33, 2-107, 2-114, 2-115, 2-118, 2-122, 2-123, 3-62, 4-24, 4-25, 4-30, 4-61, 4-64, 4-113, 4-114, 4-117, 4-127, 4-135, 5-5, 5-9, 5-13, 5-16, 5-62
 - consolidate gains, 1-1, 1-28, 2-2, 2-16, 2-48, 2-49, 2-52, 2-76, 2-100, 2-120, 3-5, 3-13, 3-14, 3-53, 3-68, 4-43, C-6
 - core competencies, 1-1, 1-14 through 1-16, 1-22, 1-24, 1-27, 1-30, 1-40, 1-47, 2-15, 2-16, 2-32, 3-4, 3-6, 3-23, 3-25, 3-29, 3-31
 - counterinsurgency, 5-43
 - cyberspace, 3-16, 3-20, 3-21, 4-27, 5-72, 5-73, 5-75, A-13
- D**
- decisive action, 3-6, 3-8, 3-12, 3-15, 3-21
 - defense support of civil authorities (DSCA), 1-40, 3-21, 3-33 through 3-36, 3-61, 4-3, D-15
 - direct action, C-10, C-11, C-14
 - civil knowledge integration (CKI), 1-14, 1-16, 1-19, 1-20, 2-32, 2-73, 2-87, 2-88, 2-91, 2-92, 2-94, 2-97, 2-122, 3-6, 3-8, 3-11, 3-12, 3-15, 3-25, 3-62, 3-65, 4-5 through 4-7, 4-19, 4-22 through 4-24, 4-40, 4-42, 4-45, 4-54, 4-67, 4-70, 4-72, 4-75, 4-79, 4-130, 5-4, 5-20, 5-47
 - civil network analysis (CNA), 2-72, 4-44, 4-72, 4-127
 - civil network development (CND), 1-23, 1-28 through 1-30, 2-58, 2-69, 2-71, 2-78, 2-88, 2-91, 2-96, 2-98, 2-92, 3-23, 3-70, 4-44, 4-45, 4-79, 4-85, 4-111, 5-75, C-12, C-14, D-17, D-18
 - civil network development and engagement (CNDE), 1-14, 1-16, 1-18, 1-20, 1-26, 1-29, 1-32, 2-10, 2-32, 2-51, 2-52, 2-54, 2-55, 2-61, 2-122, 3-3, 3-6 through 3-8, 3-11, 3-12, 3-15, 3-23, 3-25, 3-29, 3-31, 3-39, 3-47, 3-53, 3-55, 3-62, 3-65, 4-5, 4-6, 4-10, 4-23, 4-24, 4-66, 4-67, 4-70, 4-71, 4-86, 4-94, 4-95, 4-98, 4-100, 4-120, 4-130, 5-20, 5-47, 5-51, 5-63, C-7
 - civil preparation of the battlefield (CPB), 2-88, 3-30, 4-9, 4-10, 4-32
 - civil reconnaissance (CR), 1-23 through 1-25, 1-30, 2-14, 2-58, 2-62 through 2-66, 2-69, 2-71, 2-86, 2-88, 2-91, 2-96, 2-98, 2-99, 3-7, 3-23, 3-25, 3-31, 3-62, 3-70, 4-16, 4-22, 4-44, 4-74, 4-79, 4-85, 4-108, 4-10, 4-14, 5-20, 5-21, 5-75, C-7, C-11, C-12, C-14, D-17, D-19

F

foreign humanitarian
 assistance (FHA), 1-8, 2-35,
 2-48, 2-122, 3-50, 4-32,
 4-135, 5-9, 5-55, 5-43, 5-44,
 5-50, 5-56, 5-59, 5-60, 5-62
 through 5-65
 foreign internal defense (FID),
 2-47, 5-43, 5-44, 5-47, 5-66
 through 5-68, 5-70
 functional specialty areas,
 2-51, B-1, B-24

I

indigenous populations and
 institutions (IPI), 1-10, 1-21,
 1-30, 1-31, 1-38, 1-39, 1-43,
 1-45, 2-4, 2-15, 2-51, 2-83,
 2-99, 2-114, 2-118 through
 2-120, 3-7, 3-17, 3-21, 3-31,
 3-37, 3-48, 3-70, 3-75, 4-26,
 4-32, 4-33, 4-61, 4-113,
 4-134, 5-8, 5-9, 5-13, 5-14,
 5-19, 5-20, 5-22, 5-29, 5-46,
 5-62, 5-75, C-17
 information collection, 1-20,
 1-30, 2-14, 2-58, 2-63, 2-69,
 2-92, 2-94, 2-96, 2-97, 2-98,
 3-7, 3-11, 3-70, 4-7, 4-15,
 4-17, 4-26, 4-43 through
 4-45, 4-50, 4-59, 4-67, 4-82

M

mission variables, 2-89, 3-23,
 3-25, 3-31, 4-11, 4-12, 4-26,
 4-34, 4-38

O

offense, 1-40, 2-116, 3-12,
 3-21, through 3-23, 4-81

operational variables, 2-89,
 4-10, 4-12, 4-27, 4-28, 4-34,
 4-39, 4-40, 4-82

P

populace and resources control
 (PRC), 2-35, 2-83, 2-118,
 2-122, 3-15, 3-23, 3-25,
 3-31, 3-37 through 3-40,
 3-60, 4-80, 4-81, 4-85, 4-98
 through 4-100, 4-135, 5-9
 Psychological Operations
 (PSYOP), 3-72, 3-75, 3-76,
 4-74, 5-16, A-12

R

rules of allocation, 4-103, 4-105
 running estimate, 4-54, 4-56,
 4-57

S

shape, 1-18, 1-20, 1-43, 2-61,
 3-5, 3-8, 3-77, 4-26, 4-38,
 5-7, 5-12, 5-19, 5-20, C-17,
 D-12 through D-15
 support to civil administration
 (SCA), 1-23, 1-34, 2-15,
 2-20, 2-22, 2-33 through
 2-35, 2-41, 2-42, 2-46,
 through 2-51, 2-77, 2-115,
 2-122, 3-8, 3-15, 3-31, 3-45,
 3-62, 4-71, 4-98, 4-108,
 5-43, 5-49, 5-69, 5-74, 5-75,
 C-7

T

transitional governance (TG),
 1-14, 1-16, 1-17, 1-29, 1-33,
 2-15, 2-20 through 2-22,
 2-26, 2-27, 2-30 through

2-33, 2-38, 2-42, 2-51, 2-81,
 2-115, 2-119, 2-122, 3-6
 through 3-8, 3-11, 3-12,
 3-15, 3-18, 3-29, 3-53, 3-65,
 3-66, 4-24, 4-70, 4-130, 5-4,
 5-47, C-4, C-8

transitional military authority,
 1-23, 1-35 through 1-37,
 2-20, 2-22, 2-38, through
 2-44, 2-50, 2-115, 3-15,
 3-31, 3-60, 4-71, 4-135, 5-9,
 5-75, B-1

U

unconventional warfare (UW),
 A-10, C-3, C-4, C-9
 unified action, 1-13, 1-15, 1-19,
 1-21, 1-26, 1-31, 1-32, 1-38,
 1-39, 1-43, 1-47, 2-15, 2-25,
 2-50, 2-57, 2-68, 2-70, 2-75,
 2-78, 2-87, 2-88, 2-92, 2-94,
 2-106, 2-107, 2-114, 2-115,
 3-7, 3-8, 3-12, 3-27, 3-31,
 3-70, 3-71, 3-75, 4-8, 4-16,
 4-24, 4-26, 4-32, 4-40, 4-67,
 4-84, 4-97, 4-121, 5-1, 5-4,
 5-8, 5-13, 5-19, 5-20, 5-21,
 5-29, 5-46, 5-52, 5-75, C-17
 unified land operations, 1-6,
 2-115, 2-116, 2-122, 3-5,
 3-6, 3-21, 4-1, 4-55, 4-65
 unity of effort, 1-16, 1-21, 1-38,
 1-47, 2-67, 2-70, 2-106,
 2-110, 3-7, 3-42, 3-71, 3-72,
 4-5, 4-26, 4-62, 4-66, 4-67,
 4-70, 5-2, 5-4, 5-8, 5-20,
 5-23

FM 3-57
28 July 2021

By Order of the Secretary of the Army:

JAMES C. MCCONVILLE
General, United States Army
Chief of Staff

Official:



KATHLEEN S. MILLER
Administrative Assistant
to the Secretary of the Army
2120401

DISTRIBUTION:

Active Army, Army National Guard, and United States Army Reserve: Distributed in electronic media only(EMO).

PIN: 102337-000