

---

---

**CASUALTY EVACUATION**

---

---

**JUNE 2021**

**DISTRIBUTION RESTRICTION:** Approved for public release; distribution is unlimited.

This publication supersedes ATP 4-25.13, dated 15 February 2013.

---

---

**Headquarters, Department of the Army**

---

---

This publication is available at the Army Publishing Directorate site (<https://www.armypubs.mil>) and the Central Army Registry site (<https://atiam.train.army.mil/catalog/dashboard>).

# Casualty Evacuation

## Contents

	Page
<b>PREFACE</b> .....	vii
<b>INTRODUCTION</b> .....	ix
<b>Chapter 1 CASUALTY EVACUATION</b> .....	<b>1-1</b>
<b>Section I – Casualty Evacuation and the Army Health System</b> .....	<b>1-1</b>
Casualty Evacuation Capabilities .....	1-1
Casualty Evacuation Supports the Army Health System .....	1-2
<b>Section II – Command Responsibility and Planning</b> .....	<b>1-3</b>
Casualty Evacuation Planning.....	1-3
Company and Troop Level Casualty Evacuation .....	1-5
Platoon Level Casualty Evacuation Planning.....	1-6
<b>Section III – Casualty Training And Rehearsals</b> .....	<b>1-7</b>
<b>Section IV – Casualty Collection Points</b> .....	<b>1-8</b>
<b>Chapter 2 MANUAL EVACUATION METHODS</b> .....	<b>2-1</b>
Casualty Handling .....	2-1
Manual Carries .....	2-3
Drags .....	2-11
<b>Chapter 3 LITTER EVACUATION</b> .....	<b>3-1</b>
Standard Litters .....	3-1
Improvised Litters .....	3-8
<b>Chapter 4 CASUALTY EVACUATION PLATFORMS</b> .....	<b>4-1</b>
<b>Section I – Ground Vehicles Used for Casualty Evacuation</b> .....	<b>4-1</b>
Nonmedical Wheeled Vehicles.....	4-1
All-Terrain Utility Vehicles.....	4-10
<b>Section II – Army Nonmedical Aircraft</b> .....	<b>4-11</b>
Army Fixed-Wing Aircraft.....	4-11
Army Rotary-Wing Aircraft.....	4-12
<b>Section III – Army Watercraft</b> .....	<b>4-15</b>
Logistics Support Vessel .....	4-16
Landing Craft, Utility 2000 .....	4-17
Landing Craft, Mechanized 8.....	4-18
Small Tug 900 .....	4-18
Large Tug .....	4-19
Modular Causeway Systems .....	4-19

---

**DISTRIBUTION RESTRICTION:** Approved for public release; distribution is unlimited.

\*This publication supersedes ATP 4-25.13, dated 15 February 2013.

## Contents

---

	Warping Tug.....	4-19
	<b>Section IV – Alternative Platforms .....</b>	<b>4-20</b>
	Evacuation by Rail .....	4-20
	Evacuation by Bus .....	4-20
	Casualty Evacuation Using Contracted Agencies .....	4-21
<b>Chapter 5</b>	<b>ROUGH TERRAIN CONSIDERATIONS .....</b>	<b>5-1</b>
	Rough Terrain .....	5-1
	Rough Terrain Planning Considerations .....	5-2
	Techniques for Negotiating Hazards During Casualty Evacuation .....	5-3
<b>Chapter 6</b>	<b>CASUALTY EVACUATION IN SPECIFIC ENVIRONMENTS .....</b>	<b>6-1</b>
	Mountainous Terrain .....	6-1
	Jungle Terrain .....	6-1
	Desert Terrain .....	6-2
	Extreme Cold .....	6-2
	Urban Terrain .....	6-4
<b>Chapter 7</b>	<b>CASUALTY EVACUATION IN MASS CASUALTY SITUATIONS.....</b>	<b>7-1</b>
	Mass Casualty Situations.....	7-1
	Casualty Management .....	7-3
<b>Appendix A</b>	<b>EXAMPLE OF A MASS CASUALTY PLAN .....</b>	<b>A-1</b>
<b>Appendix B</b>	<b>LITTER EVACUATION TRAINING .....</b>	<b>B-1</b>
	Procedures for Litter Evacuation Training .....	B-1
<b>Appendix C</b>	<b>9-LINE MEDICAL EVACUATION REQUEST .....</b>	<b>C-1</b>
<b>Appendix D</b>	<b>CASUALTY EVACUATION CHECKLIST .....</b>	<b>D-1</b>
	<b>GLOSSARY .....</b>	<b>Glossary-1</b>
	<b>REFERENCES.....</b>	<b>References-1</b>
	<b>INDEX .....</b>	<b>Index-1</b>

## Figures

Figure 1-1. Casualty evacuation card .....	1-5
Figure 1-2. Company casualty collection point.....	1-9
Figure 1-3. Company casualty collection point in urban terrain.....	1-10
Figure 2-1. Positioning the casualty on their abdomen .....	2-3
Figure 2-2. Fireman’s carry.....	2-4
Figure 2-3. Fireman’s carry (alternate method for lifting the patient to a standing position) .....	2-5
Figure 2-4. Supporting carry .....	2-5
Figure 2-5. Arms carry .....	2-6
Figure 2-6. Saddleback carry.....	2-7
Figure 2-7. Pack-strap carry .....	2-8
Figure 2-8. Two-man supporting carry.....	2-8
Figure 2-9. Two-man arms carry .....	2-9
Figure 2-10. Two-man fore-and-aft carry.....	2-10
Figure 2-11. Four-hand seat carry .....	2-10
Figure 2-12. Two-hand seat carry.....	2-11

Figure 2-13. Personnel drag.....	2-12
Figure 2-14. Neck drag.....	2-12
Figure 2-15. Cradle-drop drag.....	2-13
Figure 3-1. Standard collapsible litter.....	3-2
Figure 3-2. Rigid pole folding litter .....	3-2
Figure 3-3. Adjustable handle rigid pole folding litter .....	3-3
Figure 3-4. Decontamination mass casualty litter .....	3-3
Figure 3-5. Folding rigid litter.....	3-4
Figure 3-6. Portable lightweight compact litter .....	3-4
Figure 3-7. Poleless nonrigid litter.....	3-5
Figure 3-8. Rescue and transport system/nonrigid litter .....	3-5
Figure 3-9. Spine board.....	3-6
Figure 3-10. Positioning of hands.....	3-6
Figure 3-11. Positioning of litter bearers .....	3-7
Figure 3-12. Positioning of litter straps.....	3-8
Figure 3-13. Patient securing strap .....	3-8
Figure 3-14. Litter made with blankets and poles .....	3-9
Figure 3-15. Litter improvised from jackets and poles .....	3-9
Figure 3-16. Litter improvised from sacks and poles .....	3-10
Figure 3-17. Rolled blanket litter .....	3-10
Figure 3-18. Rolled blanket used as a litter.....	3-10
Figure 3-19. Travois litter .....	3-11
Figure 3-20. Suspended litter .....	3-12
Figure 4-1. M998 truck, cargo/troop carrier 1 1/4-ton, high-mobility multipurpose vehicle (four-person configuration), with three litters.....	4-2
Figure 4-2. M998 truck, cargo/troop carrier 1 1/4-ton, high-mobility multipurpose wheeled vehicle (two-person configuration), with five litters .....	4-3
Figure 4-3. Loading the M1093, medium tactical vehicle, 5 ton.....	4-4
Figure 4-4. Loading the M1081, light medium tactical vehicle, 2 1/2-ton.....	4-5
Figure 4-5. M977 Heavy expanded, mobility tactical truck, 8 x 8, cargo.....	4-6
Figure 4-6. M1075A1, Palletized Load System .....	4-6
Figure 4-7. M871, 22 1/2-ton, cargo semitrailer, loaded with litters .....	4-7
Figure 4-8. Mine-resistant ambush protected vehicle .....	4-8
Figure 4-9. M-1126 Stryker infantry carrier vehicle .....	4-9
Figure 4-10. Joint light tactical vehicle .....	4-10
Figure 4-11. Military utility vehicle .....	4-10
Figure 4-12. Cargo-12 Huron .....	4-11
Figure 4-13. Cargo 26-Metroliner .....	4-11
Figure 4-14. Utility Cargo-35 Citation .....	4-12
Figure 4-15. Interior view of Cargo Helicopter-47 (Chinook) with seat installation .....	4-13
Figure 4-16. Interior view of Cargo Helicopter-47 (Chinook) with litter installation .....	4-13
Figure 4-17. Utility Helicopter-60 (Blackhawk).....	4-14

## Contents

---

Figure 4-18. Light Utility Helicopter-72 Lakota .....	4-15
Figure 4-19. Logistics support vessel .....	4-16
Figure 4-20. Example of a Logistics support vessel with litters .....	4-17
Figure 4-21. Landing craft, utility 2000 .....	4-17
Figure 4-22. Example of landing craft utility 2000, with litters .....	4-18
Figure 4-23. Landing craft, mechanized 8 .....	4-18
Figure 4-24. Causeway ferry.....	4-19
Figure 4-25. Warping tug .....	4-19
Figure 5-1. Casualty packaging .....	5-4
Figure 5-2. High angle casualty evacuation.....	5-5
Figure 5-3. Low angle casualty evacuation .....	5-7
Figure 5-4. Steep angle casualty evacuation.....	5-8
Figure A-1. Example of a mass casualty standard operations plan .....	A-1
Figure B-1. Carrying litter at high port.....	B-2
Figure B-2. Litter squad with litter .....	B-3
Figure B-3. Grounding litter (position on ground, litter) .....	B-3
Figure B-4. Grounding litter (position of litter, POSTS) .....	B-4
Figure B-5. Opening litter (step one) .....	B-4
Figure B-6. Opening litter (step two).....	B-5
Figure B-7. Squad at right side, POSTS.....	B-6
Figure B-8. Lifting patient to hold litter (step one).....	B-6
Figure B-9. Lifting patient to load litter (step two) .....	B-7
Figure B-10. Lifting patient to load litter (step three) .....	B-7
Figure B-11. Lowering patient to load litter (three bearers).....	B-8
Figure B-12. Lowering patient onto litter (three bearers).....	B-8
Figure B-13. Two bearers at right side, POSTS .....	B-9
Figure B-14. Lifting patient with two bearers on the same side.....	B-9
Figure B-15. Lifting patient with two bearers on the same side (step two).....	B-10
Figure B-16. Lowering patient onto litter with two bearers on the same side.....	B-10
Figure B-17. Two bearers, one on each side, POSTS .....	B-11
Figure B-18. Lifting patient with two bearers, one on each side (step one) .....	B-11
Figure B-19. Lifting patient with two bearers, one on each side (step two).....	B-12
Figure B-20. Lowering patient onto litter (two bearers, one on each side).....	B-12
Figure B-21. Lifting patient with back injury .....	B-13
Figure B-22. Lifting the loaded litter .....	B-14
Figure B-23. Four-man carry for smooth, level terrain.....	B-14
Figure B-24. Two-man carry for smooth, level terrain .....	B-15
Figure B-25. Litter post carry for rough terrain .....	B-16
Figure B-26. Rotation of the litter for uphill and upstairs carry and for ambulance loading.....	B-17
Figure B-27. Uphill and upstairs carry .....	B-17
Figure B-28. Downhill or downstairs carry.....	B-18

Figure B-29. Surmounting a fence or low wall (step one) .....B-19  
Figure B-30. Surmounting a fence or low wall (step two) .....B-20  
Figure B-31. Surmounting a high wall .....B-20  
Figure B-32. Forging streams and crossing deep trenches (overhead carry, step one).....B-21  
Figure B-33. Forging streams and crossing deep trenches (overhead carry, step two).....B-22  
Figure B-34. Carrying a litter patient up a stairwell with small landings.....B-23  
Figure B-35. Carrying a liter patient down a stairwell with small landings .....B-24

## **Tables**

Introductory Table-1. Army terms..... x  
Table 4-1. Litter and ambulatory configuration of the Cargo Helicopter-47 (Chinook) ..... 4-14  
Table 7-1. Categories of evacuation precedence ..... 7-3  
Table C-1. 9-line medical evacuation request..... C-1  
Table D-1. Casualty evacuation checklist ..... D-1

This page intentionally left blank.



## Preface

This Army Techniques Publication 4-02.13 provides doctrine and techniques for conducting casualty evacuation. Casualty evacuation encompasses both the evacuation of Soldiers from the point of injury to a medical treatment facility and the coordination requirements for the use of nonmedical transportation assets to accomplish the casualty evacuation mission. In addition, it discusses the differences between casualty evacuation and medical evacuation, identifies casualty evacuation as a commander's responsibility, and addresses planning and training for casualty evacuation operations.

The principal audience for Army Techniques Publication 4-02.13 is all members of the profession of arms. Commanders, their staff, and leaders at all levels should refer to this publication regarding the planning, training, equipping, and execution of casualty evacuation operations and techniques.

Commanders, staffs, and subordinates ensure that their decisions and actions comply with applicable United States, international, and in some cases host-nation laws and regulations. Commanders at all levels ensure that their Soldiers operate in accordance with the law of war and the rules of engagement. (See Field Manual 6-27).

This publication implements or is in consonance with the following North Atlantic Treaty Organization and International Standardization Agreements:

<b>TITLE</b>	<b>NATO STANAGs</b>
<i>Stretchers, Bearing Brackets, and Attachment Supports—Allied Medical Publication-2.1</i>	2040
<i>Aeromedical Evacuation—Allied Aeromedical Publication-1.1</i>	3204

Army Techniques Publication 4-02.13 uses joint terms where applicable. Selected joint and Army terms and definitions appear in both the glossary and the text. Terms for which Army Techniques Publication 4-02.13 is the proponent publication (the authority) are italicized in the text and are marked with an asterisk (\*) in the glossary. Terms and definitions for which Army Techniques Publication 4-02.13 is the proponent publication are boldfaced in the text. For other definitions shown in the text, the term is italicized and the number of the proponent publication follows the definition.

Army Techniques Publication 4-02.13 applies to the Active Army, Army National Guard/Army National Guard of the United States and United States Army Reserve unless otherwise stated.

The proponent and preparing agency for Army Techniques Publication 4-02.13 is the United States Army Medical Center of Excellence, Doctrine Literature Division. Send comments and recommendations on a Department of the Army Form 2028 (*Recommended Changes to Publications and Blank Forms*) to Commander, United States Army Medical Center of Excellence, ATTN: ATMC-FD (Army Techniques Publication 4-02.13), 2377 Greeley Road, Building 4011, Suite B, Fort Sam Houston, Texas 78234-7731; by e-mail to [usarmy.jbsa.medical-coe.mbx.ameddcs-medical-doctrine@mail.mil](mailto:usarmy.jbsa.medical-coe.mbx.ameddcs-medical-doctrine@mail.mil). All recommended changes should be keyed to a specific page, paragraph, and line number. A rationale for each proposed change is required to aid in the evaluation and adjudication of each comment.

This page intentionally left blank.

# Introduction

Army Techniques Publication 4-02.13 is consistent with Field Manual 4-02 while adopting concepts as necessary and updating terminology. Casualty evacuation involves the unregulated movement of casualties using predesignated or opportune tactical or logistical aircraft and vehicles. These vehicles are not staffed with medical personnel for en route care (unless augmentation is planned for in the operation plan). These vehicles do not have organic medical equipment. If the combat medic is not available to provide en route care, the combat lifesaver may accompany the casualties to monitor their conditions. Casualty evacuation is oftentimes the first step in a process that moves a wounded or injured Soldier from the point of injury into the multifaceted Army Health System. Casualty evacuation can be accomplished by a variety of transportation platforms. These methods must be trained and practiced and include manual carries, litter evacuation, and the use of nonmedical vehicles. The movement of a casualty begins the evacuation chain which clears the operational area of casualties and moves them through successively enhanced roles of medical care.

## WARNING

**Casualties transported in this manner may not receive proper en route medical care or be transported to the appropriate medical treatment facility to address the patient's medical condition. If the casualty's medical condition deteriorates during transport, or the casualty is not transported to the appropriate medical treatment facility, an adverse impact on the prognosis and long-term disability or death may result.**

Summary of changes include—

- Reorganizing the numbering of the publication to Army Techniques Publication 4-02.13 to align with other medical doctrine publications.
- Reorganizing the order of the publication.
- Designating this publication as the proponent for casualty evacuation for which Field Manual 4-02 was previously the proponent. (See introductory table-1 on page x.)
- Addressing casualty evacuation as a commander's responsibility as well as casual evacuation planning.
- Adding other Army casualty evacuation platforms and addressing the use of nonmilitary vehicles for casualty evacuation.
- Adding information regarding casualty evacuation in rough terrain.

Army Techniques Publication 4-02.13 contains seven chapters and three appendixes as follows:

**Chapter 1** provides an overview of casualty evacuation and the Army Health System. It discusses casualty evacuation as a command responsibility and addresses planning, training, and equipping considerations.

**Chapter 2** describes techniques and procedures for manual evacuation methods including one-and two-man carries as well as drags.

**Chapter 3** describes techniques and procedures for casualty evacuation utilizing both standard litters and improvised litters.

**Chapter 4** discusses casualty evacuation platforms and provides techniques and procedures for Army ground vehicles, fixed-and rotary-wing aircraft, and watercraft.

**Chapter 5** addresses casualty evacuation considerations and techniques for negotiating rough terrain.

**Chapter 6** discusses insights to casualty evacuations in specific environments.

**Chapter 7** provides considerations for casualty evacuations in mass casualty situations.

**Appendix A** provides an example of a mass casualty plan.

**Appendix B** discusses and provides procedures for litter evacuation training to be used to train nonmedical personnel on the proper techniques for loading, carrying, and unloading litter patients through a variety of environments.

**Appendix C** provides an example of a 9-line medical evacuation request.

**Appendix D** provides an example of a casualty evacuation checklist.

Based on doctrinal changes, the term for which Army Techniques Publication 4-02.13 is the proponent has been added for the purposes of this publication. The glossary contains acronyms and defined terms. (See introductory table-1 for specific term changes.)

**Introductory Table-1. Army terms**

<b>Term</b>	<b>Remark</b>
casualty evacuation	ATP 4-02.13 is now the proponent

# Chapter 1

## Casualty Evacuation

While casualty evacuation (CASEVAC) supports and augments medical evacuation (MEDEVAC) capabilities, CASEVAC is not a part of the Army Health System. Casualty evacuation is a commander's responsibility that may be the first in a series of steps of moving a casualty from the point of injury (POI) through the medical evacuation system. Refer to Army Techniques Publication (ATP) 4-02.2 for information on medical evacuation.

### SECTION I – CASUALTY EVACUATION AND THE ARMY HEALTH SYSTEM

1-1. Leaders and Soldiers must understand what CASEVAC is, the advantages and limitations of using CASEVAC, and how it supports the Army Health System.

#### CASUALTY EVACUATION CAPABILITIES

1-2. Casualty evacuation must not be confused with MEDEVAC. **Casualty evacuation is the movement of casualties aboard nonmedical vehicles or aircraft without en route medical care.** A *casualty* is any person who is lost to the organization by having been declared dead, duty status—whereabouts unknown, missing, ill, or injured (Joint Publication [JP 4-02]). Casualty evacuation may be preplanned in support of a specific operation or may be by opportunity, such as when a cargo vehicle delivers ammunition and backhauls casualties.

1-3. *Medical evacuation* is the timely and effective movement of the wounded, injured, or ill to and between medical treatment facilities on dedicated and properly marked medical platforms with en route care provided by medical personnel (ATP 4-02.2). A *patient* is defined as a sick, injured, or wounded Soldier who receives medical care or treatment from medically trained personnel (Field Manual [FM 4-02]). The MEDEVAC ambulances are dedicated to conducting the MEDEVAC mission and providing emergency. Class VIII resupply. There are no competing requirements for the MEDEVAC vehicles however, ground and air ambulances are a low density, high demand asset. As a result, MEDEVAC vehicles may be overwhelmed when casualty numbers exceed available capacity.

1-4. Medical evacuation ambulances are properly marked and afforded protections in accordance with the Geneva Conventions and the Law of War. Due to these laws, medical evacuation ambulances are not equipped with crew served weapons. However, CASEVAC vehicles may be equipped in this manner because they are not limited by the Geneva Conventions and the Law of War. Without these constraints, CASEVAC vehicles may be armed for protection against enemy personnel and vehicles. Casualty evacuation vehicles equipped with crew served weapons may serve as escort vehicles for MEDEVAC ambulances thereby, providing both increased security and additional evacuation capabilities. Refer to FM 6-27/MCTP 11-10C for information on actions that do not deprive medical units or transports of their protection.

1-5. There are several limitations when using CASEVAC instead of MEDEVAC. Limitations to CASEVAC include:

- En route care is not provided unless it has been preplanned and staffed.
- The CASEVAC vehicle lacks the medical equipment suite typical of a MEDEVAC ambulance.
- Lack of space may prevent an accompanying combat lifesaver or combat medic the space needed to perform lifesaving interventions; even monitoring may be impeded.

- A CASEVAC vehicle is not a dedicated evacuation platform and has competing requirements (for example, the movement of ammunition or water). As a result, a CASEVAC vehicle may not be readily available but committed elsewhere.
- The CASEVAC vehicle lacks the protections afforded to properly marked MEDEVAC ambulances in accordance with the Geneva Conventions (I) and the Law of War.

### **PLANNED AND UNPLANNED CASUALTY EVACUATION**

1-6. The difference between planned and unplanned CASEVAC is preparation, availability of personnel, capability, and equipment. A planned CASEVAC operation is deliberate where dedicated evacuation vehicles have been identified, configured for CASEVAC operations, assigned crews, and are prepared to provide quick CASEVAC support. Medical personnel and combat lifesavers may be requisitioned and assigned to dedicated and designated CASEVAC vehicles. Medical supplies are provided for en route treatment whenever possible.

1-7. Unplanned CASEVAC is conducted with whatever personnel or vehicles are immediately available and may be used as a platform of opportunity. It is often a matter of necessity where the tactical situation permits personnel and vehicles to quickly remove the casualty from immediate danger. Unplanned CASEVAC has the highest risk of causing further injury to the casualty.

### **LEVELS OF CASUALTY EVACUATION SUPPORT**

1-8. There are three levels of CASEVAC support with varying degrees of support and planning requirements. The levels of CASEVAC are—

- **Dedicated CASEVAC.** Dedicated CASEVAC consists of vehicles and crews trained, equipped, and are reserved exclusively for a CASEVAC mission. Dedicated CASEVAC support requires planning and integration into unit and staff rehearsals, and is used when casualty rates are estimated to exceed MEDEVAC capabilities.
- **Designated CASEVAC.** Designated CASEVAC consists of vehicles and crews who serve in other roles but are also tasked to provide CASEVAC as a contingency. The designated CASEVAC crew may be tasked for a specific phase, time, or mission.
- **Platform of Opportunity.** A platform of opportunity may be conducted by any vehicle when the situation necessitates CASEVAC and the tactical situation permits. A platform of opportunity vehicle is not configured, equipped, and crewed for the purpose of CASEVAC and as a result, it has the highest risk of morbidity and mortality and possibly increases long-term disability to the casualty.

### **CASUALTY EVACUATION SUPPORTS THE ARMY HEALTH SYSTEM**

1-9. Casualty evacuation supports the Army Health System by providing a means to augment the capacity of MEDEVAC ambulances. A CASEVAC vehicle may be where a wounded Soldier enters the evacuation system. Commanders and staff consider medical evacuation requirements in an operation, especially where higher casualties are expected and provide augmentation with CASEVAC vehicles when available.

1-10. During large-scale combat operations, CASEVAC vehicles may be used to move casualties from POI to casualty collection points (CCPs) or from CCPs to an ambulance exchange point (AXP) or battalion aid station (BAS). This use of CASEVAC vehicles is likely in contested areas such as drop zones, landing zones (LZs), during river crossings, and the breach of an enemy defense. In these situations, MEDEVAC may not yet be available, and the troop delivery vehicle may be used to move casualties from POI or CCP to an AXP, or a medical treatment facility (MTF) as it returns to transport more Soldiers and equipment. A *medical treatment facility* is (Joint) a facility established for the purpose of furnishing medical and/or dental care to eligible individuals. (FM 4-02). (Army) *Medical treatment facility* refers to any facility established for the purpose of providing medical treatment. This includes BASs, Role 2 facilities, dispensaries, clinics, and hospitals. (FM 4-02).

1-11. The use of CASEVAC may be required when the casualty numbers exceed MEDEVAC capabilities or where MEDEVAC ambulances cannot physically access casualties. In dense urban and subterranean environments, CASEVAC may consist of multiple litter teams to conduct manual and litter carries from POI to CCPs. This may include traversing through breached areas horizontally and vertically. Manual casualty evacuation may be utilized due to the constrained environment until the casualty reaches a location, CCP, or AXP where MEDEVAC ambulances can operate and further evacuate for medical care. Refer to ATP 3-21.51 for more information on subterranean operations.

1-12. When the use of CASEVAC vehicles is required because MEDEVAC ambulances are overwhelmed, casualty evacuation can be utilized to move the less injured or ill patients. A planned CASEVAC operation synchronized and nested with the MEDEVAC plan best supports this situation. This enables MEDEVAC ambulances to be more efficiently used in the transport of those more seriously injured or ill patients. This is an economic approach to the problem of clearing the battlefield to ensure commanders have freedom of maneuver and can sustain the initiative. An example of this is using MEDEVAC and CASEVAC to clear a Role 2 MTF in order to enable the unit to move forward and sustain proximity with supported Role 1 MTFs. Additionally, CASEVAC assets may be required and should prepare to perform emergency CL VIII resupply.

1-13. The MTFs (BAS; medical company, area support; medical company, brigade support; and field hospital) can sustain proximity with supported units by transferring its patients to another MTF, which may be accomplished using CASEVAC to move stable patients that medical personnel determine should not be further injured during movement to another MTF. The number of casualties may exceed the capacity of MEDEVAC ambulances to evacuate everyone in a timely manner to meet tactical requirements. Commanders and leaders analyze the potential need for CASEVAC, include it into plans, and rehearse CASEVAC standard operating procedures (SOPs).

## SECTION II – COMMAND RESPONSIBILITY AND PLANNING

1-14. In accordance with Section 3583, Title 10, United States Code (10 USC 3583), commanders are required to promote and safeguard the physical well-being of officers and enlisted personnel under their command or charge. Casualty evacuation supports this in the absence or in support of MEDEVAC. The planning for CASEVAC is the commander's responsibility. The commander's staff assists in this planning and in the synchronization of CASEVAC with the unit MEDEVAC plans, organic medical capabilities, the overall Army Health System support plan, and the sustainment support plan.

## CASUALTY EVACUATION PLANNING

1-15. During the military decision-making process and troop leading procedures, CASEVAC is planned parallel to MEDEVAC of the health service support plan. While CASEVAC is not a medical function, assigned or available medical personnel provide advice and input on the use of CASEVAC. Battalion level or higher staff utilizes the military decision making process, and small unit leaders use troop leading procedures to conduct mission analysis, plan for a mission, and prepare for an operation.

1-16. Casualty evacuation planning is executed through synchronization with the following assigned or attached staff sections, and personnel for the associated reasons:

- S-1 for casualty accountability plan and casualty estimates to understand possible requirements for CASEVAC. This will also inform staff of when MEDEVAC demands are expected to be highest in an operation.
- S-2 for intelligence estimates.
- S-3 to ensure the CASEVAC plan supports the overall plan and commander's intent.
- S-4 to synchronize CASEVAC with other sustainment plans and requirements. This helps identify times where the need for sustainment support is expected to be lower or greater, and when available, CASEVAC support may be limited or available in larger numbers.
- S-6 for command and control concerning frequencies and call signs.
- Chemical, biological, radiological, and nuclear personnel for planned contaminated routes and decontamination sites. This also includes consideration for CASEVAC litter teams designated to assist in patient decontamination.

- Air defense and fires, especially for the use of rotary-wing CASEVAC.
- Engineers for route trafficability, known and planned obstacles to include mines that may threaten or delay CASEVAC.
- Unit medical personnel (medical platoon leader, platoon sergeant, and surgeon) or other medical leadership from units providing direct or area support to synchronize CASEVAC with MEDEVAC plans. This includes planned locations for treatment teams A and B if the BAS is split, AXPs, primary and alternate evacuation routes, and helicopter LZs.
- Supporting lift and assault aviation personnel to determine available platform capabilities if rotary wing aircraft are to support CASEVAC. This includes litter kits if available.

1-17. The troop leading procedures are used to solve tactical problems. At a company level, commanders utilize the company first sergeant, executive officer, supply sergeant, and communications sergeant to assist during troop leading procedures as well as company assigned combat medics. Regardless of the echelon, CASEVAC operations are included as a battle drill for commanders and staff and rehearsed during unit training.

1-18. A CASEVAC plan augments limited organic and attached MEDEVAC capabilities, especially when estimates anticipate high casualties. The plan provides a basic description of how CASEVAC will be conducted including:

- Who is providing the CASEVAC support?
- What is the CASEVAC concept of support (can be depicted or described)?
- When is CASEVAC expected to be needed/vehicles and crews on stand-by?
- Where are the CASEVAC vehicles, CCPs, AXPs, and MTFs located?
- How will the casualties be evacuated (routes, LZs)?

1-19. The CASEVAC vehicle locations should be included with the MEDEVAC common operational picture. A method of organizing a CASEVAC plan onto a graphic aid is depicted in figure 1-1. Information includes a 9-line MEDEVAC request, graphic (which could be a grease pencil or alcohol pen drawn on white space) to depict the support plan, evacuation routes, available CASEVAC assets, and the location of CCPs, AXPs, and the BAS. This provides an example of “a way” to organize and depict a CASEVAC concept of support but not “the” way. Units organize their plans and graphic aids to best support their requirements and capabilities.



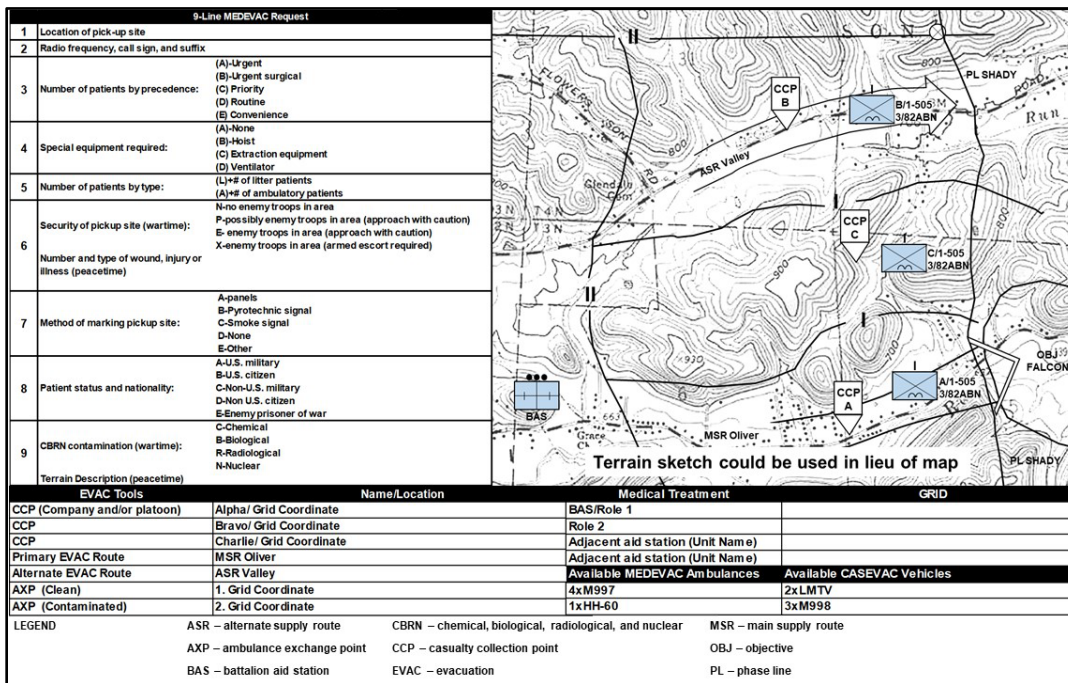

Figure 1-1. Casualty evacuation card

1-20. Planning for CASEVAC enhances the ability of the unit to accomplish its mission while providing care for those wounded and injured. Planning should address a number of variables such as the availability of equipment and transportation assets, available time to train and rehearse, and the cross training of personnel. Appendix D of this publication provides an example of a CASEVAC checklist.

1-21. A CASEVAC plan addresses specific environmental factors as they apply to the area of operations. The environmental effects on CASEVAC operations are similar to those of MEDEVAC. See ATP 4-02.2 for further information on medical evacuation in specific environments. Additional CASEVAC environment considerations are located in chapter 6 of this publication.

1-22. Planning CASEVAC for special operations is different primarily due to the potential for evacuation over extended distances, in denied environments, and in support of the unique nature of special operations missions such as foreign internal defense or unconventional warfare. Casualty evacuation support to special operations may have little to no planning time for conventional units and staff unless, special operations personnel provide notification of an impending mission and potential need to enable the unit to initiate planning and preparations. For more information regarding support to special operations forces, refer to ATP 4-02.43 and Training Circular (TC) 18-09.

## COMPANY AND TROOP LEVEL CASUALTY EVACUATION

1-23. The unit CASEVAC plan provides guidance to subordinate plans and synchronizes efforts. The plan describes how subordinate units support one another with CASEVAC and how to coordinate with other units within the same organization. It provides a method to support CASEVAC while remaining focused on achieving the mission.

1-24. Unit CASEVAC planning is included in small unit troop leading procedures. Support and combined arms rehearsals include synchronizing subordinate element CASEVAC actions, identifying problems, improving Soldier understanding of the concept of the operation, and how CASEVAC supports the operation.

1-25. Units utilize CASEVAC SOPs to reduce time required to address CASEVAC operations because the tactics, techniques, and procedures included in the SOP can be modified to support the plan and environment.

1-26. At the unit level, the CASEVAC SOP should include the critical information discussed in the subordinate level planning section but broader in scope, coordinated and nested with the higher unit's SOP, and synchronized with the health service support plan. This includes the maneuver battalion medical platoon, brigade support medical company, and other supporting medical units.

1-27. The SOP addresses mass casualty (MASCAL) situations and how CASEVAC supports the medical response to a MASCAL situation. This includes situations where medical support may only consist of a combat medic such as during vertical envelopments and amphibious assaults. In those circumstances where medical support is planned to increase as the initial lodgment is secured, the SOP must address the hand-off of responsibilities from CASEVAC to more robust medical capabilities and personnel.

1-28. The commander's assessment of the tactical situation and the availability of escort vehicles will determine if security escorts will accompany CASEVAC vehicles. The commander will weigh priorities to best allocate their finite resources and mitigate risk as much as practicable while executing their mission. A security escort will not always be available and using vehicles with mounted and manned crew served weapons can mitigate the risk but does not eliminate it. Factors that leaders must consider concerning security and CASEVAC include:

- Urgency of the need to evacuate.
- Current and planned friendly actions in the area of operations.
- Known enemy forces and activity in the area of operations.
- Probability that CASEVAC vehicles will be engaged by enemy forces, guerillas, or insurgents.
- Known or suspected bypassed enemy forces within the unit's area of operations.
- Security of evacuation route and friendly activity.

1-29. Even when security escorts accompany CASEVAC vehicles, it does not remove all risk. Imperial Japanese forces routinely targeted litter bearers conducting CASEVAC during World War II in the Pacific Theater, even though the Soldiers and Marines were armed and often had security with them. Commanders and leaders will mitigate risk whenever possible but the mission may take priority over providing escorts to CASEVAC.

1-30. The unit first sergeant has a significant role in the planning and execution of the unit's medical care, and oversees the CCP if necessary. The CCP should be selected based on mission variables and accessible by air and ground MEDEVAC and CASEVAC vehicles. Actions at the CCP must be incorporated into drills and rehearsals. For more information on CCP site selection, see ATP 4-02.2.

1-31. The commander, executive officer, or first sergeant ensures that platoon CASEVAC plans are synchronized with and support the unit SOP, units have sufficient numbers of qualified and current combat lifesaver trained personnel, Class VIII shortages are filled, and that vehicles are identified and marked. The commander and first sergeant ensure CASEVAC is regularly included in platoon and unit training.

## **PLATOON LEVEL CASUALTY EVACUATION PLANNING**

1-32. Developing a platoon level SOP for CASEVAC operations standardizes roles and responsibilities within the platoon, squads, and teams. It identifies critical capabilities that must be maintained (such as crew served weapon teams or radio operator) while identifying those that may be used to support CASEVAC.

1-33. Litter teams are established and equipped before an operation is begun. Designated litter teams and drivers are aware of the location of the CCPs, AXP, and MTFs and are capable of navigating there when needed. Vehicles should have at least one combat lifesaver trained Soldier as part of the crew whenever possible. Drivers and litter teams must be updated on changes to the locations of CCPs, AXP, or MTFs as soon as possible to avoid unnecessary delay in moving casualties, and exposing personnel unnecessarily to additional hazards.

1-34. Casualty evacuation using litter teams is physically demanding. Leaders must understand the physical demands and plan to swap out litter team members to sustain CASEVAC support if necessary. This also applies to situations where manual carriers are used instead of litters. Manual carries may be required due to

the tactical situation, limited number of litters, or ability of the casualty to move with assistance. Leaders will assess the tactical situation to choose the best means of CASEVAC.

1-35. Litter teams must be familiar with unit medical tactics, techniques, and procedures for CCPs including considerations like separate areas for killed in action, contaminated casualties, detainees, and civilians. This includes a security plan for enemy casualties and the disposition of enemy equipment.

1-36. Sensitive items such as weapons, maps, overlays, and communication equipment are considered unit equipment and secured if obtained from casualties to be left with the unit. Platoons will use a designated collection point for any carried cross-leveled medical supplies when necessary.

1-37. Consulting unit medical personnel during the development of the platoon SOP ensures platoon members are properly trained to load CASEVAC vehicles and that platoon CCPs are marked by priority in accordance with the medical treatment team's recommendations and triage category. Coordination between the platoon and the medical leadership should include the following:

- Points of contact, call signs, frequencies, and phone numbers.
- Primary, alternate, and "dirty" evacuation routes.
- Current and planned locations of MTFs and AXPs.
- Required equipment needed to evacuate casualties.
- Planned point or event in the operation when any of the information above is planned to change. An example of this is crossing a phase line or conducting a passage of lines.

## SECTION III – CASUALTY TRAINING AND REHEARSALS

1-38. Casualty evacuation plans and SOPs are only effective when combined with training and rehearsals. The training of CASEVAC is included in battle drills and unit training events to achieve proficiency with associated individual and collective tasks. Other tasks that support CASEVAC in addition to manual and litter carries described in this publication include:

- Conduct tactical combat casualty care.
- Link up with other tactical forces.
- Employ camouflage, concealment, and decoy techniques.
- Employ noise, light, thermal, and physical evidence controls.
- React to enemy direct and indirect fires.
- Navigate from one point to another.
- Conduct tactical convoy.
- Transmit a 9-line MEDEVAC request.

1-39. Training and rehearsing the manual and litter handling techniques located in this publication reduces the risk of causing further injury to the casualty, or to those personnel performing manual and litter carries as well as during the loading or unloading of CASEVAC ground and air vehicles or watercraft.

1-40. The operators of CASEVAC vehicles will be trained and licensed on their vehicle. Drivers are also briefed on considerations specific to the vehicles use as a CASEVAC platform. These considerations may reduce the potential of a casualty's condition deteriorating due to the manner in which the vehicle is configured and operated. Examples include the use of tie-down equipment on cargo vehicles or medical considerations such as the in-flight altitude when evacuating casualties with head trauma.

1-41. Drivers, combat lifesavers, and litter teams are predesignated to ensure personnel can respond quickly when needed with less confusion. Marking the vehicles helps identify its role as a CASEVAC platform and informs personnel of its priority for that mission. However, markings must not compromise concealment or draw undue enemy attention to the CASEVAC vehicle. The tactical situation must be considered before marking any vehicle.

1-42. Incorporating Army utility and cargo aviation assets into unit CASEVAC training is not always possible. In order to maximize time when limited aviation support is available, Soldiers are trained in advance on establishing a LZ, their actions in and around an aircraft, and loading or unloading techniques. Unit leaders can coordinate with supporting aviation units to conduct this training on the flight line with static

aircraft whenever possible. This increases Soldier proficiency and familiarity with the aircraft and reduces risk when conducting CASEVAC training with operating aircraft. Refer to FM 3-21.38 for detailed information on establishing and marking LZs.

1-43. Rehearsing CASEVAC helps prevent sensitive items from being lost, overlooked, or compromised. Items that need to remain with the platoon are identified and redistributed according to the need and the tactical situation. Items such as a chemical protective mask accompany the casualty during evacuation.

1-44. Medical personnel should be consulted and used to evaluate the movement of casualties to ensure litter teams are properly trained to prevent causing further injury to the casualty as well as prevent injuries from repeatedly lifting heavy weight. This also provides leaders and Soldiers with an understanding of how a work rest cycle should be utilized. Litter carries (standard and improvised) can be integrated into platoon physical fitness training as another means of reinforcing proper handling tactics, techniques, and procedures.

1-45. Rehearsing the movement of casualties from CCPs to BAS is important so that litter bearers understand how they integrate with and support the medical support plan. Rehearsals reinforce recommended methods in the loading, positioning, and securing of litter patients which reduces the time required and risk of causing further injury to the casualty.

1-46. Casualty evacuation should be included into unit chemical, biological, radiological, and nuclear training. Conducting CASEVAC in a contaminated environment is more challenging. Communication is hindered by the protective mask making coordination difficult. Moving casualties while wearing protective equipment increases physical stress and litter teams require more frequent rest. Leaders must consider water replacement and work rest cycles during training for CASEVAC in contaminated environments. Rehearsals will provide leadership with a better understanding of their unit's capability under contaminated conditions and build confidence in the Soldiers ability to operate under this increased stress. Refer to ATP 3-11.32/MCWP 10-10E.8/NTTP 3-11.37/AFTTP 3-2.46 for information regarding work, rest cycles, and water replacement guidelines.

## **SECTION IV – CASUALTY COLLECTION POINTS**

1-47. The movement of casualties to a CCP during combat operations is chaotic and stressful. Casualty collection points that are standardized, included into unit SOPs, and included during platoon and unit training events operate efficiently and reduce issues that may otherwise be encountered. Units develop CCP planning tools to assist in this while understanding that mission variables such as enemy, terrain, and weather will require modifications to the CCP layout. The following diagrams provide examples of how CCPs may be organized by a unit. A method for organizing a CCP outside in an open or wooded area is depicted in figure 1-2.

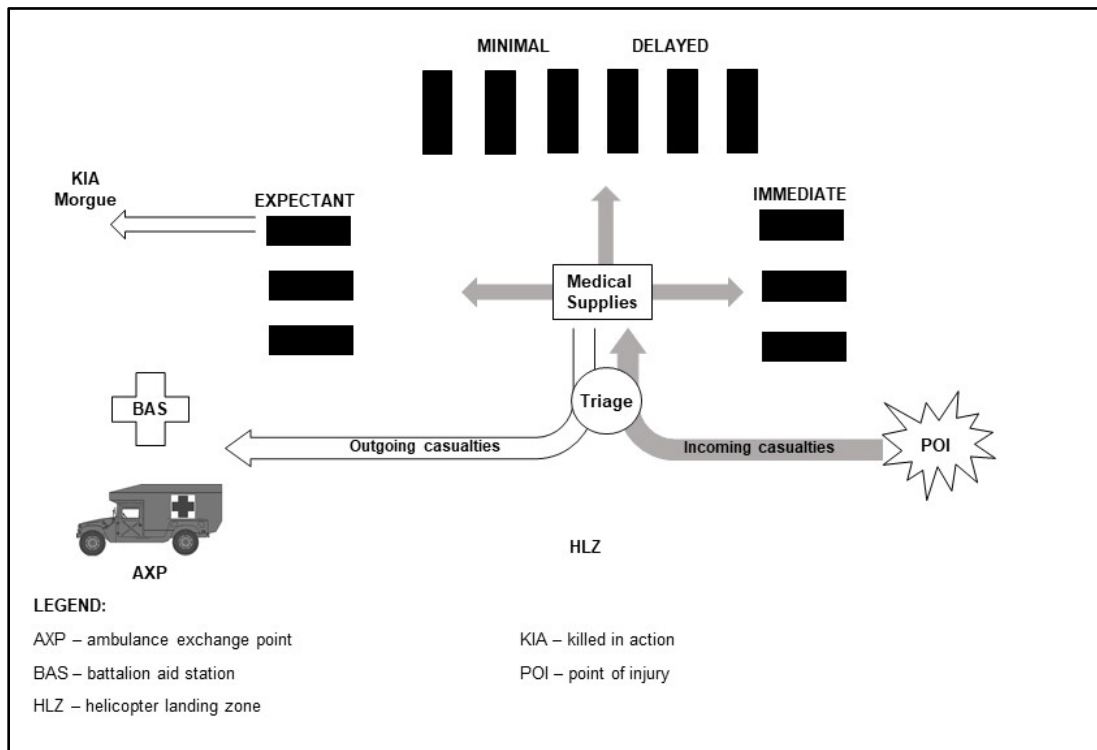

**Figure 1-2. Company casualty collection point**

1-48. Figure 1-3 on page 1-10 depicts how a CCP can be organized inside a building in an urban environment. The CCPs in subterranean environments may be organized in a similar method; but space may be more limited and unique environmental hazards such as poor air conditions, may require adjustments to mitigate risk such as increased monitoring of casualties and Soldiers.

1-49. Both CCP examples have a triage point where casualties are assigned a category and moved to an appropriate location. Triage categories are discussed in detail in ATP 4-02.3. The triage categories include the following:

- Immediate. This category is for a patient whose condition demands immediate resuscitative treatment. Approximately 20 percent of casualties are normally in this category.
- Delayed. This category is for patients who can tolerate a delay prior to time-consuming operative treatment without compromising the likelihood of a successful outcome. Approximately 20 percent of casualties are in this category.
- Minimal. This category is for patients with relatively minor injuries and most of those in this category are ambulatory. Most casualties are in this category.
- Expectant. This category includes patients where wounds are so extreme that even if they were the only patient and had all medical resources available, their survival would be unlikely. Expectant category patients should be separated from the others and kept as comfortable as possible but not abandoned. About 20 percent of casualties will be in this category.

1-50. Casualties coming from platoon CCPs may have been triaged but casualties should be re-evaluated to determine if their condition changed during evacuation. Medical supplies are located where they are easily accessed for use and resupply.

1-51. The CCPs may also include a collection point for sensitive items if the items have not been collected before evacuation. Some items will remain with the platoon but others may accompany the casualty to the company CCP, such as a personal weapon depending on the severity of wounds. Casualties who are triaged as minimal and delayed should be prepared to assist in defending the CCP as long as their injuries do not prevent them from safely operating their personal weapon.

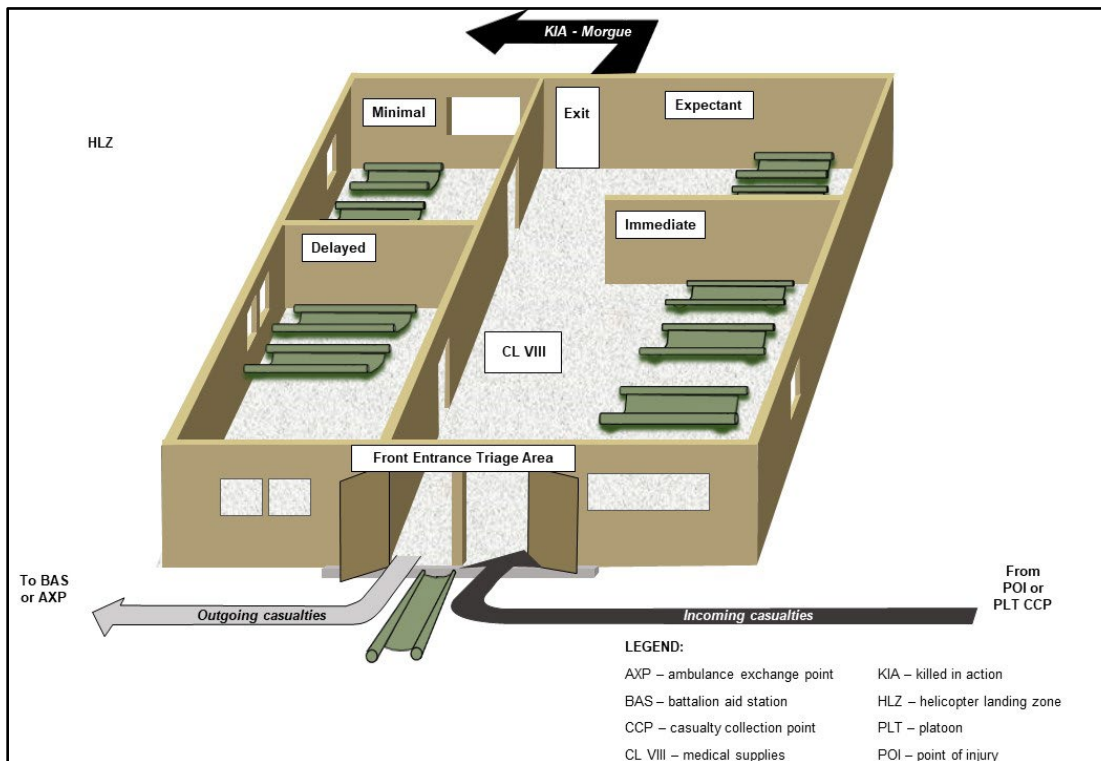

**Figure 1-3. Company casualty collection point in urban terrain**

1-52. In both CCP examples, expectant category casualties are placed in a separate area and away from the other casualties. This is done for morale purposes of the other casualties and enables the movement of remains to be conducted away from other casualties. The movement of human remains is a logistic function organized by the company executive officer and battalion S-4. Casualties being evacuated should not be moved on the same vehicle with human remains.

1-53. The standardization of triage category markings reduces confusion among litter teams. Methods of marking areas include marked tent stakes, laminated boards, and weighted coffee cans. Regular or infrared chemical lights may be used during periods of darkness. In some cases, the tactical situation will not permit a chemical light to be used without some concealment, such as placing the light into a can or box with small holes to reduce and direct the light. The light color or number of holes can be used to distinguish patient categories.

1-54. The resupply of medical supplies to the CCP should be included into training to identify problems and provide an opportunity for Soldiers to train on resupply procedures. Leaders should also consider the disposal of medical waste whenever the tactical situation permits, especially in environments with high probability of infectious disease.

## Chapter 2

# Manual Evacuation Methods

Manual evacuation is the process of transporting casualties by manual carries. It is accomplished without the aid of a litter or other forms of transport. It is intended to end at the point where a more sophisticated means of evacuation becomes available. For example, manual evacuation ends when a litter, vehicle, or other form of conveyance is available. Refer to TC 4-02.1 for additional information on handling and moving casualties.

### CASUALTY HANDLING

2-1. Casualties evacuated by manual means must be carefully handled. Rough or improper handling may cause further injury to the casualty. The movement effort should be organized and performed methodically. Each movement made in lifting or moving a casualty should be performed as deliberately and as gently as possible. Taking the tactical situation into consideration, casualties should not be moved before the type and extent of their injuries are evaluated and the required first aid (self-aid, buddy aid, or enhanced first aid) or tactical combat casualty care (combat medic or ambulance crew) is administered.

#### CAUTION

The exception to moving a casualty before evaluating type and extent of injury occurs when the situation dictates immediate movement for safety reasons. For example, if a casualty is inside, on or near a burning vehicle, or exposed to enemy fire, it may be necessary to first move the casualty to a safe location away from the hazard. This situation dictates that the urgency of casualty movement outweighs the need to administer first aid or tactical combat casualty care.

2-2. Every effort should be made to adequately treat or dress injuries to prevent loss of life, limb, or eyesight prior to moving the casualty. Except in extreme emergencies, the type and extent of injuries must be evaluated before any movement of the casualty is attempted. Measures are taken, as needed, to—

- Stop life-threatening bleeding.
- Open the airway and restore breathing and heartbeat.
- Prevent or control shock.
- Protect the wound from further contamination.

2-3. When a fracture is evident or suspected, the injured part must be immobilized. Every precaution must be taken to prevent the broken ends of the bone from cutting through muscle, blood vessels, nerves, and skin.

2-4. When a casualty has a serious wound, the dressing over the wound should be reinforced to provide additional protection during manual evacuation.

### GENERAL RULES FOR BEARERS

2-5. In manual evacuation, individuals performing the evacuation are referred to as bearers. Improper handling of a casualty can result in an injury to the bearers, as well as to the casualty. To minimize disabling

injuries (muscle strains, sprains, or other injuries) that could hamper the evacuation effort, the following rules should be followed:

- Use the body's natural system of levers when lifting and moving a casualty.
- Know your physical capabilities and limitations.
- Maintain solid footing when lifting and transporting a casualty.
- Use the leg muscles (not the back muscles) when lifting or lowering a casualty.
- Use the shoulder and leg muscles (not the back muscles) when carrying or standing with a casualty.
- Keep the back straight; use arms and shoulders when pulling a casualty.
- Work in unison with other bearers, using deliberate, gradual movements.
- Slide or roll, rather than lift, heavy objects that must be moved.
- Rest frequently, or whenever possible, while transporting a casualty.
- Carry your weapon so that it does not harm the casualty but can be put into operation quickly.

2-6. Normally, a casualty's individual weapon is not moved with them through the evacuation chain. Prior to moving the casualty from the POI, the bearer should make every effort to secure the injured Soldier's weapon and sensitive items (if any). Every attempt should be made for the Soldier's unit to secure the weapon and sensitive items prior to evacuation. In those circumstances where this is not possible, weapons and sensitive items will travel to the first MTF where they will be secured and held until the Soldier's parent unit can claim them. Individual equipment, to include protective clothing and mask, remains with the casualty, and is evacuated with them.

### CASUALTY POSITIONING

2-7. The first step in any manual carry is to position the casualty to be lifted. If the casualty is conscious, they should be told how they are to be positioned and transported. This helps to lessen their fear of movement and to gain their cooperation. Personnel should attempt to stabilize the neck and spine as much as possible to prevent further injury. It may be necessary to roll the casualty onto their abdomen, or back, depending upon the position in which they are lying and the particular carry to be used. This can be accomplished by performing the following:

- Roll a casualty onto their abdomen, kneel at the casualty's uninjured side, and perform the following:
  - Place their arms above their head; cross their ankle which is farthest from you over the one that is closer to you.
  - Place one of your hands on their shoulder which is farthest from you; place your other hand in the area of the hip or thigh.
  - Roll them gently toward you onto their abdomen (figure 2-1).
- Roll a casualty onto their back, follow the same procedure as described above, except gently roll the casualty onto their back, rather than onto their abdomen.



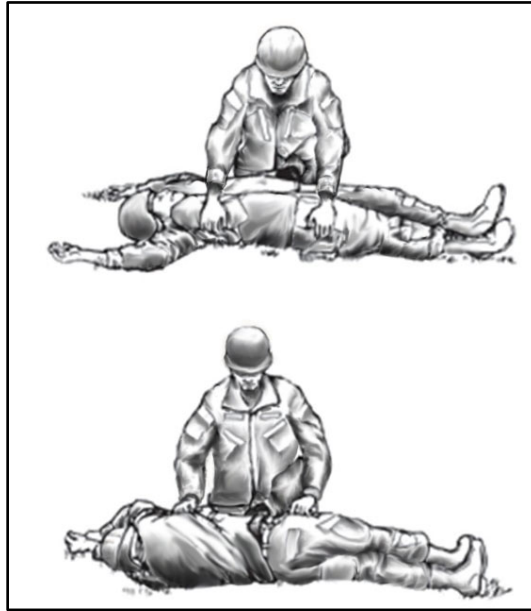

**Figure 2-1. Positioning the casualty on their abdomen**

---

*Note.* Casualties with abdominal injuries should not be rolled onto their abdomen and should be carried with an alternate method.

---

## MANUAL CARRIES

2-8. Manual carries are tiring for the bearers and involve the risk of increasing the severity of the casualty's injuries. In some instances, however, they are essential to save the casualty's life. When a litter is not available or when the terrain or the tactical situation makes other forms of casualty transport impractical, a manual carry may be the only means to transport a casualty to where a combat medic can treat them. The distance a casualty can be transported by a manual carry depends upon—

- Strength and endurance of the bearers.
- Weight of the casualty.
- Nature of the injuries.
- Obstacles encountered during transport.

2-9. Carries can be used to move both a conscious and an unconscious casualty by one or two bearers. Carries, when performed correctly (paragraphs 2-10 through 2-21), provide the casualty more protection from further injury than drags (paragraphs 2-23 through 2-26) and are used to move a casualty a greater distance (from 50 to 300 meters depending on the carry).

### ONE-MAN CARRIES

2-10. One-man carries are generally used for moving a casualty over a short distance and may quickly tire the bearer. The bearer may have to plan locations with cover and concealment to rest before continuing.

#### Fireman's Carry

2-11. The fireman's carry (figure 2-2 on page 2-4) is one of the easiest ways for one individual to carry another. After an unconscious or disabled casualty has been properly positioned, they are raised from the ground, then supported and placed in the carrying position. When possible, the bearer should transport the

casualty so that the bearer's dominant (firing) hand is free. This can be accomplished by performing the following:

- After rolling the casualty onto their abdomen, straddle them. Extend your hands under their chest and lock them together.
- Lift the casualty to their knees as you move backward.
- Continue to move backward, thus straightening the casualty's legs and locking their knees.
- Walk forward, bringing the casualty to a standing position; tilt them slightly backward to prevent their knees from buckling.
- As you maintain constant support of the casualty with one arm, free your other arm and quickly grasp their wrist, and raise their arm high. Instantly pass your head under their raised arm, releasing it as you pass under it.
- Move swiftly to face the casualty and secure your arms around their waist. Immediately place your foot between their feet and spread them apart (approximately 6 to 8 inches).
- Grasp the casualty's wrist and raise their arm high over your head.
- Bend down and pull the casualty's arm over and down on your shoulder, bringing their body across your shoulders. At the same time, pass your arm between their legs.
- Grasp the casualty's wrist with one hand and place your other hand on your knee for support.
- Rise with the casualty positioned correctly. Your free hand may be used to grasp your weapon.



Figure 2-2. Fireman's carry

2-12. The alternate method of the fireman's carry for raising a casualty from the ground is illustrated in figure 2-3; however, it should be used only when the bearer believes it to be safer for the casualty because of the location of the wounds. When the alternate method is used, care must be taken to prevent the casualty's head from snapping back and causing a neck injury. The steps for raising a casualty from the ground for the fireman's carry are also used in other one-man carries.

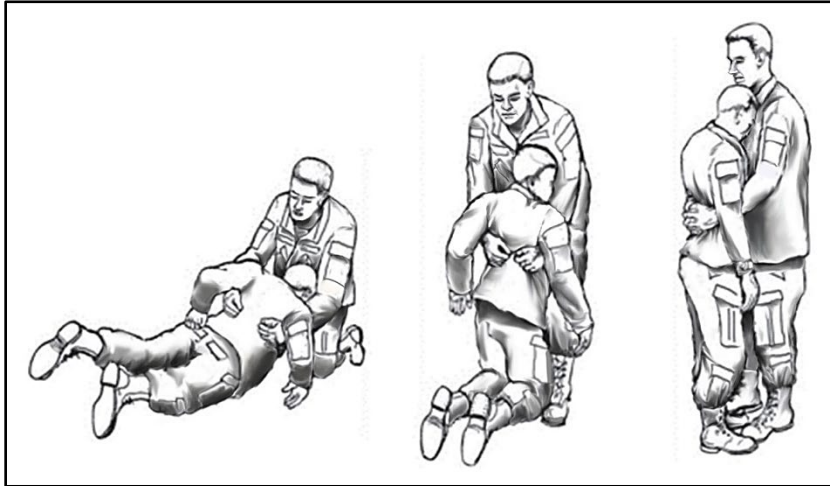

**Figure 2-3. Fireman's carry (alternate method for lifting the patient to a standing position)**

### Supporting Carry

2-13. In the supporting carry (figure 2-4), the casualty must be able to walk, or at least hop, on one leg, using the bearer as a crutch. This carry can be used to transport a casualty as far as they are able to walk or hop. To use this technique—

- Raise the casualty from the ground to a standing position by using the process described above for getting them positioned for the fireman's carry.
- Grasp the casualty's wrist and draw their arm around your neck.
- Place your arm around their wrist. The casualty is now able to walk or hop, using you as a support.



**Figure 2-4. Supporting carry**

## Arms Carry

2-14. The arms carry (figure 2-5) is useful in carrying a casualty for a short distance (up to 50 meters) and for placing a casualty on a litter. This carry requires greater upper body strength than other carries and can cause the carrier to quickly become fatigued. To use this technique—

- Raise or lift the casualty from the ground to a standing position, as in the preparation for the fireman's carry.
- Place one arm under the casualty's knees and your other arm around their back.
- Lift the casualty.
- Carry the casualty high to lessen fatigue.



**Figure 2-5. Arms carry**

## Saddleback Carry

2-15. Only a conscious casualty can be transported by the saddleback carry (figure 2-6 on page 2-7) because they must be able to hold onto the bearer's neck. To use this technique—

- Raise the casualty to an upright position, as in the preparation for the fireman's carry.
- Support the casualty by placing an arm around their waist. Move to the casualty's side. Have the casualty put their arm around your neck and move in front of them with your back to them.
- Have the casualty encircle their arms around your neck.
- Stoop, raise them on your back, and clasp your hands together beneath their thighs, if possible.
- Carry the casualty high to lessen fatigue.



**Figure 2-6. Saddleback carry**

### **Pack-Strap Carry**

2-16. In the pack-strap carry (figure 2-7 on page 2-8) the casualty's weight rests high on your back. This makes it easier for you to carry the casualty a moderate distance (50 to 300 meters). To eliminate the possibility of injury to the casualty's arms, you must hold the casualty's arms in a palms-down position. To use this technique—

- Lift the casualty from the ground to a standing position, as in the preparation for the fireman's carry.
- Support the casualty with your arms around them and grasp one of their wrists and pull it closer to you.
- Place their arm over your head and across your shoulders.
- Move in front of the casualty; while still supporting their weight against your back.
  - Grasp their other wrist and place this arm over your shoulder.
  - Bend forward and raise or hoist the casualty as high on your back as possible so that their weight is resting on your back.

---

*Note.* Once the casualty is positioned on the bearer's back, the bearer remains as erect as possible to prevent straining or injuring to their back.

---



Figure 2-7. Pack-strap carry

## TWO-MAN CARRIES

2-17. Two-man carries should be used whenever possible. Two-man carries provide more comfort for the casualty, are less likely to aggravate injuries, and are less tiring for the bearers. Five different two-man carries can be used.

### Two-Man Supporting Carry

2-18. The two-man supporting carry (figure 2-8) can be used in transporting both conscious and unconscious casualties. If the casualty is taller than the bearers, it may be necessary for the bearers to lift the casualty's legs and let them rest on their forearms. The bearers—

- Help the casualty to their feet and support them with their arms around their waist.
- Grasp the casualty's wrists and draw their arms around their necks.

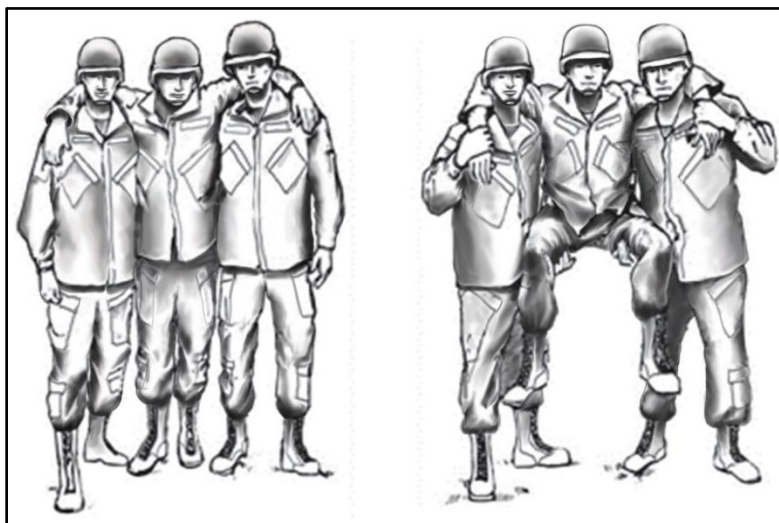

Figure 2-8. Two-man supporting carry

### Two-Man Arms Carry

2-19. The two-man arms carry (figure 2-9) is useful in carrying a casualty for a moderate distance (50 to 300 meters) and placing them on a litter. To lessen fatigue, the bearers should carry the casualty high and as close to their chests as possible. In extreme emergencies when there is not time to obtain a spine board, this carry

is the safest one for transporting a casualty with a back injury. If possible, two additional bearers should be used to keep the casualty's head and legs in alignment with their body. The bearers—

- Kneel at one side of the casualty and place their arms beneath the casualty's back, waist, hips, and knees.
- Lift the casualty while rising to their knees.
- Turn the casualty toward their chests, while rising to a standing position.
- Carry the casualty high to lessen fatigue.

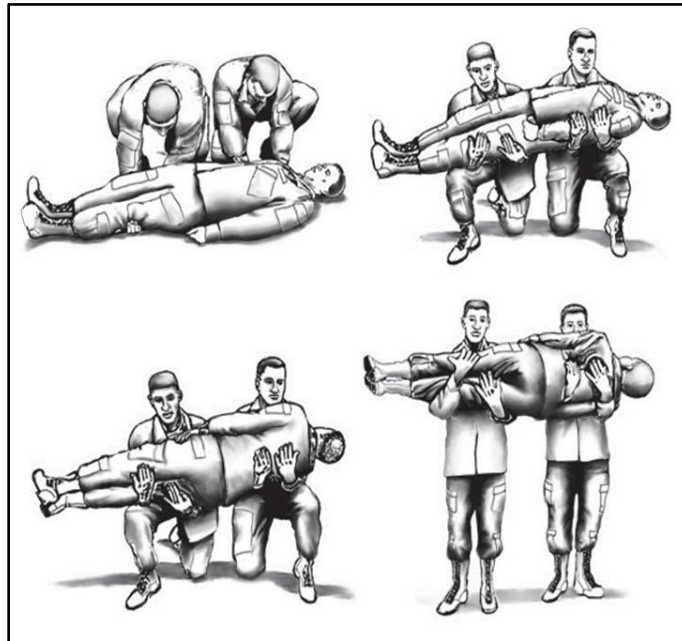
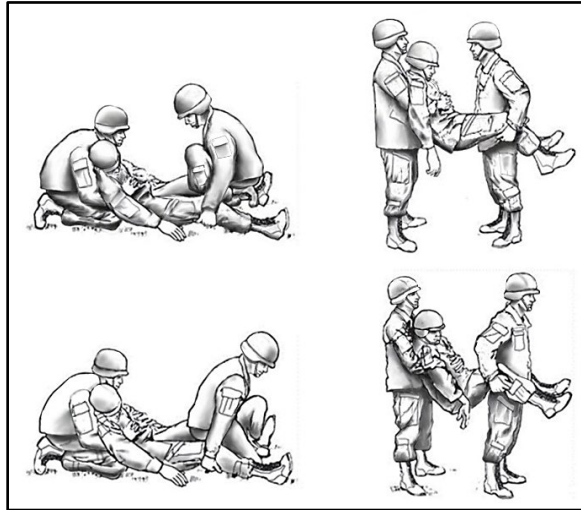

**Figure 2-9. Two-man arms carry**

### **Two-Man Fore-and-Aft Carry**

2-20. The two-man fore-and-aft carry (figure 2-10 on page 2-10) is a useful two-man carry for transporting the casualty over a long distance (over 300 meters). The taller of the two bearers should position themselves at the casualty's head. By altering this carry so that both bearers face the casualty, it is useful for placing a casualty on a litter. To use this technique—

- One bearer spreads the casualty's legs and kneels between them with their back to the casualty. They position their hands behind the casualty's knees. The other bearer kneels at the casualty's head, slides their hands under the arms, across their chest, and locks their hands together.
- The two bearers rise together, lifting the casualty.

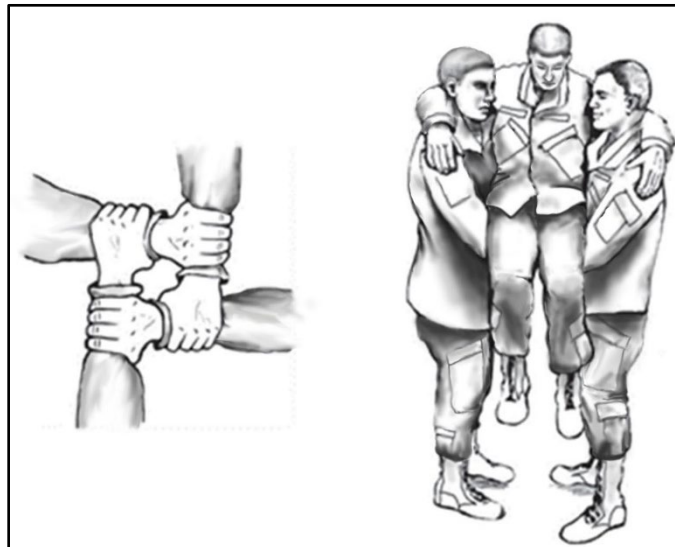

**Figure 2-10. Two-man fore-and-aft carry**

### Four-Hand Seat Carry

2-21. Only a conscious casualty can be transported with the four-hand seat carry (figure 2-11) since the casualty must help support the bearers by placing their arms around the bearers' shoulders. This carry is especially useful in transporting a casualty with a head or foot injury for a moderate distance (50 to 300 meters). It is also useful in placing a casualty on a litter. To use this technique—

- Each bearer grasps one of their own wrists and one of the other bearer's wrists, thus forming a packsaddle.
- The two bearers lower themselves sufficiently for the casualty to sit on the packsaddle; then, they have the casualty place their arms around the bearers' shoulders for support. The bearers then rise to an upright position.



**Figure 2-11. Four-hand seat carry**



## Two-Hand Seat Carry

2-22. The two-hand seat carry (figure 2-12) is used when carrying a casualty for a short distance (up to 50 meters) and in placing a casualty on a litter. With the casualty lying on their back, a bearer kneels on each side of the casualty at their hips. Each bearer passes their arms under the casualty's thighs and back and grasps the other bearer's wrists. The bearers rise lifting the casualty.



Figure 2-12. Two-hand seat carry

## DRAGS

2-23. Drags are used to move a casualty when the situation dictates that an expedient removal from dangerous situations or hostile environments is required. Drags allow the bearer and the casualty to stay low and use cover and concealment to move out of hazardous areas when the use of upright manual carries or litters would put the bearers and casualty in greater danger. Drags are generally used for short distances of up to 50 meters.

### CAUTION

Rough or improper handling may cause further injury to the casualty.

## PERSONNEL DRAG

2-24. A conscious or unconscious casualty can be readily grasped by the individual's equipment (clothing, equipment harness, or body armor drag strap). This casualty can then be dragged to an area of safety where they can be treated and further evacuated by other means. This drag can be accomplished by one or two bearers and provides one of the fastest means to move a casualty. As with most drags it provides a minimum amount of protection for the casualty's injuries and is only used to move the casualty out of imminent danger. The bearer or bearers grasp the casualty by their equipment and pull them backwards to safety. Another variation for moving a conscious casualty is to have the casualty assist by grasping the bearer's hands or forearms over their shoulders. The bearer also grasps the casualty by their hands or forearms and pulls the casualty backwards to safety (figure 2-13 on page 2-12).

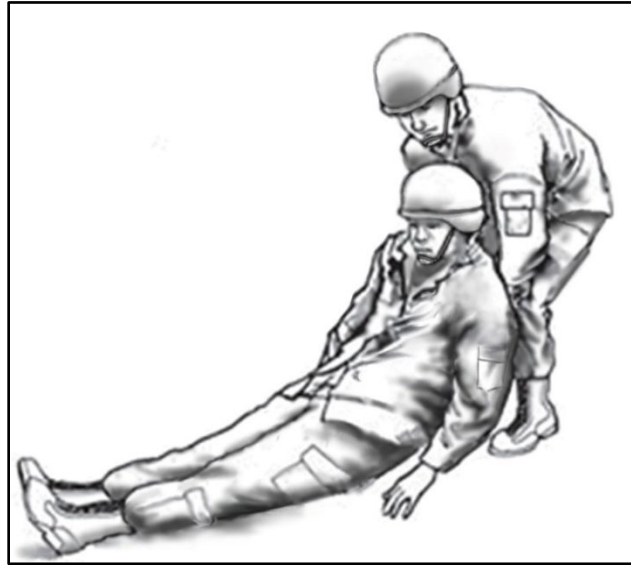

**Figure 2-13. Personnel drag**

## NECK DRAG

2-25. The neck drag (figure 2-14) is useful in combat because the bearer can transport the casualty as they creep behind concealment or under obstacles. The neck drag cannot be used if the casualty has a broken arm. To use this technique, perform the following:

---

*Note.* If the casualty is conscious, they may clasp their hands together around the bearer's neck.

---

- Tie the casualty's hands together at the wrists.
  - Straddle the casualty in a kneeling face-to-face position.
  - Loop the casualty's tied hands over and around your neck.
  - Crawl forward dragging the casualty with you.
- 

*Note.* If the casualty is unconscious, their head must be protected from the ground.

---

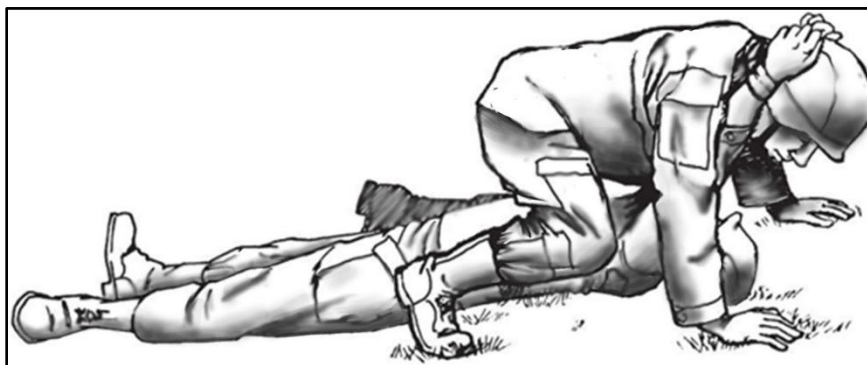

**Figure 2-14. Neck drag**

## CRADLE-DROP DRAG

2-26. The cradle-drop drag (figure 2-15) is effective in moving a casualty up or down stairs, steps, or to maintain a low profile. To use this technique, perform the following:

- Kneel at the casualty's head (with the casualty lying on their back). Slide your hands, with palms up, under the casualty's shoulders, and get a firm hold under their armpits.
- Rise (partially), supporting the casualty's head on one of your forearms. You may bring your elbows together and let the casualty's head rest on both of your forearms.
- Rise and drag the casualty backward. (The casualty is in a semisitting position.)
- Back down the steps, supporting the casualty's head and body, and letting their hips and legs drop from step to step.

---

*Note.* If the casualty needs to be moved up steps, bearer should back up the steps, using the same procedure.

---

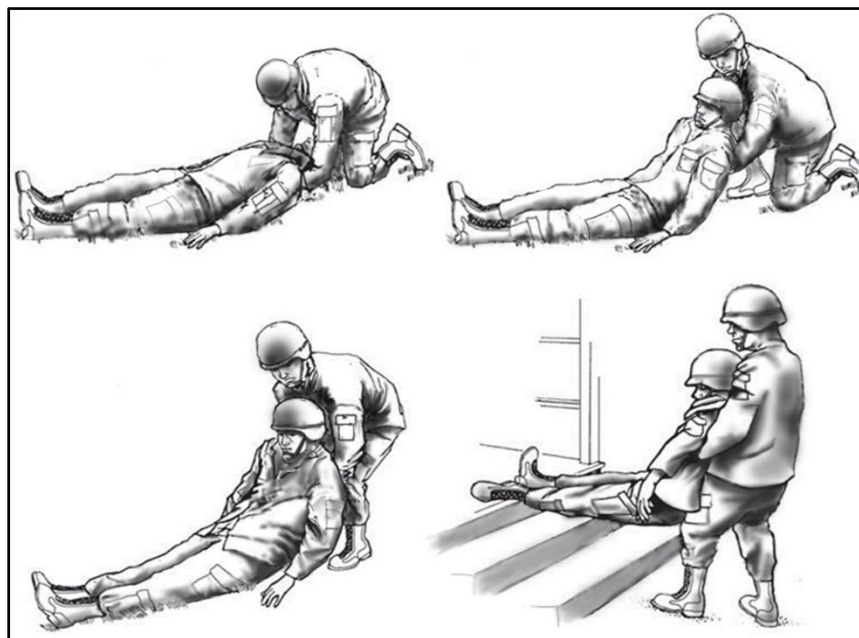

Figure 2-15. Cradle-drop drag

This page intentionally left blank.

## Chapter 3

# Litter Evacuation

When possible, a casualty should be transported on a litter rather than using a manual carry. A litter is more comfortable for the casualty and less likely to aggravate their injuries. The use of a litter makes evacuation easier and quicker. It also allows the casualty to be carried much farther than with manual carries. A standard litter should be used when available. If no standard litter is available, an improvised litter can be used as a suitable replacement until the casualty can be transferred to a standard litter. Standard litters should always be in a serviceable condition. Some of the standard and improvised litters used in the field are discussed below.

---

**This paragraph implements STANAG 2040.**

---

## STANDARD LITTERS

3-1. The standardization of a litter's dimensions allows a patient to travel in various medical vehicles on the same litter; thereby, minimizing the possibility of further injury and saving valuable time. The Army uses several types of standard litters.

3-2. Army watercraft use a combination of rigid full body boards and rescue basket litters to extract personnel from engine and living spaces and conduct over-water evacuation to another vessel or aircraft for evacuation. See Technical Manual (TM) 4-15.21 for additional information including correct application of straps and sling assembly for over-water hoisting.

## STANDARD COLLAPSIBLE LITTER

3-3. The standard collapsible litter (figure 3-1 on page 3-2) is no longer used in updated medical equipment sets but still may be used by some units, especially to equip a unit CASEVAC kit. It only folds along the long axis.

- The basic components of the litter are:
  - Two straight, rigid, lightweight aluminum poles.
  - A cover (bed) of cotton duck or other durable fabric.
  - Four wooden or plastic material handles attached to the poles.
  - Four stirrups (one bolted near the end of each pole). The stirrups support the litter when it is placed on the ground.
  - Two spreader bars (one near each end of the litter). These bars are extended crosswise at the stirrups to hold the cover taut when the litter is open.
  - Two litter securing straps (one attached to each pole at the stirrup bolts). These straps are used to secure the litter when it is closed.
- Dimensions of the standard collapsible litter is as follows:
  - Overall length is 90 inches.
  - Overall width is 22 7/8 inches.
  - Bed length is 72 inches.
  - Bed width is 22 7/8 inches.
  - Weight is 15 pounds.

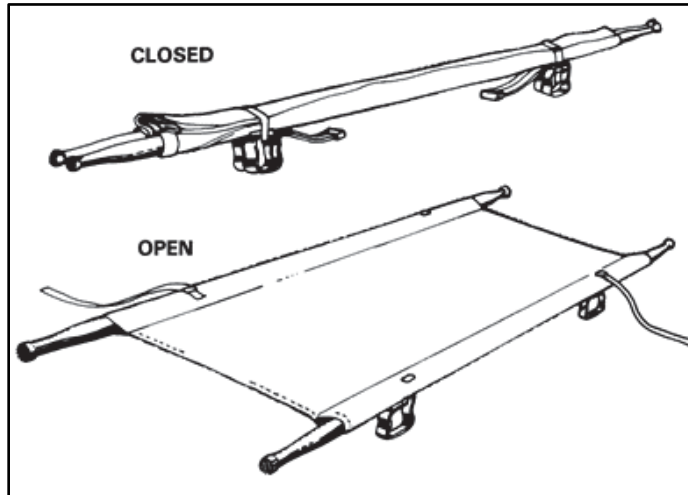

**Figure 3-1. Standard collapsible litter**

### **RIGID POLE FOLDING LITTER**

3-4. The rigid pole folding litter (figure 3-2) has replaced the legacy standard collapsible litter. The rigid pole folding litter National Stock Number (NSN) 6530-00-783-7905 is 90 inches long with nominal adjustable handles (from 90 inches to 94 3/8 inches) (figure 3-2) and (figure 3-3 on page 3-3). It has a spreader bar and stirrup assemblies with interlocking securing buckles. It also has aluminum poles, nylon handles, and a plastic polypropylene cover. This litter can be decontaminated and is painted with a chemical agent-resistant material. It is assembled in the folded position and weighs 25 pounds.



**Figure 3-2. Rigid pole folding litter**



**Figure 3-3. Adjustable handle rigid pole folding litter**

### DECONTAMINATION MASS CASUALTY, LITTER

3-5. The decontamination mass casualty, litter (NSN 6530-01-432-5114) consists of aluminum poles painted with chemical agent resistant-coating (figure 3-4). It conforms to all North Atlantic Treaty Organization (NATO) standards and weighs about 15 pounds. The cover fabric is a honeycomb weave of monofilament polypropylene. The fabric will not absorb agents and is not degraded by decontamination fluids. It is flame retardant and rip resistant. It is also treated to withstand weather and sunlight.



**Figure 3-4. Decontamination mass casualty litter**

### FOLDING RIGID LITTER

3-6. The folding rigid litter (NSN 6530-01-380-7309) is often used in tactical operations where its smaller size allows it to be carried inside of military vehicles, by dismounted Soldiers, and during airborne operations (figure 3-5 on page 3-4). The folding aluminum litter when opened is very similar to the standard collapsible litter. The folding litter poles are hinged in the middle, which allows the litter to be folded lengthwise. To reduce the overall folded size, the stirrups also fold flat against the poles. The folding aluminum litter usually comes with two or four patient securing straps. There are two basic variants of folding litters, one version folds in half (bifold) and the other version has multiple hinges that allows it to be even more compact. The dimensions of the folding litter are:

- The length of a litter is adjustable from 90 inches to 94.4 inches with adjustable handles extended when open, but is about 45 1/2 inches when the litter is folded lengthwise depending on the model.

- When open, the litter bed measures 72 inches in length and slightly more than 22 inches across.
- The litter weight is about 15 to 25 pounds depending on the model.



**Figure 3-5. Folding rigid litter**

### **MULTIHINGED FOLDING LITTER**

3-7. Another type of folding litter, with the same general dimensions as the standard litter when open, is the multihinged folding litter. This includes the portable lightweight compact litter (NSN 6530-01-452-1651) with collapsible handles. It has folding lightweight poles with two hinges that further reduces its overall size when folded (figure 3-6). The litter can be folded to a compact size of 20 1/4 x 8 x 7 inches when not in use. In its extended configuration the litter is 90 inches long (78 inches long with the handles collapsed).

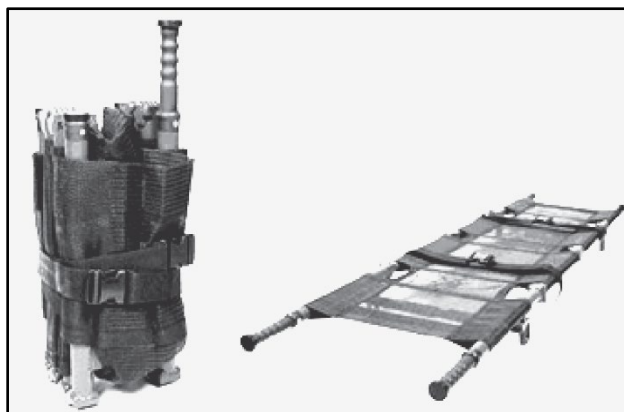
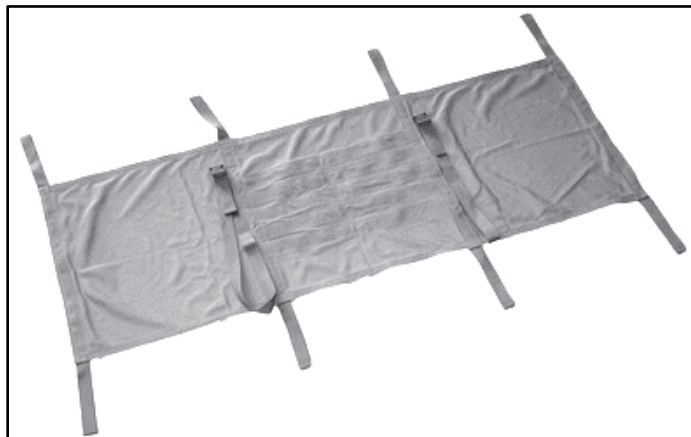

**Figure 3-6. Portable lightweight compact litter**

### **POLELESS NONRIGID LITTER**

3-8. The poleless nonrigid litter (figure 3-7) can be folded or rolled and carried by the Soldier, combat lifesaver, or combat medic. It has folds into which improvised poles can be inserted for evacuation over long distances. It also has slings for hoisting, lowering, and carrying, and allows the use of patient securing straps to secure the casualty to the litter.





**Figure 3-7. Poleless nonrigid litter**

### **RESCUE AND TRANSPORT SYSTEM/NONRIGID LITTER**

3-9. The rescue and transport system/nonrigid litter (figure 3-8) (NSN 6530-01-575-4004) is a commercial off-the-shelf evacuation litter system that functions in a traditional land-based application. It is a compact, lightweight, and versatile litter system used to evacuate a casualty from confined spaces, over rough terrain, water rescues with attached floatation devices, and is the primary litter used by the Army in helicopter hoist missions. When the casualty is packaged the stretcher becomes rigid. The durable plastic provides protection for the patient or casualty while allowing extrication from austere areas. The nonrigid litters are nearly identical with small variations such as color (NSN 6530-01-678-6791).



**Figure 3-8. Rescue and transport system/nonrigid litter**

## SPINE BOARD

3-10. Spine boards aid in moving and immobilizing casualties with known or suspected spinal injuries. Spine boards are normally prefabricated from plywood or any suitable material (figure 3-9).

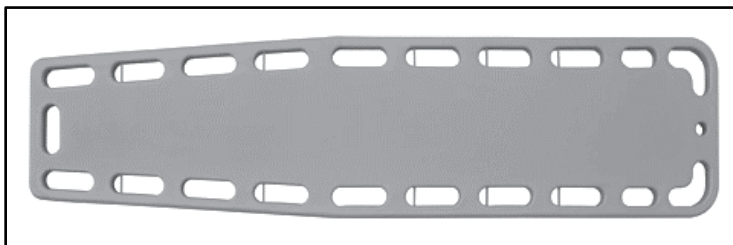

**Figure 3-9. Spine board**

3-11. The spine board is used when a casualty has a fracture or suspected fracture of the back or neck. To apply the spine board, the bearers assemble the required items: a spine board, four 6-foot patient securing straps, a cravat, and four pieces of padding. If an item is not available, the bearers should improvise it from any available material such as a door or piece of plywood. If the tactical situation permits, consider the use of a spine board for evacuation of any patient that has sustained injuries secondary to a blast, or any injury in which a significant traumatic brain injury may be suspected. To place and secure a casualty to a spine board perform the following:

- The bearers place the spine board beside the casualty. They align it with the casualty's body. They then place padding on the board at the points where the casualty's neck, small of the back, knees, and ankles will rest.
- All commands come from bearer number 1 who kneels at the right side of the casualty's head (see Appendix B on page B-1 for litter team training). Bearer 1 places their hands on each side of the casualty's head and jaws, immobilizing the head and neck and applying slight traction (figure 3-10). Bearers number 2, 3, and 4 kneel on one side of the patient and place their hands on the opposite side at the patient's shoulder and waist, hip and thigh, knee and ankle (figure 3-11).



**Figure 3-10. Positioning of hands**

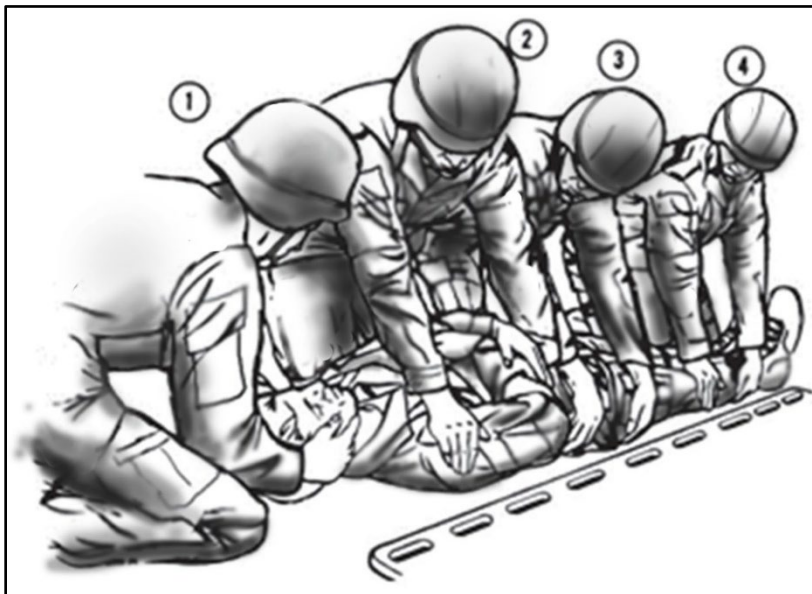
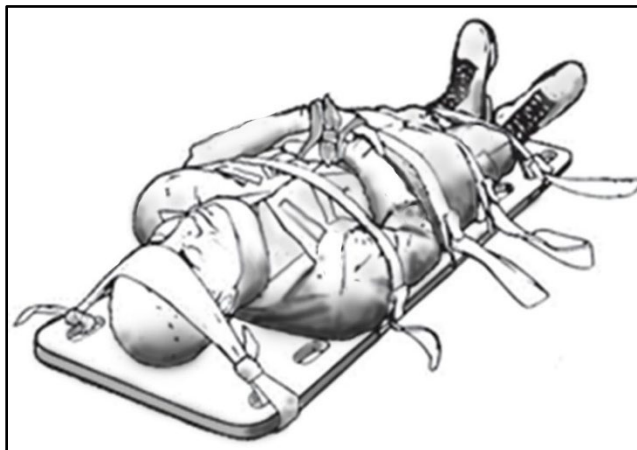

**Figure 3-11. Positioning of litter bearers**

- Bearers number 2, 3, and 4 roll the casualty's body slightly toward them as bearer number 1 turns the casualty's head, keeping it in a straight line with the spine.
- Bearer number 3 reaches across the casualty's body with one hand, grasps the board at the nearer edge and slides it against the casualty. Bearer number 3, with the same hand, reaches across the board to the farther edge and holds the board in place. All of the bearers then slowly roll the casualty backward onto the board, keeping the head and spine in a straight line.

While bearer number 1 continues to apply slight traction to the neck, bearers number 2, 3, and 4 immobilize the casualty by applying the cravat and four patient securing straps (figure 3-12 on page 3-8) in the following order:

- The center of the cravat is placed over the casualty's forehead with the middle of the cravat covering the hairline. The ends are then extended straight across and inserted through the nearest holes on each side of the board.
- One end of the first patient securing strap is inserted through the board hole near the chest, across the chest, and through the hole on the opposite side. It is then brought back across the arms and buckled to the other end of the strap. The buckle rests on the top of the board, not against the casualty.
- The three remaining straps are applied: one across the hips, one above the knees (not over the kneecaps), and one above the ankles. One end of each strap is inserted through the board hole near the body part and buckled to the other end of the strap. The buckle rests on the top of the board, not against the casualty.



**Figure 3-12. Positioning of litter straps**

### **PATIENT SECURING STRAP**

3-12. The patient securing strap (figure 3-13) NSN 6530-00-784-4205, is used to hold the casualty in position on the litter. It is designed to fit the straight and folding aluminum litters, as well as other standard litters. It is available in quantities of four per litter. This strap can also be used with an improvised litter and as a patient restraint, if required. It is made from a 6-foot length of 2-inch webbing and a buckle with a locking device and spring. Additional restraining devices may be used depending on the litter and circumstances. Other applications include the use of a multipoint restraint harness that provides up to ten attachment points. These straps secure the casualty's shoulder and foot areas to the litter and provide better immobilization over rough terrain and while loading and unloading the litter onto high profile vehicles. A minimum of two straps should be used when transporting a patient on a litter.



**Figure 3-13. Patient securing strap**

### **IMPROVISED LITTERS**

3-13. There are times when a casualty may have to be moved and a standard litter is not available. The distance may be too great for manual carries or the casualty may have an injury (such as a fractured neck, back, hip, or thigh) that would be aggravated by manual transportation. In these situations, litters can be improvised from materials at hand. Improvised litters must be as well constructed as possible to avoid the risk of dropping or further injuring the casualty. Improvised litters are emergency measures and must be replaced by standard litters at the first opportunity.

3-14. Many different types of litters can be improvised, depending upon the materials available. A satisfactory litter can be made by securing poles inside such items as a blanket (figure 3-14), poncho, shelter half, tarpaulin, mattress cover, jackets, shirts (figure 3-15), or bags and sacks (figure 3-16 on page 3-10). Poles can be improvised from strong branches, tent poles, skis, lengths of pipe, and other objects. If objects for improvising poles are not available, a blanket, poncho, or similar item can be rolled from both sides

toward the center so the rolls can be gripped for carrying a casualty (Figure 3-17 on page 3-10). Most flat-surface objects of suitable size can be used as a litter. Such objects include doors, boards, window shutters, benches, ladders, cots, and chairs. If possible, these objects should be padded for the casualty's comfort.

### IMPROVISED LITTER USING BLANKETS AND POLES

3-15. To improvise a litter using blankets and poles, the following steps should be used:

- Open the blanket and lay one pole lengthwise across the center; then fold the blanket over the pole.
- Place the second pole across the center of the folded blanket.
- Fold the free edges of the blanket over the second pole and across to the first pole



Figure 3-14. Litter made with blankets and poles

### IMPROVISED LITTER FROM SHIRTS OR JACKETS AND POLES

3-16. To improvise a litter using shirts or jackets, button or zip the shirt or jacket and turn it inside out, leaving the sleeves inside, then pass the pole through the sleeves.

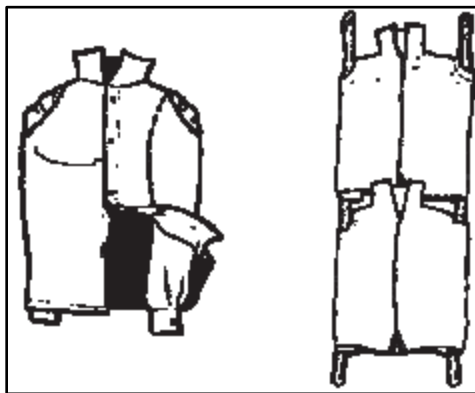
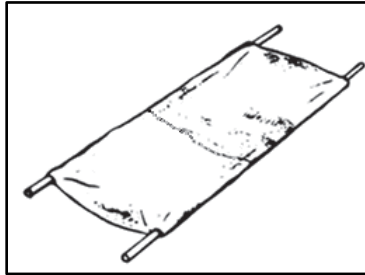

Figure 3-15. Litter improvised from jackets and poles

### IMPROVISED LITTER FROM BAGS, SACKS, AND POLES

3-17. To improvise a litter from bags, sacks, and poles, rip open the corners of the bags or sacks; then pass the poles through them. Overlap the bags or sacks to provide support for the middle of the bed to prevent the casualty from falling through.



**Figure 3-16. Litter improvised from sacks and poles**

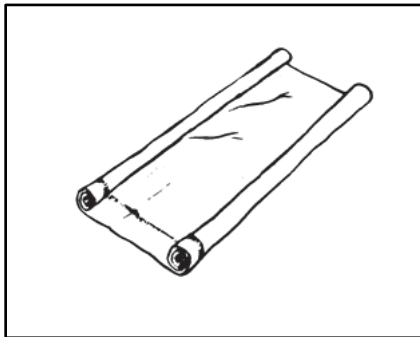

**Figure 3-17. Rolled blanket litter**

### **ROLLED BLANKET LITTER**

3-18. If no poles are available, roll a blanket, shelter half, tarpaulin, or similar item from both sides toward the center (figure 3-17). Grip the rolls to carry the casualty (figure 3-18).



**Figure 3-18. Rolled blanket used as a litter**

## TRAVOIS

3-19. This method of evacuation requires trained personnel and a good natured animal. Additional information on the use of pack animals can be found in ATP 3-18.13. A travois is a primitive vehicle for transporting loads. It can be lashed to a horse or similar animal and dragged along the ground. It can also be lashed between two animals in single file and carried level. The travois is made from two long poles fastened together by two crossbars and a litter bed fastened to the poles and crossbars. The casualty is secured on the litter bed. If the travois is pulled by only one animal, the bearers lift the dragging end from the ground when going uphill, fording streams, or crossing obstacles. To make a travois:

- Cut two poles about 16-feet long (one pole should be 8 to 10 inches longer than the other). Ensure that the small ends are at least 2 inches in diameter. Then cut two crossbars which are about 3-feet long.
- Lay the poles parallel to each other. They should be placed about 2 1/2 feet apart with the larger ends to the front. If only one animal is used, let the smaller ends spread apart about 3 feet and have one of the small ends project 8 to 10 inches beyond the other one. This results in a rocking motion, rather than a jolting motion to the patient.
- Notch the poles and the crossbars so that the poles can be connected with one crossbar about 6 feet from the front end and the other crossbar about 6 feet to the rear of the first one. Fit the notches in the crossbars and poles together and lace them securely in place.
- Make a litter bed 6 feet long between the crossbars. This is done by fastening a blanket, canvas, or similar material securely to the poles and crossbars.
- If only one animal is used, securely fasten the front ends of the poles to the saddle of the animal. Leave the other ends of the poles on the ground (figure 3-19).
- If two animals are used, securely fasten the front ends of the poles to the saddle of the lead animal and the other end of the poles to the saddle of the animal which follows. (Figure 3-20 on page 3-12).

---

*Note.* A rope or strap may be stretched diagonally from pole to pole, letting it cross many times to form a base for an improvised bed. A litter or cot may also be fastened between the poles for the same purpose.

---



**Figure 3-19. Travois litter**



**Figure 3-20. Suspended litter**



## Chapter 4

# Casualty Evacuation Platforms

During large-scale combat operations, ambulances may be unavailable, too few in number to meet evacuation demands, or incapable of evacuating patients over certain types of terrain. In these instances, many vehicles available to most units can be used to transport casualties with little or no change in their configuration. Units should plan and train on how their organic vehicles can be used to move casualties both on and off litters. While this chapter describes recommended loading solutions for some Army platforms, planners should consider their organic platforms as well as all platforms that may be available including civilian, other services, and coalition.

### SECTION I – GROUND VEHICLES USED FOR CASUALTY EVACUATION

4-1. Organizations need to assess the organic nonmedical vehicles available and determine how they can be used to evacuate casualties. Casualties can be designated as ambulatory or litter, and the casualties that need to be transported on a litter present the greatest challenge as planning and training are required to successfully meet the requirements of loading and moving them to CCPs, AXPs, or to MTFs.

4-2. When loading casualties onto vehicles or aircraft, the most critical casualties should be loaded last or positioned so that they can be unloaded first or be more accessible for en route care. For platforms not listed, organizations can use these examples to develop their own safe-loading configurations, and add them to their operational plans, and unit SOPs. Medical personnel must be included in this development to ensure tactics, techniques, and procedures do not cause further injury to the casualty.

### NONMEDICAL WHEELED VEHICLES

4-3. Ground vehicles provide capacities ranging from an individual litter to numerous ambulatory and litter patients better suited for mass-casualty situations. Wheeled vehicles are best suited for roadways and have limited cross country capability, depending on the difficulty of the terrain. Wheeled vehicles are generally quicker than tracked vehicles but offer less protection.

### M998 TRUCK, CARGO/TROOP CARRIER, 1 1/4-TON, HIGH-MOBILITY MULTIPURPOSE WHEELED VEHICLE (FOUR-PERSON CONFIGURATION)

4-4. The M998 high-mobility multipurpose wheeled vehicle (HMMWV), 1 1/4-ton cargo truck in the four-person configuration (figure 4-1 on page 4-2), can be easily adapted for transporting three litters. To convert this vehicle for carrying litters, follow the procedures listed below:

- Remove the cargo cover and metal bows. Secure them in place. Lower the tailgate.
- Place two litters side by side across the back of the truck with the litter handles resting on the sides of the truck.

#### CAUTION

When the route of evacuation is along narrow roads or trails, care must be taken to prevent the litter handles from catching on vegetation or buildings.

- Secure the litters to the vehicle.
- Place one litter lengthwise, head first, in the bed of the truck. Secure it in place.
- Leave tailgate open. It is supported by the two tailgate chain hooks.

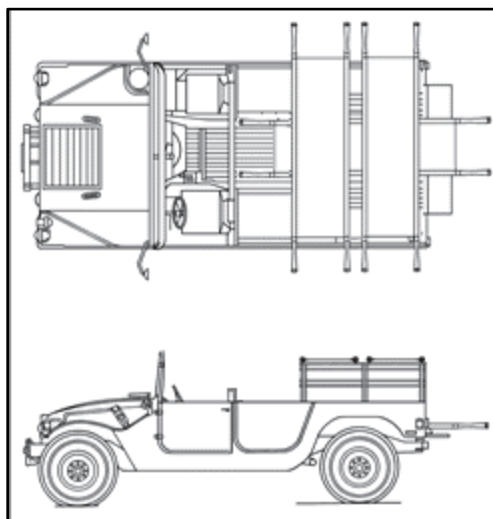
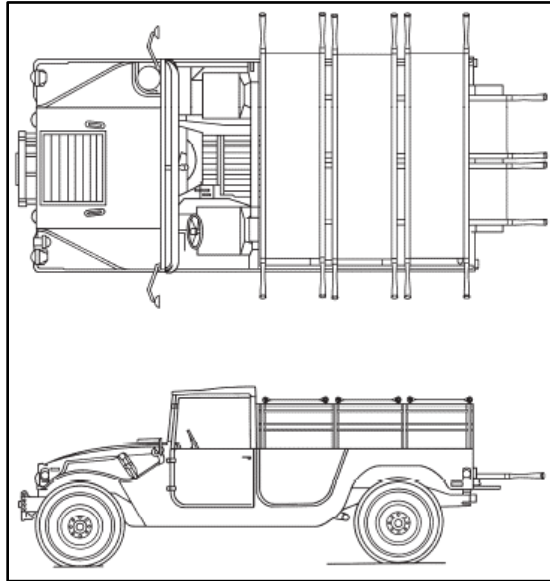

**Figure 4-1. M998 truck, cargo/troop carrier 1 1/4-ton, high-mobility multipurpose vehicle (four-person configuration), with three litters**

#### **M998 TRUCK, CARGO/TROOP CARRIER, 1 1/4-TON, HIGH-MOBILITY MULTIPURPOSE WHEELED VEHICLE (TWO-PERSON CONFIGURATION)**

4-5. The M998 HMMWV, 1 1/4-ton cargo truck in the two-person configuration (figure 4-2), can be easily adapted for transporting five litters. To convert this vehicle to carry patients or casualties, the procedures listed below should be followed:

- Fold the fabric cover and metal bows forward and together as an assembly. Secure them in place. Lower the tailgate.
- Place three litters side by side across the sideboards. Secure them in place with cargo tie-downs, cravats, or other suitable sturdy materials.
- Place two litters' lengthwise, head first, in the bed of the truck. Secure them in place.
- Leave tailgate open. It is supported by the two tailgate chain hooks.



**Figure 4-2. M998 truck, cargo/troop carrier 1 1/4-ton, high-mobility multipurpose wheeled vehicle (two-person configuration), with five litters**

### **M1093 TRUCK, CARGO, MEDIUM TACTICAL VEHICLE, 5 TON**

4-6. The M1093 medium tactical vehicle (MTV), 5-ton truck (figure 4-3 on page 4-4), is normally used to transport general cargo as well as personnel. It has a canvas cover, removable tarpaulin braces, and hinged sideboards. The canvas cover and braces need not be removed for patient loading and unloading. This vehicle has a maximum capacity of eight litters and 14 ambulatory patients or casualties.

4-7. Use the following steps to load patients into this vehicle:

- Lower the seats and secure the vertical support bracket in place.
- Place three litters (litter numbers 1 through 3) crosswise on the seats, forward, next to the cab. Secure the litters individually to the seats.
- Place two litters (litter numbers 4 and 5) lengthwise on the floor, forward toward the cab, feet first. Secure the litters together and to the vertical seat support.
- Place litter number 6 crosswise on the seats near the rear of the vehicle. Slide the litter as far forward as possible. Do not secure the litter at this time.
- Place litter number 7 crosswise on the seats near the rear of the vehicle, and slide it forward as in the step above. Secure the litter to the seats.
- Place litter number 8 crosswise on the seats as far rearward as possible. Secure the litter to the seats.
- Glide litter numbers 6 and 7 rearward next to litter number 8. Secure the litters to the seats.
- Raise and secure the tailgate.
- Position the combat medic/combat lifesaver, if available, in the center of the vehicle to monitor the patients or casualties.

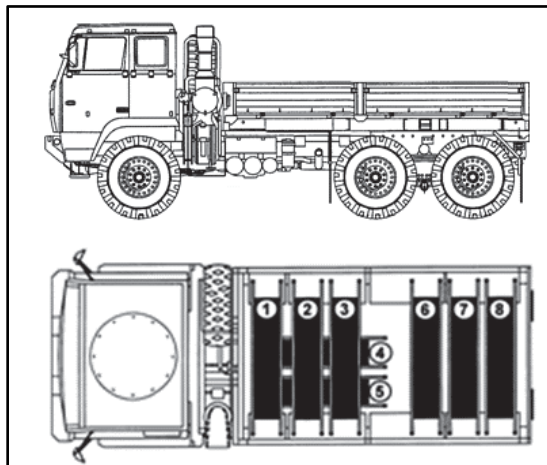

**Figure 4-3. Loading the M1093, medium tactical vehicle, 5 ton**

### **M1081 TRUCK, CARGO, LIGHT MEDIUM TACTICAL VEHICLE, 2 1/2-TON**

4-8. The M1081 light medium tactical vehicle (LMTV), 2 1/2-ton truck (figure 4-4), is normally used to transport general cargo and personnel. It has a canvas cover, removable tarpaulin braces, and hinged sideboards. The canvas cover and braces need not be removed for patient loading and unloading. This vehicle has a maximum capacity of 7 litters and 12 ambulatory patients or casualties.

4-9. Use the following steps to load patients into this vehicle:

- Lower the seats and secure the vertical support bracket in place.
- Place three litters (litter numbers 1 through 3) crosswise on the seats, forward, next to the cab. Secure the litters individually to the seats.
- Place two litters (litter numbers 4 and 5) lengthwise on the floor, forward toward the cab, feet first. Secure the litters together and to the vertical seat support.
- Place litter number 6 crosswise on the seats near the rear of the vehicle. Slide the litter as far forward as possible. Do not secure the litter at this time.
- Place litter number 7 crosswise on the seats as far rearward as possible. Secure the litter to the seats.
- Slide litter number 6 rearward next to litter number 7. Secure the litter to the seats.
- Raise and secure the tailgate.
- If available, the combat medic/combat lifesaver rides in the center of the vehicle to monitor the patients or casualties.

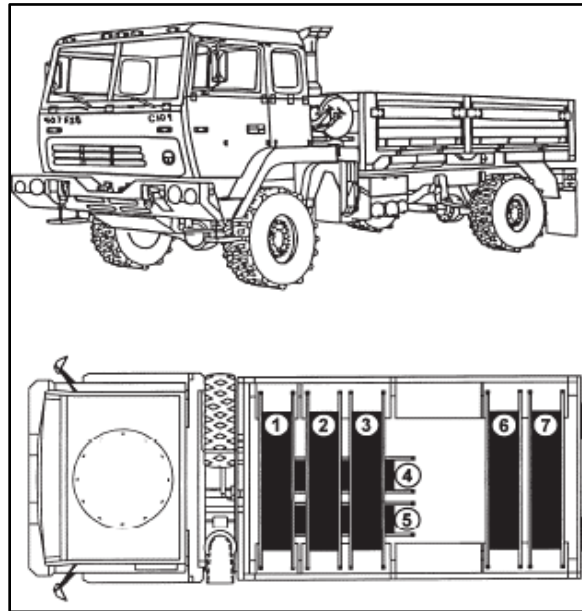
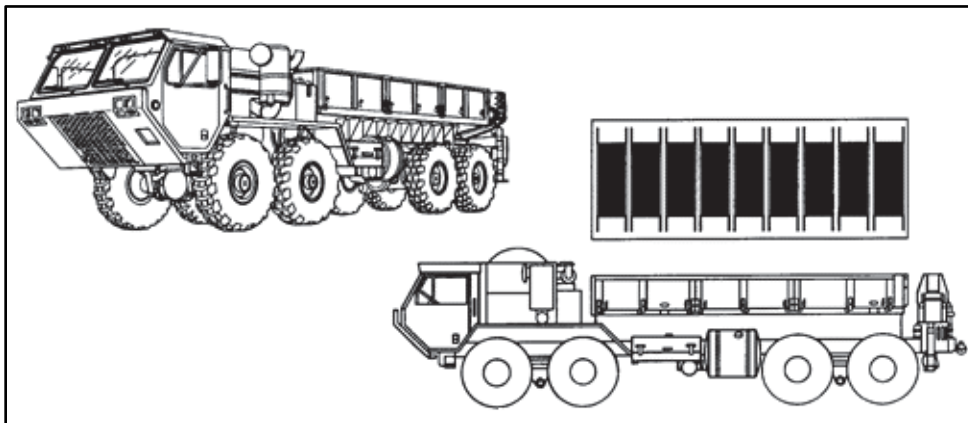

**Figure 4-4. Loading the M1081, light medium tactical vehicle, 2 1/2-ton**

### **M977 HEAVY EXPANDED, MOBILITY TACTICAL TRUCK, 8 X 8, CARGO**

4-10. The M977 heavy expanded, mobility tactical truck (HEMTT) (figure 4-5 on page 4-6), is normally used to transport heavy cargo. The HEMTT may or may not have the cargo cover kit consisting of the cover, stakes, and bows installed. The HEMTT has collapsible sides and can be used to transport the wounded in a MASCAL situation. The HEMTT can be adapted to carry a maximum of nine litter patients or casualties in one lift. Instructions for the loading of the HEMTT are as follows:

- Start at the rear of the HEMTT; roll the cargo cover (if it is on the vehicle) toward the front of the vehicle. Remove the corner lock pins and raise the panel latches to lower the rear section of the cargo body. Remove the first two bows and drop one side of the cargo bed. This will be the side used for casualty loading.
- Place one litter team in the back of the cargo bed to arrange and secure the litters. The second litter team will carry and place the litters into the cargo bed.
- Load the litters from front to back, head to toe, and the less serious to the most serious based on casualty triage. The litters will be placed horizontally on the cargo bed (figure 4-5 on page 4-6).
- Raise and secure the side panel to ensure litter stability and casualty safety. Replace the bows and reroll the canvas cover, if necessary, to provide protection from the elements.



**Figure 4-5. M977 Heavy expanded, mobility tactical truck, 8 x 8, cargo**

### **M1075A1, PALLETIZED LOAD SYSTEM AND M1120A4, LOAD HANDLING SYSTEM**

4-11. Both the M1075A1, Palletized Load System and the M1120A4, Load Handling System, can support CASEVAC operations when equipped with a flat rack (figure 4-6). The flat rack is approximately 8 feet wide and 20 feet long and supports multiple litters. Use of either system for litters is not recommended when the flat rack is not attached due to a lack of usable space on the vehicle. Evacuating ambulatory patients without the flat rack attached would displace crew members from the cabin of the vehicle.



**Figure 4-6. M1075A1, Palletized Load System**

### **M871, 22 1/2-TON, CARGO SEMITRAILER**

4-12. The 22 1/2-ton cargo trailer (Figure 4-7) is attached to a prime mover such as an M800 or M900 series tractor for the transport of general cargo. There are no major differences between the M871 and the M871A1 semitrailers. It has 4 1/3 foot high wooden sides with a canvas trailer cover. This trailer can be used to transport wounded in a MASCAL situation. It can be adapted to carry 16 litters in a single lift. Instructions for the loading of this trailer are to—

- Remove the tie-downs that secure the canvas cover and roll it forward toward the front of the trailer.
- Remove the rear panels exposing the trailer bed.
- Use one litter team in the cargo bed to arrange and secure the litters in the cargo area, while another litter team lifts the casualties to the bed of the trailer.

- Load litters from right to left, front to back, based on casualty triage. The more seriously injured are loaded last so that they are unloaded first.
- Place litters lengthwise, with casualties in a head-to-toe configuration.
- Replace the rear doors to ensure the security of the litters.
- Reroll the cargo cover 3/4 of the way down and then secure the cover to protect the casualties.

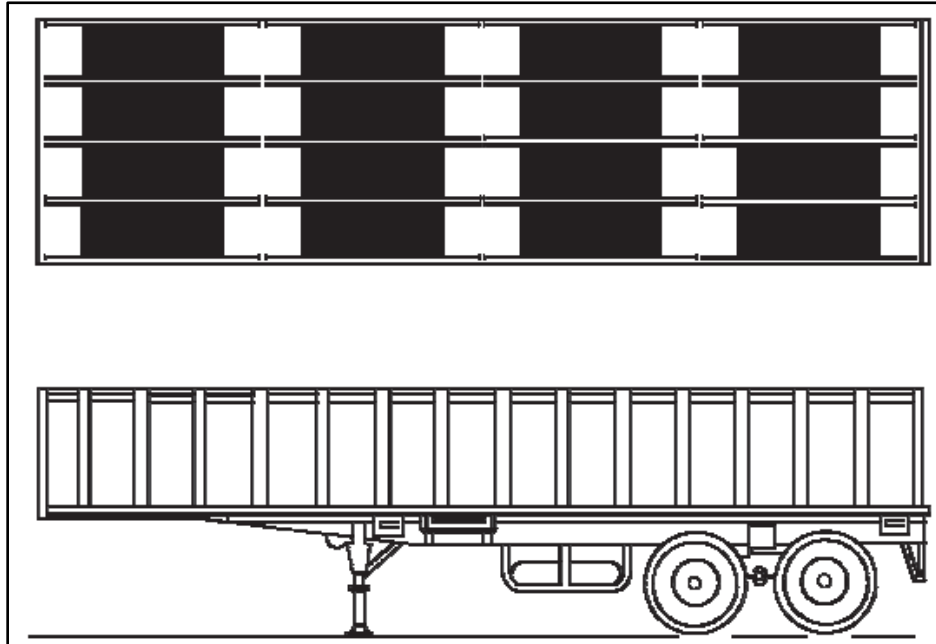

**Figure 4-7. M871, 22 1/2-ton, cargo semitrailer, loaded with litters**

### **MINE-RESISTANT AMBUSH PROTECTED**

4-13. Mine-resistant ambush protected (MRAP) vehicles (figure 4-8 on page 4-8) were designed to increase safety of troops operating in an environment heavy with mines, improvised explosive devices, and ambushes. The term MRAP applies to vehicles made by different manufacturers with shared capabilities. The MRAP has a 300-mile range and can operate safely on hard surfaces and secondary roads. There are several limitations to the MRAP including soft soil issues, poor visibility, and limited maneuverability. There are currently several different MRAP variants in service. Soldiers and leaders must be familiar with the MRAP variants and how best to load, secure, and transport casualties. The four MRAP variants and capacities are—

- The MRAP all-terrain vehicle is the smallest with a capacity of five passengers including the gunner. There are a number of MRAP (CAT) variants.
- The MRAP CAT I is a fire team-sized vehicle with a capacity of seven passengers including the driver and gunner. The MRAP CAT I serves as an armored personnel carrier and supports medium and heavy machine guns.
- The MRAP CAT II supports multiple missions such as troop transport and utility vehicle. The MRAP CAT II has a capacity of 11 passengers.
- The MRAP CAT III vehicles transport six personnel and are equipped for mine and explosive clearance and disposal.



**Figure 4-8. Mine-resistant ambush protected vehicle**

## **STRYKER**

4-14. The Stryker family of vehicles (figure 4-9) uses a common eight-wheeled chassis to provide maneuverability to a rapid deployable platform with increased survivability. The Stryker family of vehicles includes specialized variants for a number of roles however, not all are able to be used as a CASEVAC platform such as the Mortar Carrier Vehicle. The Stryker variants include the following:

- Infantry Carrier Vehicle (also known as ICV): M-1126 and M-1256. The Infantry Carrier Vehicle-Javelin (also known as ICV-J): M-153 has a Common Remotely Operated Weapons system (CROWS)-Javelin missile attachment.
- Reconnaissance or Scout Vehicle (also known as RV): M-1127.
- Commander's Vehicle (also known as CV): M-1130 and M-1255. The Commander's Vehicle is only used at battalion level and above. Company level uses the Infantry Carrier Vehicle with command and control equipment.
- Fire Support Vehicle (also known as FSV): M-1131A1 and M1251.
- Engineer Squad Vehicle (also known as ESV): M-1132 and M-1257.
- Antitank guided missile vehicle (also known as ATGM): M1134 and M-1253.
- Nuclear, Biological, Chemical Reconnaissance Vehicle (also known as NBCRV): M-1135.
- Infantry Carrier Vehicle-Dragon: XM-1296.

4-15. Stryker brigade combat team weapons troop platoons lack ability to CASEVAC independently. The antitank guided missile (also known as ATGM) and the mobile gun system (also known as MGS) can support one litter for CASEVAC or one ambulatory patient. The infantry carrier vehicle (also known as ICV) can support two litters or eight ambulatory patients, or a combination of one litter and four ambulatory patients.





**Figure 4-9. M-1126 Stryker infantry carrier vehicle**

#### **JOINT LIGHT TACTICAL VEHICLE FAMILY OF VEHICLES**

4-16. The Joint Light Tactical Vehicle (JLTV) (figure 4-10 on page 4-10) family of vehicles is a program to replace a portion of the Army fleet of light tactical wheeled vehicles. There are currently two variants, the four-seat Combat Tactical Vehicle (also known as CTV) and the two-seat Combat Support Vehicle (also known as CSV). There are four models, none of which can currently support a litter patient. The CASEVAC capabilities and capacities for each variant are as follows:

- M-1278, JLTV-UTL (Heavy Guns). The M-1278 has four seats and does not support a litter. Carrying any ambulatory patients will displace a crew member. The maximum number of ambulatory patients supported is three, leaving one seat for the driver.
- M1279, JLTV UTL (Utility). The M-1279 does not support a litter and can only support 1 ambulatory patient.
- M-1280, JLTV GP (General Purpose). Like the M-1278, the M-1280 does not support a litter and has a maximum ambulatory patient capacity of three.
- M-1281 JLTV (Close Combat Weapons Carrier). Like the M-1278, the M-1281 does not support a litter and has a maximum ambulatory patient capacity of three.



**Figure 4-10. Joint light tactical vehicle**

## **ALL-TERRAIN UTILITY VEHICLES**

4-17. The family of small all-terrain vehicles such as the aviation light utility mobile maintenance cart (NSN 1740-01-632-9476) as well as other all-terrain vehicle variants currently in service, provide a capability as light capacity tactical vehicles (figure 4-11). These vehicles provide a wide range of functionality and are used for a variety of utility work and the transportation of supplies and equipment. With minimal modification they can easily carry casualties and litters. Depending on how the vehicle is equipped, litters can be secured to the forward cargo rack or to the rear bed. Units that include these vehicles in their inventory and CASEVAC plan will need to train on how best to load and secure casualties and litters.



**Figure 4-11. Military utility vehicle**

## SECTION II – ARMY NONMEDICAL AIRCRAFT

4-18. Army nonmedical aircraft include fixed-wing and rotary-wing aircraft. Fixed-wing aircraft are not as available or as numerous compared to rotary-wing aircraft. Rotary-wing aircraft are better suited for CASEVAC purposes.

### ARMY FIXED-WING AIRCRAFT

4-19. Army fixed-wing aircraft are low density, not widely available, and have limited capacities but may be used for CASEVAC operations in some situations where the necessity to move over a long distance in a short period of time is paramount.

#### C-12 HURON

4-20. The C-12 Huron (figure 4-12) is used to move personnel and cargo. Depending on the model, the C-12s normal cruise speed ranges from 275 to 300 miles per hour with a maximum range of 1,400 nautical miles. It is capable of carrying eight ambulatory patients. There is no litter configuration for this aircraft however, the interior is removable.



Figure 4-12. Cargo-12 Huron

#### C-26 METROLINER

4-21. The C-26 Metroliner (figure 4-13) is used for movement of personnel and cargo. This aircraft is not normally used as an evacuation vehicle but in emergencies it can carry 14 ambulatory patients or be configured to evacuate up to six litter patients. Configuration for litter patients requires time and should be considered during planning. The C-26s normal cruise speed is 245 miles per hour with a maximum range of 1,400 nautical miles.



Figure 4-13. Cargo-26 Metroliner

## UC-35 CITATION

4-22. The primary mission of the Utility Cargo (UC)-35 (figure 4-14) is the movement of personnel and its limited cargo carrying ability. The normal cruising speed is 410 miles per hour with maximum range of 1,500 nautical miles. In emergencies, the UC-35 can carry 2 litters or 7 ambulatory patients. The UC-35 is equipped with a clam-shell cargo door.



**Figure 4-14. Utility Cargo-35 Citation**

## LOADING PATIENTS ABOARD ARMY FIXED-WING AIRCRAFT

4-23. The personnel who transport patients to the landing strip also load the patients aboard the aircraft. They may be required to assist in configuring the aircraft for litters. Litters are generally loaded from the top downward and from the front to the rear. The four-man litter squad plus the crew chief normally load these aircraft. The crew chief or another member of the aircraft crew supervises the loading of all patients. One or all of the litter bearers, depending on the aircraft normally enters the aircraft to assist the crew chief in loading the litters.

## ARMY ROTARY-WING AIRCRAFT

4-24. Army rotary-wing aircraft provides a flexible asset on the battlefield for the use in CASEVAC. The number of patients or casualties that can be transported varies by the type of aircraft and their configuration. For information on aircraft dimensions refer to ATP 3-04.1 and for LZ requirements refer to FM 3-21.38.

## CARGO HELICOPTER-47 (CHINOOK)

4-25. The Cargo Helicopter (CH)-47 (Chinook) is a multimission, heavy-lift transport helicopter. Its primary mission is the transportation of cargo, troops, and equipment on the battlefield during the day or night under all flight conditions. Among its multimission profiles is the movement of patients or casualties along with medical personnel.

4-26. Loading patients aboard the CH-47 with the litter support kit installed allows for a maximum capacity of 24 litter patients or 31 ambulatory patients. The 31 ambulatory patients are seated in the ten three-man seats, and the one-man seat as shown in (figure 4-15). The two one-man seats may be used by crew members. When carrying 24 litters, the seats are replaced with six tiers of litters, four litters high as shown in (figure 4-16). The two one-man seats in the rear section should remain in place for the crew members. The one-man seat at the left front may also be left in place provided it is needed. All passengers and cargo loading will be

at the direction of the crew. Refer to TM 1-1520-271-10-1 for additional information regarding litter configuration for the CH-47.

4-27. The combinations of litter and ambulatory patients that the CH-47 is capable of accommodating are provided in (table 4-1 on page 4-14).

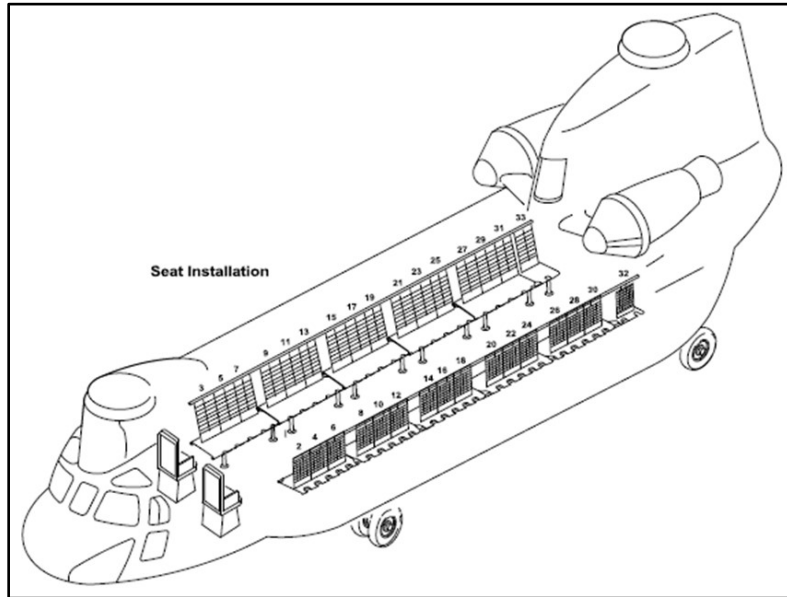

Figure 4-15. Interior view of Cargo Helicopter-47 (Chinook) with seat installation

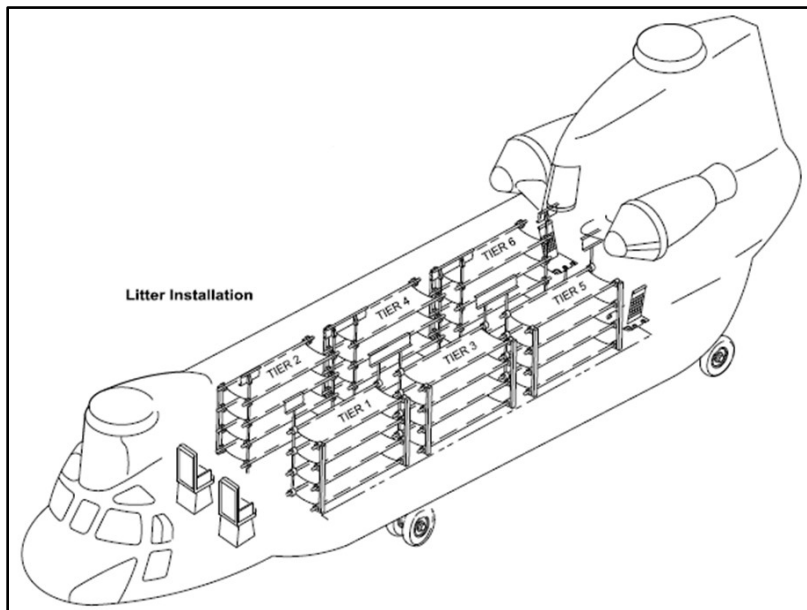

Figure 4-16. Interior view of Cargo Helicopter-47 (Chinook) with litter installation

**Table 4-1. Litter and ambulatory configuration of the Cargo Helicopter-47 (Chinook)**

<i>Ambulatory Patients</i>	<i>Litter Patients</i>
31	0
25	4
19	8
16	12
10	16
4	20
1	24

**UTILITY HELICOPTER-60 (BLACKHAWK)**

4-28. Utility Helicopter (UH)-60 Blackhawk (figure 4-17) is a multimission, medium-lift transport helicopter. Its primary mission is the transportation of troops, cargo, and equipment on the battlefield during the day or night and under all flight conditions. This utility tactical transport helicopter provides air assault, general support, command and control, and special operations support.

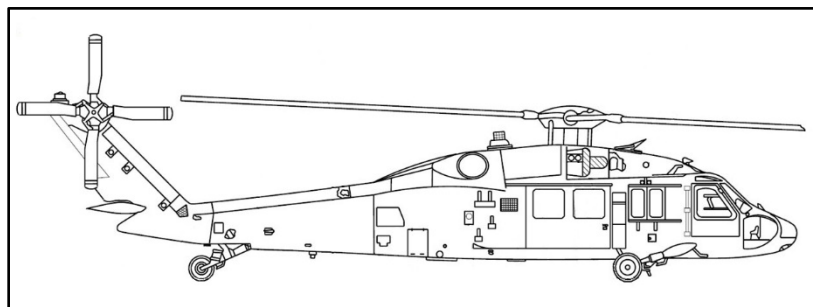
**Figure 4-17. Utility Helicopter-60 (Blackhawk)**

4-29. The UH-60 is the Army's primary MEDEVAC helicopter. For information on the utilization of the UH-60 in the role of medical evacuation refer to ATP 4-02.2.

4-30. In the CASEVAC role, the UH-60 is capable of transporting both ambulatory and litter casualties. The numbers of both vary with the aircraft's configuration. To safely secure litters on the floor of the UH-60 and other aircraft with appropriate floor cargo, use attachment points, the strap, tie-down, universal litter (NSN 6530-01-530-3860) and the CASEVAC conversion kit, aircraft (NSN 6545-01-536-9315). These are available through the military supply system and commercial vendors. These kits provide a means to secure a litter and patient or casualty to the floor of the aircraft and the ability to transfer the casualty to an air or ground ambulance for movement to an MTF.

---

*Note.* When the standard litter is placed in the UH-60 perpendicular to the aircraft's forward and aft axis, the cargo doors will not close. In this position a litter with collapsible handles must be used.

---

**LIGHT UTILITY HELICOPTER-72 (LAKOTA)**

4-31. The Light Utility Helicopter (LUH)-72 (Lakota) (figure 4-18) is a commercial aircraft designed to conduct light general support tasks in permissive, noncombat environments. The LUH tasks include civil search and rescue, personnel recovery, counterdrug, and limited civil command and control operations in the conduct of homeland security.



**Figure 4-18. Light Utility Helicopter-72 Lakota**

4-32. As a CASEVAC platform, the LUH-72 can accommodate a limited number of litters and ambulatory casualties. These numbers depend on the LUH's configuration, it will accommodate a maximum of two litters or a maximum of six ambulatory passengers, or a combination of one litter and 3 ambulatory patients.

### **SECTION III – ARMY WATERCRAFT**

4-33. Army watercraft provide a flexible capability that are self-deployable, transoceanic or prepositioned, and may operate in permissive and nonpermissive environments. Army watercraft conduct a wide range of missions including:

- Movement and maneuver of combat forces.
- Expeditionary sustainment operations.
- Riverine operations.
- Force projection.
- Humanitarian assistance and disaster relief.
- Over the shore logistics.
- Non-combatant evacuation operations.

4-34. Army watercraft possess a range of limited organic medical capability, depending on the watercraft class. Some watercraft, such as Class A-2, must carry a certified emergency treatment noncommissioned officer and carry medical supplies for routine and emergency medical treatment. Class A-2 Army watercraft include the logistics support vessel (LSV). Class A-1 Army watercraft have the same requirements as Class A-2 while operating in oceans but otherwise, only require a combat lifesaver with medical supplies for emergency treatment. An example of a Class A-1 Army watercraft include the landing-craft, utility (LCU2000). For more information on Army watercraft classifications and requirements, refer to AR 56-9.

4-35. Any planned use of Army watercraft for CASEVAC purposes should include for the provision of combat medics or combat lifesaver trained personnel to provide en route monitoring and treatment of casualties. Prior planning is critical to coordinate commands and actions on the watercraft, proper loading and securing of litters. Many Soldiers have little or no experience with Army watercraft so training and rehearsals are necessary to prevent accidents and injuries. Personal flotation devices should be provided to the casualty before loading if injuries permit, and care should be taken to avoid causing further harm to the casualty. In addition, on-board personal floatation devices are primarily for the crew and insufficient in number for large numbers of casualties. Prior planning is required to ensure enough personal floatation devices are available.

4-36. Casualty movement from a vessel or other platform on the water requires special considerations. Specific instructions may be found in TM 4-15.21. Casualty movement between platforms cannot be avoided at sea, whether the patient is evacuated to another vessel, or by rotary-wing aircraft. Minimizing movement caused by seas is possible by circling a small area. The seas inside the circle will calm enough to better facilitate the evacuation. Refer to ATP 4-15, for watercraft draft and speed considerations.

4-37. A stokes litter (rescue blanket with flotation logs, securing straps, and lifting slings) is the preferred device and are available on Army and Navy vessels as well as Coast Guard aircraft for conducting CASEVAC over water. If a stokes litter is available, it should be readied prior to loading the casualty. If a rescue blanket is lowered from the aircraft, litter bearers must wait until the basket touches the deck before approaching it, to allow for static discharge. Tending lines will enable litter bearers to steady the litter during transfer.

## LOGISTICS SUPPORT VESSEL

4-38. The LSV is the Army's largest powered watercraft and provides worldwide and intratheater transport of combat troops, vehicles, supplies, and equipment. The LSV (figure 4-19) can operate from advanced bases, ports, harbors, undeveloped coastlines, inland waterways, and unimproved beaches. The LSV has bow and stern ramps for beach landings and to facilitate roll-on and roll-off cargo movement. The LSV is 273 feet in length with a deck area of 10,500 square feet. The LSV range (loaded) is 6,500 miles and speed (loaded) is 11.5 knots. The payload of the LSV is 2,000 short tons, and capacity enough for 24 M1A2 tanks. The LSV can support an estimated 300 litters or 500 ambulatory patients. An example of the litter configuration is located in (figure 4-20).



**Figure 4-19. Logistics support vessel**



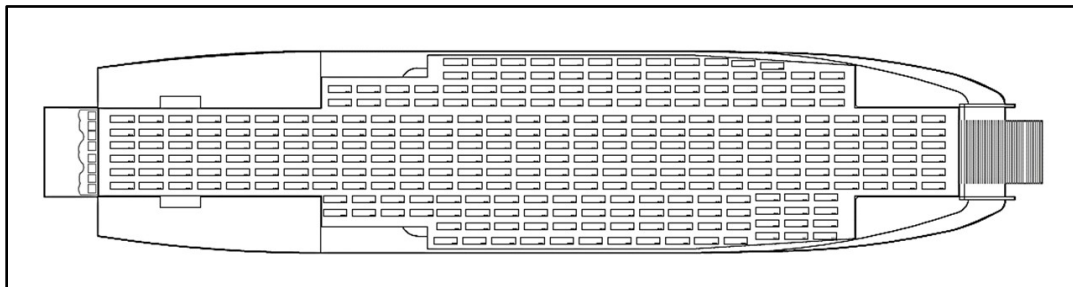

**Figure 4-20. Example of a Logistics support vessel with litters**

## **LANDING CRAFT, UTILITY 2000**

4-39. The landing craft, utility 2000 (LCU 2000) provides worldwide and intratheater transport of combat troops, vehicles, supplies, and equipment. The LCU2000 (figure 4-21) conducts intratheater movement from advanced bases and strategic sealift ships to ports, harbors, undeveloped coastlines, inland waterways, and unimproved beaches. The LCU2000 has a bow ramp for beach landings and to facilitate roll-on and roll-off cargo movement. The LCU2000 is 174 feet long with a deck area of 2,500 square feet. The LCU2000 range is 6,500 miles and speed (loaded) is 10 knots. The payload of the LCU2000 is 350 short tons, and capacity enough for 5 M1A2 tanks. The LCU2000 can support an estimated 92 litters or 250 ambulatory patients. An example of this litter configuration is located in (figure 4-22 on page 4-18).



**Figure 4-21. Landing craft, utility 2000**

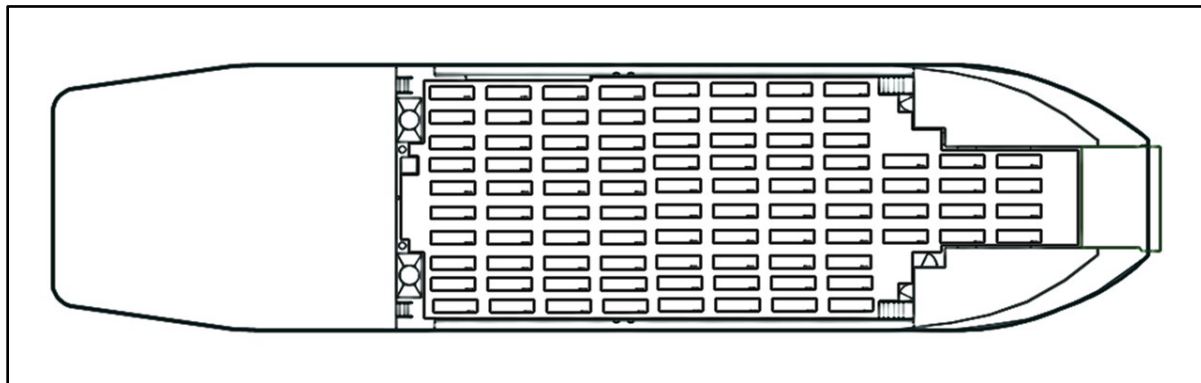

Figure 4-22. Example of landing craft, utility 2000, with litters

## LANDING CRAFT, MECHANIZED 8

4-40. The landing craft, mechanized 8 (LCM8) provides transport of cargo, vehicles, personnel, and can operate as diver support, firefighting, or command and control platforms. The LCM8 (figure 4-23) operates from deep strategic sealift ships or in retrograde movement to ports, harbors, undeveloped coastlines, inland waterways, and unimproved beaches. The LCM8 has a bow ramp for beach landings and to facilitate roll-on and roll-off cargo movement. The LCM8 is 74 feet long with a deck area between 620 and 629 square feet, varying from Mod 1 and Mod 2. The LCM8 range is 271 nautical miles and speed (loaded) is 9 knots. The payload of the LCM8 53 short tons. The Mod 2 has accommodations for up to 50 passengers. The LCM8 can support an estimated 10 litters or 25 ambulatory patients.



Figure 4-23. Landing craft, mechanized 8

## SMALL TUG 900

4-41. The small tug 900 (ST 900) transports and repositions cargo, fuel barges, and various vessels in harbors, and ports using inland waterways and coastlines. The ST 900 assists larger tugs in docking, undocking, and towing operations of ships and watercraft. The ST 900 is 60 feet in length and 22 feet wide. The ST 900 speed is 6 knots with a range of 720 nautical miles. The ST 900 has very limited use as a CASEVAC platform compared to other Army watercraft due to its small size and lack of usable deck space.

## LARGE TUG

4-42. The large tug 128 (LT 128) conducts coastal and ocean towing, docking, and undocking operations with large ocean vessels including recovery of disabled and damaged Army watercraft. The LT 128 is 128 feet in length and 36 feet wide. The LT 128 has a range of 5,000 nautical miles and a speed of 12 knots (loaded). The LT128 has very limited use as a CASEVAC platform for the same reasons as the ST 900, but has a small deck space.

## MODULAR CAUSEWAY SYSTEMS

4-43. Modular causeway systems include the causeway ferry (figure 2-24) and warping tug (WT) (figure 2-25). These are not recommended as CASEVAC platforms due to the lack of protection from sea state. In severe circumstances, a causeway system could be utilized as a casualty staging area in preparation for evacuation.



**Figure 4-24. Causeway ferry**

## WARPING TUG

4-44. The warping tug (WT) provides movement and positioning of non-powered modules, sections, floating causeway and roll-on roll-off discharge facility. The WT (figure 4-25) sets and retrieves anchor moorings and conducts other weight handling and towing tasks. The WT is 80 feet long and 24 feet wide. The WT has a speed of 8 knots and is not used for extended voyages. The WT has a payload of 13.5 short tons.



**Figure 4-25. Warping tug**

## SECTION IV – ALTERNATIVE PLATFORMS

4-45. Alternative platforms include any vehicle that can be utilized to evacuate casualties to a CCP, MTF, AXP for further MEDEVAC, or an access point or destination. Ground CASEVAC is normally conducted by unit vehicles, however, in large-scale combat operations, the number of casualties may require an alternative means as evacuation demands will exceed available MEDEVAC and CASEVAC platforms.

### EVACUATION BY RAIL

4-46. Trains have been used in the movement of casualties since the Crimean War in 1855. The United States (U.S.) Army first used trains as a CASEVAC platform during the American Civil War where both Union and Confederate armies used trains to move casualties from the battlefield to urban centers. The U.S. Army used rail cars during both world wars for CASEVAC and MEDEVAC and last used trains during the Korean War. While the use of trains fell out of use in the U.S. Army, planners have to be prepared to use all capabilities at their disposal when planning for large-scale combat operations.

4-47. In an emergency, practically any type of train car can be used as a CASEVAC platform. Evacuation by rail is slower than many other conveyances. However, it is capable of moving large numbers of casualties. Movement by train is more suitable for ambulatory patients who can tolerate longer distances. Railways may remain clear while road networks are damaged, limited, or congested with displaced personnel. Rail cars used for CASEVAC during both world wars were eventually replaced with MEDEVAC rail cars as part of a large multi-modal system but were initially austere and primitive. Some Soldiers were evacuated from the battlefield on flatcars with only straw as padding. This eventually evolved into a deliberate ambulance system with attending medical staff.

4-48. In all instances, every effort is made to provide maximum possible comfort for the patients or casualties. Evacuation on rail may require additional padding to protect casualties from further injury. Modern passenger cars (standard sleepers, chair cars, or baggage cars) may be preferable because they offer protection from the elements, provide climate control, and possess some cushioning. Passenger cars also have latrines.

4-49. There are a number of different passenger cars so planners must be aware of regional transportation capabilities when incorporating this capability into CASEVAC plans. When moving casualties in passenger cars, the ambulatory patients make efficient use of seats while sleeper cars are better suited for litters. Some sleeping areas may not accommodate standard litters. Some passenger cars may be divided into compartments while others are relatively open with larger seating areas.

4-50. Freight cars come in a wide variety of types. Some of those more practical for CASEVAC include the following with their characteristics:

- Boxcars. Fully enclosed with end or side door access.
- Gondolas. A car with enclosed sides but open top for bulk goods.
- Flatcars. For large loads that include a number of specialized flatcars to carry automobiles, mechanical parts, and building materials.
- Stock cars. A ventilated boxcar for transporting livestock.

4-51. Freight cars will require additional lashing material to secure litter casualties to the car. Medical personnel, if available, should accompany the rail movement to monitor and provide intervention as needed. The combat lifesaver trained Soldiers should accompany the casualties if medical personnel are unavailable, or, to assist medical personnel in monitoring and attending to the large numbers of casualties that freight cars could support.

### EVACUATION BY BUS

4-52. Buses have been modified in the past to move injured or ill U.S. Service members. This capability no longer remains in the Army inventory, but buses are located in most cities and can provide an additional CASEVAC capability.

4-53. Buses are a good CASEVAC platform for intermediate distances (less than 250 miles) and can easily move ambulatory patients. Movement of litter patients may be limited to the floor or other methods depending on the configuration.

4-54. There are a number of different bus designs and capabilities. Most buses can move approximately 38 ambulatory or 18 litter patients. These numbers vary to some degree depending on model and type of bus. Differences include the following:

- An intercity bus has a latrine but only a front door and can hold up to 40 ambulatory casualties.
- A suburban bus has only front doors but lacks the luggage and latrine of the intercity bus. The capacity is similar.
- A transit bus is a bus with front and center doors with a rear mounted engine. These buses can hold 30 to 42 ambulatory casualties depending on vehicle type.
- An articulated bus consists of a rear section connected to the main body by an accordion like joint. This bus can hold up to 60 ambulatory casualties.
- A minibus is manufactured by several companies where a specialty made body is placed on a truck chassis. They have walk-in and front doors. The minibus varies by design and configuration with capacity ranges of 16 to 28 ambulatory casualties.
- A school bus capacity varies by manufacturer and type. A conventional U.S. school bus has 13 rows of seats on each side which can support up to 52 ambulatory casualties.

## **CASUALTY EVACUATION USING CONTRACTED AGENCIES**

4-55. In some operations, contracted agencies may provide a means of providing CASEVAC when conventional ground, air, or sea platforms are unavailable or incapable of supporting CASEVAC operations. Planning for agency provided CASEVAC involves a number of considerations and critical information requirements, and will require more research to assess agency capabilities.

4-56. Some considerations in the use of contracted agencies include, but are not limited to:

- Response time and platform capabilities.
- Transportation restrictions—weather or time based (day or night) restrictions and the cube or weight limitations of the platform.
- Capability to conduct cross-border movement.
- Approval authority to hire and release funds.
- Method of payment (cash, electronic, or credit).
- Ethnic or cultural issues.
- Potential need for “tail-to-tail” exchange of patients between aircraft, especially for extended distances.
- Availability of host nation MTFs and local medical capabilities (some contracted agencies may transport to a predesignated MTF per contract).

4-57. The potential exists that a military medical crew will be needed to augment contracted medical personnel or provide the only en route medical care on a contracted evacuation platform. A contracted CASEVAC platform may have no en route care capabilities. Planners consider these possibilities as methods of mitigating evacuation capability gaps when using contracted agencies.

4-58. Coordination with a contracted agency may require a more hands-on approach compared to using a Department of Defense (DOD) organization to provide CASEVAC. This means the planner or representative should meet with the companies in person whenever possible, especially in urgent situations.

This page intentionally left blank.

## Chapter 5

# Rough Terrain Considerations

Soldiers may encounter natural and man-made hazards when operating in environments such as mountains, urban environments, and subterranean areas that impede movement. Leaders mitigate these obstacles through planning, proper equipment, and realistic training.

### ROUGH TERRAIN

5-1. Rough terrain will require greater effort and manpower to evacuate a casualty. Natural obstacles or hazards including rivers, ravines, cliffs, mountains, gaps, and ditches more than three meters wide create uniquely different challenges. Many man-made obstacles such as canals and embankments will require the same approach as natural obstacles or hazards for CASEVAC. Often, operations in rough terrain will be restricted to dismounted movements on foot. In small units, the evacuation of a casualty may take the efforts of the majority of available Soldiers.

5-2. When planning to negotiate rough terrain hazards, enemy considerations must be analyzed such as:

- How will the enemy use the obstacle or hazard to their advantage?
- Is the enemy reinforcing the hazard (wire obstacle or mine field)?
- Does the enemy have weapons to cover the obstacle or hazard and if so, what type?

5-3. When negotiating an obstacle or hazard, consider how terrain can be used to conceal movement from enemy observation and prevent the enemy from engaging litter teams with direct and indirect fires. Taking a route that offers concealment to negotiate a hazard may take more time but provides a reduced chance of detection.

5-4. The ability to conduct an evacuation may be limited by the tactical situation such as if movement is restricted to periods of darkness or to specific routes. Rivers can be natural obstacles in almost every environment that will require equipping and training for optimal results. The difficulty in negotiating a river and the risk involved varies with depth, width, and strength of the current. River flows may vary, depending on the time of day. Negotiating rivers with litters while dismounted requires more personnel, time, and effort. Training and rehearsals will mitigate some of the risk and the tactical situation must be considered to reduce the possibility of enemy observation and attack.

5-5. Of the earth's land surface, roughly a quarter is mountainous. Mountains may be individual peaks or entire ranges and are characterized by steep slopes, cliffs, glaciers, high peaks, and deep valleys. The types of rocks in mountains can present hazards as some types are easily broken. Deep snowfields may also be encountered along with the risk of avalanches. Flash floods are another hazard due to shallow soil and steep slopes in mountains and may occur with little or no warning. Glaciers may provide the most expedient route to evacuate casualties but they also possess numerous hazards including crevasses, snow bridges, icefalls, and moats, requiring additional planning and equipping. Evacuating a casualty in mountainous terrain is compounded by the environmental characteristics above as well as altitude, weather, and available equipment. For more information on medical evacuation considerations in mountainous terrain, refer to ATP 4-02.2. For more information on mountain operations and a detailed description of associated hazards, refer to ATP 3-90.97, ATP 3-21.50, and TC 3-97.61.

5-6. Urban terrain ranges from villages with populations less than 3,000 to megacities, with populations of 10 million or more people. More than 50 percent of the world population lives in urban areas. Urban terrain may vary greatly in size and physical characteristics and may include features such as multistoried buildings, extensive rubble, and subsurface areas. For more information, refer to ATP 3-06.

5-7. Subterranean systems have unique environmental risks that complicate CASEVAC such as cave-ins, flooding, contaminated air (smoke, debris), and confined areas or space. Subterranean environments are organized in the following categories:

- Tunnels, natural cavities, and caves (rudimentary or sophisticated).
- Urban subsurface systems (basements, subways).
- Underground facilities (bunkers, military bases).

5-8. Operations in subterranean environments, including CASEVAC, require deliberate planning. Casualty evacuation will often be available before medical evacuation is accessible in subterranean environments. For more information on subterranean operations, refer to ATP 3-21.51.

5-9. Rivers are a natural hazard that are found on every continent. River flows may vary seasonally from dry beds to fast moving rapids. River depth and width will vary with topography and some rivers may have been dredged to support movement of heavy river barges, making CASEVAC difficult without proper equipment and training.

5-10. Even if the area in the vicinity of the river crossing is secure, negotiating the hazard can be dangerous to casualty and litter teams. Information on the conditions of the river and surrounding terrain is required to reduce risk during a river crossing. Map reconnaissance provides some information but may not reflect current river conditions, impact of seasonal changes, and weather. Aerial images provide more information, but can miss important information that can only be obtained by a patrol assessing the hazard. Maps and images can quickly become out of date. Some water hazards are home to animals that can cause serious injury. These risks must be identified and mitigated as much as the tactical situation permits.

## **ROUGH TERRAIN PLANNING CONSIDERATIONS**

5-11. General examples of CASEVAC planning considerations are located in Chapter 1 of this publication. For CASEVAC in rough terrain, the following considerations are included into mission planning:

- Identify terrain hazards that may have to be navigated. Dismounted movements will often have to move through natural terrain, often with limited or no access to roads.
- Identify reliable and secure trails or roads that may be used to move casualties.
- Identify areas along route that may be usable as LZs.
- Consider weather conditions and its impact on the chosen evacuation route.
- Augmenting litter teams is recommended whenever possible. Soldiers will tire more quickly when conducting CASEVAC in rough terrain, especially using manual or litter carries. This will reduce the rate of movement and increase risk of being detected and engaged.
- Negotiating rough terrain hazards with a vehicle will slow activities, which increases vulnerability and risk of enemy attack.
- If an operation will be conducted in terrain that includes obstacles found in mountains and urban environments, commanders should consider their litter teams and receive instruction and training in military mountaineering, and be proficient in belaying techniques and the selection of belay points.
- Negotiating rough terrain may require additional equipment. This equipment must be identified early during the planning process in order to provide time to obtain needed items and train Soldiers on their proper use.
- If an operation will be conducted in terrain that includes obstacles found in mountains and urban environments, commanders should consider their litter teams and receive instruction and training in military mountaineering and be proficient in belaying techniques and the selection of belay points.

5-12. Although the terrain is different, hazards found in mountainous environments are similar to those in urban environments and subterranean areas. As a result, some solutions, such as descending a vertical surface with a litter will have applications in multiple environments. High altitude may hinder, or prevent the use of utility helicopters for CASEVAC in mountains while dense urban terrain can also constrain helicopter movement due to high buildings and substantial rubble. Even in the best of circumstances, a helicopter may not have access to a usable landing area or be equipped with a hoist to facilitate an extraction.



5-13. In preparation of an operation, leaders should consider selecting key personnel to attend the Mountain Planners Course provided at the Army Mountain Warfare School located at Camp Ethan Allen Training Site, Jericho, Vermont. This course trains planners and staff on the basic skills required to plan, support, and execute operations in mountainous terrain including specific aspects of CASEVAC and resupply in rough terrain. While the course places emphasis on mountain operations, the skills learned are applicable to rough terrain in other environments as well.

## **TECHNIQUES FOR NEGOTIATING HAZARDS DURING CASUALTY EVACUATION**

5-14. The following techniques may be applied to rough terrain hazards in more than one environment. Procedures for negotiating litters around obstacles are discussed in depth in Appendix B. Leaders ensure their Soldiers are equipped and properly trained before attempting techniques. Some of the skills involved require formal training and many are perishable and require more frequent training to sustain proficiency.

5-15. Success in negotiating hazards is directly related to training and proficiency with equipment. Leaders should identify Soldiers to attend the Basic Military Mountaineer Course at a minimum in preparation for operations in areas where rough terrain hazards may be encountered. Soldiers and combat medics may also attend the Rough Terrain Evacuation Course. This will provide the skills required to care for and safely evacuate an injured Soldier over rough terrain in austere conditions. Both courses are conducted by the Army Mountain Warfare School located at Camp Ethan Allen Training Site, Jericho, Vermont.

5-16. There are several considerations in both low and high angle evacuations. Precise command and control is required for safe operations. All commands should originate from the team leader and commands must be clear, concise, and simple. The following are examples of commands:

- Up.
- Down.
- Stop.
- Direction (left, right) given in relation to the attendant facing up slope.
- Slack (include a length such as 10 feet).
- Tension or up rope.

5-17. The commands include the name of the position in the command such as “main” or “tension on belay.” Roll call is done before raising or lowering operations to ensure everyone is ready. Radios are often necessary not simply for tactical considerations, but also to maintain contact in high winds and once the attendant is over the edge.

## **PACKAGING FOR NEGOTIATING ROUGH TERRAIN**

5-18. There are several principles involving the packaging of a casualty or patient when using a rescue and transport system to negotiate hazards, the most important being “do no further harm.” The nature of the casualty’s injuries must be considered when packaging material is used as padding for protection or for insulation. Examples of available materials include space blankets, sleeping bags, ponchos, and poncho liners as seen in (figure 5-1 on page 5-4).



**Figure 5-1. Casualty packaging**

5-19. It may be more efficient to build access points into the packaging. This enables the casualty to remain packaged and protected while allowing easier access to key areas for reassessing the casualty's status and providing medical treatment.

5-20. The casualty may be partially or completely immobilized. If the casualty has full use of their arms, consider leaving one partially free so they can attend to their own comfort when able. Leaving both limbs free can be dangerous to the attendant and the casualty if they have a stress reaction during the evacuation.

5-21. The casualty should be equipped with eye and head protection whenever the nature of their injury permits. This provides added protection against rocks, debris, or ice dislodged during movement from causing further injury to the casualty.

## **NEGOTIATING HIGH ANGLES**

5-22. Negotiating high angles refers to negotiating over vertical or near vertical terrain often encountered in mountains, glaciers, hills, and urban and subterranean environments. Conducting high angle CASEVAC requires a technical approach and a skilled, synchronized team. The task requires a very solid understanding in concepts, equipment strengths, and anchors. The skills involved are perishable and demands frequent training.

5-23. A rescue and transport system or rigid metal basket is used for high angle evacuation. (Figure 5-2) demonstrates a high angle evacuation of a casualty using a rescue and transport system in a vertical orientation. The litter may be rigged for—

- Horizontal orientation. This is similar to a helicopter hoist configuration and is often used when the nature of the injury makes vertical orientation unsuitable such as pelvic and lower leg injuries.
- Vertical orientation. This is used if the injuries permit because it has a more simple edge transition and better protection from rock fall and other hazards. This orientation requires additional

packaging for the casualty and tie down to minimize movement when evacuation begins. Litter attachment (vertical) for the rescue and transport system should be used in accordance with the user's manual.



**Figure 5-2. High angle casualty evacuation**

5-24. High angle CASEVAC requires a trained team and coordination to avoid injury to self and casualty. The following positions are mandatory for safe evacuation:

- Team Leader has responsibility for the operation, considers all options available, and selects most appropriate technique based on tactical situation and urgency of the injury. The team leader briefs the plan, provides guidance, and oversees the operation.
- Belay the Soldier who manages the belay line.
- Mainline consists of one person or team lowering or raising. Only one person speaks for the team to keep communications clear.
- Edge places edge protection if necessary, keeps the edge area clear of debris, and assists the load over the edge. The edge relays commands between the attendant and personnel above.
- Attendant manages the handling of the casualty and litter during the technical portion of the rescue, ensures the litter is protected, keeps slack out of the system, and when necessary will clean and protect the route.

### **NEGOTIATING LOW AND STEEP ANGLES**

5-25. Low angles range from 35 degrees and below. Steep angles range from 35 to 65 degrees. Low and steep angle obstacles can be found in almost every type of terrain. For example, both Texas and Alaska have hills, mountains, and urban areas where these obstacles would be encountered.

5-26. In a low angle, the majority of the casualty's weight is supported by the ground and ropes. They may be used for safety and to increase mobility. A low angle can require ropes to lower a casualty or be gentle enough to enable a casualty to negotiate the terrain with assistance such as with the supporting carry.

5-27. In a steep angle, the weight is distributed between the ground and the rope system. A steep angle evacuation can be steep enough to require the attendant and casualty to be supported by a rope system while the attendant "walks" the supported litter down the slope.

5-28. Negotiating these hazards can prolong CASEVAC and increase risk of detection and engagement by enemy personnel. As a result, site selection is important to reduce risk as much as possible and expedite the evacuation. The location should avoid areas with loose rock, ice, and other debris that could fall and injure the casualty and attendant. The site should also have reliable anchor points for rope systems. If the route is long, locations for rest or relay points should be selected that provides some concealment and cover if possible.

5-29. Three trained Soldiers is the minimum number recommended to safely negotiate low and steep angles including an attendant to accompany or assist the casualty, a belay, and assistant belay. Increasing the number to five Soldiers is recommended if they are untrained. Successfully evacuating a casualty up or down a low or steep angle may cut the evacuation time by hours compared to using an extended route.

5-30. The attendant does not have to be a combat medic or other medical professional. In situations where the casualty is in a rescue and transport system, it may be more efficient for the combat medic to help prepare the casualty before negotiating the hazard (in this case, a low angle) and then navigate to the point to receive the casualty. This would enable medical personnel to be prepared to reassess and provide treatment if needed.

5-31. The attendant assists and protects the casualty while negotiating the hazard. This helps prevent the casualty from rolling over onto their face and causing further injury. The attendant also assists in moving the casualty around obstacles along the route that could hold up the casualty and result in slack building up in the rope system. Once the slack is removed, the casualty would fall rapidly until coming to a stop which could cause further harm. (Figure 5-3) provides an example of a low angle CASEVAC. (Figure 5-4 on page 5-8) demonstrates a steep angle CASEVAC.



Figure 5-3. Low angle casualty evacuation



**Figure 5-4. Steep angle casualty evacuation**

### **FORDING RIVERS AND STREAMS**

5-32. Fording a river or stream can be a labor intensive and dangerous process. The site to cross a river or water hazard must be selected carefully. The tactical situation must be assessed before evacuating casualties across rivers and water hazards. Some areas or sections may have heavy civilian traffic which can expose or compromise the evacuation. The enemy may have direct observation and fires covering known spots that support mounted or dismounted movement across rivers. The use of obscurants may be needed to conceal movement.

5-33. Evacuation drills of crew and casualties should be included in rehearsals if vehicles will be used to evacuate a casualty across a water hazard. If casualties will be evacuated using manual and litter carries, the tactics, techniques, and procedures used to cross the water hazard are rehearsed when possible to ensure litter teams understand the individual tasks necessary to prevent causing further harm to the casualty. Improvised flotation devices, can be used when others are available including poncho rafts, canteens, and safety belts. Refer to ATP 3-90.98 for more information.

5-34. A good location to ford a river or stream has some of the following qualities:

- Concealment from good areas of enemy observation whenever possible.
- Cover whenever possible.
- Shallow banks to make entering the water easier with less chance of falling or dropping the casualty.
- Fewer large stones as these are often slick and jeopardize footing.
- A sand bar or shallow area along the fording path for litter bearers to rest if needed.

5-35. Rope bridges offer a means of crossing small rivers or streams, especially where there is a strong current. Movement with a litter may require flotation devices if possible. Ambulatory or walking casualties may be able to conduct a crossing with assistance. Refer to ATP 3-90.98 for detailed information on rope bridge types and techniques.

5-36. When conducting a river crossing in the offense, a CCP may be placed at the objective rally point (also called ORP). The first CASEVAC may be backhauled using vehicles returning from transporting Soldiers. Casualty evacuation will be limited until the river is free from direct fire. Medical evacuation capabilities will be limited until the objective is secured after which the Role 1 BAS can move forward across the river which may reduce or remove the need for CASEVAC.

5-37. Those evacuating the casualty must also consider security during movement and be prepared to return fire immediately. Litter team movement is limited, and as a result, litter teams may be engaged by the enemy as an easy target, and damage morale of U.S. personnel. Service members conducting CASEVAC are not usually medical personnel and are not afforded the same protections under the Geneva Conventions (I) and The Law of War as those conducting MEDEVAC.

This page intentionally left blank.



## Chapter 6

# Casualty Evacuation in Specific Environments

This chapter addresses CASEVAC in specific environments or under special circumstances. Casualty evacuation requires planning and synchronization to be effectively carried out. Part of that planning includes how environmental factors and terrain can affect the movement of casualties. This chapter discusses the challenges in moving casualties in mountainous, jungle, desert, extreme cold, and urban terrain. More thorough considerations for medical evacuation in these environments can be found in ATP 4-02.2.

### **MOUNTAINOUS TERRAIN**

6-1. General considerations for mountain operations can be found in ATP 3-90.97 and TC 3-97.61. Mountainous terrain poses great challenges to sustainment operations and complicates movement of casualties. Movement is difficult as existing roads and trails are normally few and unrefined. Major thoroughfares mainly run along terrain features that present steep sloping grades on either side, making them vulnerable to ambushes and attacks. These areas have wide variation in climate and are subject to frequent and sudden climate changes and an altitude relief from 1,000 to 3,000 feet or greater.

6-2. Environmental factors can complicate a casualty's medical condition at higher altitudes. These may include hypoxia-related illnesses, dehydration, cold weather injuries, heat exhaustion, sunburn, and snow blindness. These environmental conditions may worsen the casualty's condition and hasten the requirement for a timely evacuation. Refer to Technical Bulletin Medical (TBM) 505 for a discussion on altitude related illnesses.

6-3. Casualty movement in mountainous terrain can present unique problems. The proportion of litter cases to ambulatory cases increases in mountainous terrain. Ambulatory casualties may not be able to move unassisted over rugged terrain and may require a litter for movement. The movement of litter casualties on rugged and steep terrain may require additional litter bearers. The four-man team may need to be augmented up to a six-man litter team. Lines of communication are extended in mountainous terrain, and distances to an MTF are also increased. These increased distances and lack of road networks may raise the reliance on aviation assets to move casualties. As previously noted, the rugged topography of mountains, limits the number of natural transportation routes for evacuation and makes those routes vulnerable to enemy attack. To assure continued operations, CASEVAC planning in mountainous terrain should identify and plan for the use of all possible land routes within the operations area. All alternative methods of transporting casualties should be planned for and considered. Air movement avoids many of the problems experienced in overland travel, but movement by air has its own limitations. It is severely limited by LZ availability and environmental factors such as weather, altitude, visibility, and ambient lighting for night missions.

### **JUNGLE TERRAIN**

6-4. General consideration for jungle operations can be found in ATP 3-90.98. A jungle is a dense forest in a tropical climate. There are several different classifications of jungles and each presents its own unique problems for the movement of casualties. Generally they all have some common limitations which include thick vegetation, limited road structure, and degraded mobility. Roads in the jungle are usually affected by poor drainage, heavy rainfall, and poor roadbed construction which limit trafficability.

6-5. Environmental factors can complicate a casualty's medical condition. The heat, humidity, and terrain of the jungle can increase the incidence of dehydration, heat injuries, infection, immersion foot, and endemic

disease. These increased disease and infection incidences may worsen the casualty's condition; therefore, timely evacuation is essential.

6-6. Medical treatment and evacuation will often be complicated by the extended distances and inaccessibility due to terrain and vegetation. Soldiers may find it impossible to walk through dense undergrowth. At best, litter teams can carry casualties only a few hundred meters over this rough terrain before needing rest or relief.

6-7. Navigating in the jungle can be very challenging. Soldiers conducting CASEVAC need to have the proper navigation training and navigational aids to assure mission success. Due to the difficulties of ground evacuation in jungle operations a greater emphasis on air evacuation is necessary. In areas where the jungle is too dense to prepare a LZ, a helicopter equipped with a hoist should be requested. Army air ambulances are the only conventional Army rotary-wing aircraft equipped with a hoist but may not be available due to demand and distance. If time permits, a clearing may be made using ordnance to permit access by helicopter. Casualty evacuation may be more expedient using waterways and rivers if they are in the area and U.S. watercraft are available.

## **DESERT TERRAIN**

6-8. General consideration for desert operations can be found in ATP 3-90.99. Arid regions make up about one-third of the earth's land surface, a higher percentage than any other type of climate. Desert terrain varies considerably from place to place, with the primary similarity being the lack of water and its consequential effect on vegetation and terrain.

6-9. Medical considerations can be complicated by environmental factors associated with deserts. This includes the increased incidence of heat injuries and dehydration. Dehydration can also increase incidences of other medical problems: constipation, piles (hemorrhoids), kidney stones, and urinary infections. These conditions can affect the casualty's condition and the circumstance of evacuation.

6-10. Casualty movement and medical support in the desert environment is challenged by remote locations, which can extend the times and distance for evacuation. Dependent on the type of desert environment, trafficability may vary and thereby the means of evacuation will be dependent on the network of (or lack of) roads and trails. Consideration should also be made to provide means to cool and hydrate casualties and evacuators during movement.

## **EXTREME COLD**

6-11. Generally operations in the extreme cold have many of the same limiting factors found in desert operations. The tundra and glacial areas are harsh, arid, and barren. Temperatures may reach lows of 25 Fahrenheit (°F) to -40°F (-20 Celsius (°C) to -32°C) which combined with gale force winds, makes exposure unsurvivable. Refer to ATP 3-90.97 for an in depth review of cold weather operations.

6-12. Medical considerations can be complicated by environmental factors associated with extreme cold. This includes hypothermia, frostbite, nonfreezing cold injuries (chilblains, trench foot), snow blindness (solar keratitis), dehydration, and immersion syndrome. Any injury in a cold environment enhances the risk of circulatory shock due to a reduction in blood flow. Protection of a casualty who is receiving first aid is more difficult due to the increased risk of cold injury if cold-weather clothing is removed. In extreme cold, do not remove clothing until the casualty is in a shelter. The bulkiness of cold weather clothing may obscure other injuries such as exit wounds and fractures. When in shelter, the casualties wounds are exposed and once treated, are covered again. Refer to Technical Bulletin (TBM), Medical 508 and TC 4-02.1 for a full discussion on cold weather injuries.

## **EVACUATION FOR EXTREME COLD**

6-13. Units operating or planning to operate in extreme cold with ground vehicles must have fully mission capable heaters in the troop compartments. Prior planning and resourcing is critical to ensure casualties moved by manual carriers, a litter, or on vehicles are provided with additional clothing, blankets, or other means of remaining warm.

6-14. Casualty movement may have to be sustained for longer periods due to terrain delays and the lack of direct routes of evacuation. During the movement of casualties to an MTF or to an air or ground ambulance, casualties need to be kept as warm as possible; the use of sleeping bags and blankets is recommended. Warming shelters should be established along the lines of evacuation to provide casualties and litter bearers a means to warm themselves. This allows casualties to be monitored for signs of a deteriorating condition and provides the litter bearers with some relief from this arduous task. Casualties with hypothermia require timely evacuation. Litter bearers should ensure that hypothermic casualties remains lying on their back, if the injuries allow it. Bearers should make every attempt not to jar or move the casualty suddenly, and ensure that the casualty does not attempt to assist in the evacuation. For prolonged litter evacuations, a full body vapor barrier system may be appropriate to help mitigate the effects of hypothermia.

6-15. Site selection for LZs in this environment requires additional considerations. The LZs may require a larger area than normally used due to blowing snow during landing and takeoff. This can be reduced by packing the snow on the LZ by either using vehicles such as snow mobiles or Soldiers walking over the area in snowshoes. Even the lighter weight of the Soldiers can have a good effect to compact snow and reduce it blowing.

6-16. Soldiers approaching any helicopter must take into account that they are taller when wearing their snowshoes and the helicopter may squat down in the snow due to the aircraft weight. This reduces the height of the main rotor blade and increases risk of injury or death.

6-17. Traction devices should be worn when moving on trails, individual touchdown points, and loading or unloading areas for vehicles. As snow gets harder, it can become slick especially in areas where the temperatures are above 0°F. In LZs, flying snow pellets and other particulates such as ice chunks can get in Soldiers eyes and cause injury. Goggles must be worn when snow is being blown by wind and ensure all skin is covered. Individual touch down points for helicopters should have trails packed to them.

6-18. Conditions will vary between summer and winter conditions in extreme cold environments. Solid footing can be suspect during either season. Ice and snow cover, and hidden irregularities on the ground can be hazardous. Ice can become very slick in some conditions requiring the use of traction devices on Soldiers feet. During the summer, ground transportation by either vehicle or on foot is severely restricted due to muskeg or bogland on tundra. This mixture of water and dead vegetation limits cross country movement in an environment lacking significant roads and trails. As a result, casualties must be sustained for longer periods of time due to terrain and lack or limited direct lines of evacuation.

6-19. Litter bearers can experience cold fingers quickly because gripping the litter handles squeezes the blood out of their fingers. Litter bearers should be rotated often. A sling can be fashioned to go over the shoulder to bear the weight of the litter and the hands used to stabilize and guide the litter.

## **PACKAGING IN EXTREME COLD**

6-20. Casualties may be packaged for protection from extreme cold using issued or improvised equipment. Medical personnel must consider the need for access to the patient to reevaluate wounds or injuries and to provide care as necessary, especially when the casualty has shifted during movement. Making access points in the packaging will enable the casualty's wounds to be reevaluated without removing all of the packaging and will help retain warmth.

## **Hypothermia and Prevention Kit**

6-21. A hypothermia management and prevention kit (NSN 6515-01-532-8056) is an augmentation for the rescue and transport system or litter. Units operating in mountainous or extreme cold environments can equip their personnel with this light-weight kit to prevent hypothermia during CASEAVC. To use the hypothermia management and prevention kit—

- Open the kit by tearing at the red notched markings.
- Remove self-heating shell liner from packaging to allow it to begin warming. The liner is activated upon contact with air.
- Remove any wet clothing from casualty, and replace with dry clothing if possible.

- Remove the heat reflective shell from the kit and place the casualty inside. Place the hood in position over the casualty's head.

**WARNING**

**The liner should not come into direct contact with the casualty's skin.**

- Place the self-heating shell liner on top of the casualty.
- Wrap and secure the heat reflective shell around the casualty. This will effectively retain the heat generated by the self-heating shell liner.
- Continue to monitor the casualty during evacuation. The casualty can be reassessed by opening the health reflective shell to evaluate injuries or interventions.

### Improvised Hypothermia Packaging

6-22. A hypothermia wrap may be made from commonly available items. In order to package a moderately hypothermic casualty in an improvised hypothermic wrap—

- Lay a poncho on the ground.
- Lay an insulating pad on top of the poncho.
- Lay a closed sleeping bag on top of the insulating pad.
- Lay an open sleeping bag on top of the first one.
- Place the casualty inside. Add a hot water bottle to the chest area. Do not place it directly against the skin. Zip the sleeping bag closed.
- Place the third open sleeping bag on top of the second.
- Fold the poncho around the patient like a burrito.
- Place the packaged casualty onto a litter for evacuation.

6-23. Additional considerations when evacuating a hypothermic casualty include the following:

- Change the environment the casualty is in from cold and wet to warm and dry.
- Replace damp clothing with dry clothing.
- Add a windproof and waterproof layer or place the casualty in a shelter.
- Add extra insulation under and around the casualty.
- Provide the casualty with food and warm liquids if the casualty is able to tolerate them, and the wounds permit it.
- Exercise mildly hypothermic casualties.

## URBAN TERRAIN

6-24. General considerations for urban operations can be found in ATTP 3-06.11. Urban terrain is a topographically complex environment characterized by man-made construction and high population density. Urban terrain may be cities, towns, or urban sprawl, but does not normally include rural settlement such as villages and hamlets. Clearing the urban battlefield of casualties requires the same considerations as does fighting in it. Urban areas can be a warren of crisscrossing streets and alleys, dead ends, and open areas of observation. It is a multidimensional battlefield that includes not only the normal depth, breath, and height in terms of airspace and surface, but the supersurface (both internal and external) and subsurface areas too. The supersurface includes the internal floors or levels (intrasurface areas) and external roofs or tops of buildings, stadiums, towers, or other vertical structures. Subsurface areas are below the surface level (basements, sewers, tunnels, and subways).

6-25. Because urban areas are found throughout the world and in all climates and environments, medical considerations for evacuating casualties in an urban environment can have similar effects on the casualty as those mentioned previously. When an urban area is located in a mountainous, desert, or cold area, the medical

implications that befall those areas can complicate a casualty's injuries and health. Considerations should be made to recognize and reduce these effects. Another consideration is the potential for high casualty rates and the need for CASEVAC under difficult circumstances. The urban environment has the potential to produce large numbers of casualties. These casualties may become separated and isolated from the main force and require additional trained assets to search for and recover them. Planning considerations should be made on how to locate, treat, and recover casualties isolated within destroyed and collapsed structures both above and below ground level.

6-26. Casualty movement should be conducted by the most effective and available means that protects both the casualty and the evacuators. Streets and alleys can quickly become blocked and inaccessible due to rubble and debris. Evacuation routes need to be adequately planned and reconnoitered, to reduce the chances of litter teams becoming disoriented or lost. The positioning and availability of adequate medical resources, evacuation routes, helicopter LZs, and CCPs should be carefully considered in order to make them both accessible to friendly forces, and secure from hostile targeting. Once located and treated, the movement of casualties becomes a personnel-intensive effort. When there are insufficient medical personnel to search for, collect, and treat the wounded, assistance in the form of litter bearers and search teams is required from supported units, as the tactical situation permits. As urban areas may have significant trouble to vehicular movement due to rubble, road conditions, and other obstacles, much of the CASEVAC may require the use of litter teams. When this occurs, a litter shuttle system should be established. The shuttle system reduces the distance that the wounded or injured Soldier has to be carried by a single litter team. This enhances the litter team's effectiveness by providing brief respites and reducing fatigue. Further, the litter teams are retained in the forward areas. They are familiar with the geography of the area and what areas have or have not been searched for casualties

This page intentionally left blank.

## Chapter 7

# Casualty Evacuation in Mass Casualty Situations

Mass casualty situations can exceed the ability of organic and direct support medical assets to effectively treat the numbers of casualties being sustained. To prevent this from occurring, planners should anticipate this possibility and coordinate with area support medical units to help absorb the acute rise in battlefield injuries. Careful planning and coordination will ensure the standard of medical care for injured Soldiers is not compromised.

## MASS CASUALTY SITUATIONS

7-1. Mass casualty situations occur when the number of casualties exceeds the available medical capability to rapidly treat and evacuate them. The battalion surgeon or medical operations officer works with the logistics and operations officer to develop plans and advise the commander on integrating all available resources into an effective MASCAL plan. See Appendix A for an example of a MASCAL standard operations plan.

7-2. The deliberate planning required to prepare for a MASCAL situation identifies assets that will be utilized to move the casualties in advance of an incident. Units should coordinate these assets in advance within the unit's support structure and supporting MTF.

7-3. Effective management of MASCAL situations is dependent on the establishment and rehearsal of these MASCAL plans. There are a number of other variables which can ensure the success of a unit's MASCAL response plan. These include but are not limited to:

- Coordination and synchronization of additional medical support or augmentation such as:
  - Medical and CASEVAC support.
  - Forward resuscitative surgical intervention provided by forward resuscitative and surgical detachments.
  - Established Class VIII resupply.
  - Casualty collection points.
  - Evacuation routes.
  - Ambulance exchange points.
  - Medical personnel resources to provide en route medical care on nonmedical vehicles.
  - Capabilities and locations of MTFs.
- Procedures for medical equipment (litters, patient securing straps, blankets) exchanges.
- Quickly locating the injured and clearing the battlefield.
- Providing effective tactical combat casualty care for the injured.
- Accurate triage and rapid evacuation of the injured to an MTF at the next higher role of care.
- Coordinating with key personnel and units in the use of nonmedical vehicles for medical evacuation or casualty transportation.
- Nonmedical personnel for litter teams identified and trained.
- Maintain trained and equipped combat lifesavers.
- Communications frequencies and call signs synchronizing response.
- Enemy use of weapons of mass destruction and associated MASCAL situations with chemical, biological, radiological, and nuclear hazards present to include:

- Containment of hazards to limit the spread.
- Protection of responders.
- Identification of dirty collection points, evacuation vehicles, and routes.
- Set-up of patient decontamination sites.

7-4. Ground nonmedical assets can be used for CASEVAC when the medical evacuation system is overwhelmed. All available ground vehicles should be considered for augmenting medical evacuation assets in an emergency. The key to success is identifying the vehicles, drivers, and medical personnel or the combat lifesaver who will accompany the casualties. Each of these vehicles should be equipped with a Warrior aid and litter kit (NSN 6545-01-532-4962). The kit is designed to provide the user with enough medical supplies and a stable evacuation platform for two critically injured casualties. Coordinating for the release of these assets upon demand rather than waiting for a MASCAL situation to occur is also crucial to the success of the operation.

7-5. Vehicle types will differ depending upon the type of unit supported; however, some of the more common vehicles which may be used are the—

- Family of medium tactical vehicles:
  - The LMTV.
  - The MTV.
- Truck, cargo, LMTV, 4 x 4, 2 1/2 ton, M1078.
- Truck cargo, LMTV, 2 1/2 ton, M1078 and M1081.
- Truck, cargo, MTV, long wheelbase, 5 ton, M1085 series.
- Truck, cargo, MTV, light vehicle, 5 ton, M1083.
- Truck, cargo, HEMTT, 8 x 8, cargo, M977.
- Semitrailer, cargo, 22 1/2 ton, M871.
- Armored personnel carrier, M2/3 Bradley infantry fighting vehicle, M113, M1133 Stryker, MRAP.
- Tractor, 5 ton, with stake and platform trailer.
- High-mobility multipurpose wheeled vehicle, M998.

7-6. All organizations must have procedures in place to respond effectively to MASCAL situations. The potential for disasters in war and other operations requires that the medical element be prepared to support MASCAL situations. They must be able to receive, triage, treat, and evacuate large numbers of casualties within a short period of time. Contingency plans for supporting MASCAL operations must be developed by all units in coordination with their battalion surgeon, battalion operations staff officer, and logistics staff officer.

## **HOST-NATION SUPPORT**

7-7. Depending on the area of operations, host-nation support agreements may provide evacuation assets ranging from austere to extensive support. Coordination with the civil affairs personnel or the local country team can provide information on the availability of assets. This information should be included in the operation plans. Some of the types of assets which might be available for support are:

- Buses.
- Barges and other watercraft.
- Civilian cargo vehicles.

## **MEDICAL STAFFING IN NONMEDICAL VEHICLES**

7-8. The staffing of nonmedical vehicles with medical personnel to provide en route medical care requires considerable planning and coordination. Since nonmedical vehicles are normally ones of opportunity, medical personnel and equipment and transportation platforms must be carefully tracked if they are to be used. The current medical system lends itself well to this form of task-organizing by providing four-man treatment teams organic to the brigade support medical companies, area support medical companies, and



within most battalion headquarters. Medical operation planners should plan and coordinate to use these assets in this temporary role. Also available within most support organizations are trained combat lifesavers. These personnel can be used, if available, to provide en route treatment of less seriously injured patients.

## CASUALTY MANAGEMENT

7-9. The management of casualties using nonmedical evacuation assets is difficult to control. Prior to moving a casualty, it is important to know where the casualty needs to go. This may be determined by the severity of injuries, number of casualties, and availability of the MTF. Because en route medical care is not provided, the duration of travel that the casualty can withstand without their condition deteriorating must be a consideration. Determining the severity of a casualty’s injuries and patient category can be difficult for nonmedical personnel, therefore, medical personnel should always be utilized for this task when available.

7-10. Casualties should always be transported to the nearest MTF, CCP, or other sites where medical personnel are located. Over evacuation occurs routinely unless controls are implemented to manage the casualty by patient category. Over evacuation is the result of the mistriage of casualties, where the patient is placed into the wrong category which increases the demand on limited evacuation assets. Responsive evacuation is extremely important; however, if an en route patient care and management by patient category are ignored, the end result will be an increase in the mortality rate and an over evacuation of Soldiers that may be returned to duty.

7-11. The more severe casualties (the URGENT and URGENT-SURG precedence casualties) should be evacuated before PRIORITY or ROUTINE precedence casualties. Care must be taken to ensure lower precedence casualties are evacuated before their medical condition begins to deteriorate resulting in upgrading their precedence to URGENT or URGENT-SURG. URGENT and URGENT-SURG precedence patients should be moved by an ambulance providing en route medical care. The URGENT and URGENT-SURG casualty that is being transported by a nonmedical asset, needs to be transferred to an air or ground ambulance at the first opportunity or delivered to a supporting MTF as quickly as possible. Planners should consider and incorporate into the operation plan the use of nonmedical air assets and dedicated ground ambulances to move the PRIORITY precedence casualties, and nonmedical ground vehicles to move the ROUTINE precedence patients when dedicated medical vehicles are not available. Every effort should be made to staff and equip nonmedical vehicles used for CASEVAC with medical personnel, even if only to move the ROUTINE patient precedence category. See Table 7-1 for categories of evacuation precedence.

**Table 7-1. Categories of evacuation precedence**

<b>Priority I—URGENT</b>	Is assigned to emergency cases that should be evacuated as soon as possible and within a maximum of one hour in order to save life, limb, or eyesight and to prevent complications of serious illness and to avoid permanent disability.
<b>Priority IA—URGENT-SURG</b>	Is assigned to patients that should be evacuated as soon as possible and within a maximum of one hour who must receive far forward surgical intervention to save life, limb, or eyesight and to stabilize for further evacuation.
<b>Priority II—PRIORITY</b>	Is assigned to sick and wounded personnel requiring prompt medical care. This precedence is used when the individual should be evacuated within four hours or if their medical condition could deteriorate to such a degree that they will become an URGENT precedence, or whose requirements for special treatment are not available locally, or who will suffer unnecessary pain or disability.
<b>Priority III—ROUTINE</b>	Is assigned to sick and wounded personnel requiring evacuation but whose condition is not expected to deteriorate significantly. The sick and wounded in this category should be evacuated within 24 hours.
<b>Priority IV—CONVENIENCE</b>	Is assigned to patients for whom evacuation by medical vehicle is a matter of medical convenience rather than a necessity.
The NATO STANAG 3204 has deleted the category of Priority IV—CONVENIENCE, however, this category is still included in the United States Army evacuation priorities as there is a requirement for it in an operational environment.	

This page intentionally left blank.

## Appendix A

# Example of a Mass Casualty Plan

This appendix provides a sample of a MASCAL plan for a brigade sized unit. It should not be considered all-inclusive. It may be supplemented with the information and procedures required for operating within a specific command or special operation, and should be adjusted to include both organic and available vehicles.

Mass Casualty Standard Operations Plan
<p>1. (U) Purpose. This standard operations plan establishes the procedures and responsibilities in the event a MASCAL situation occurs within the brigade combat team area of operations.</p>
<p>2. (U) Scope. This standard operations plan is designed to provide procedures for planning for and reacting to a MASCAL event. The goal of this standard operations plan is to reduce the loss of life and limb by providing clear and concise guidance.</p>
<p>3. (U) Applicability. All assigned and attached personnel.</p>
<p>4. (U) References. ATP 4-02.2. ATP 4-02.13.</p>
<p>5. (U) Definitions. <i><b>Ambulance exchange point</b></i> is a location where a patient is transferred from one ambulance to another en route to a medical treatment facility. Also called AXP.</p> <p><i><b>Casualty</b></i> is any person who is lost to the organization by having been declared dead, duty status — whereabouts unknown, missing, ill, or injured.</p> <p><i><b>Casualty collection point</b></i> is a location that may or may not be staffed, where casualties are assembled for evacuation to a medical treatment facility.</p> <p><i><b>Casualty evacuation</b></i> is the movement of casualties aboard nonmedical vehicles or aircraft without en route medical care. Also called CASEVAC.</p> <p><i><b>Mass casualty</b></i> is any number of human casualties produced across a period of time that exceeds available medical support capabilities. Also called MASCAL.</p> <p><i><b>Medical evacuation</b></i> is the timely and effective movement of the wounded, injured, or ill to and between medical treatment facilities on dedicated and properly marked medical platforms with en route care provided by medical personnel. Also called MEDEVAC.</p> <p><i><b>Triage</b></i> is the process of sorting casualties based on need for treatment, evacuation, and available resources.</p>
<p>6. (U) Concept for a mass casualty situation.</p> <p>a. A MASCAL situation exists when the casualty load exceeds the capability of the medical treatment assets available to the unit.</p>

**Figure A-1. Example of a mass casualty standard operations plan**

b. The scene commander will be the senior nonmedical person (medical personnel will be providing treatment). The scene commander will coordinate the efforts of site security, medical treatment teams, and evacuation teams.

c. Units without organic medical personnel will immediately contact their closest supporting medical unit upon suffering mass casualties.

d. All casualties will be moved to designated CCPs.

e. Available medically trained personnel will assess and triage casualties at the CCP.

f. The forward support company of the brigade support battalion will send designated combat lifesavers and nonstandard evacuation vehicles to assist in the movement of casualties to designated battalion aid stations and MTFs.

g. The brigade support medical company will send designated medical personnel and ambulances to assist.

h. The scene commander will establish a helicopter landing zone for use by air medical evacuation or CASEVAC helicopters.

7. (U) Mass casualty triage.

a. Each unit establishes a triage station to sort casualties for treatment.

b. Medical units will organize and train treatment teams in triage procedures.

- (1) The most senior medical officer is the triage officer.
- (2) A medical officer or physician assistant will head each treatment team of three to four medics.
- (3) The triage officer for the next wave of casualties will be the next most available senior medical officer.

c. Dental and other ancillary medical service officers. Although dental and other ancillary medical service officers (such as a physical therapist) will not normally perform triage, they should still be familiar with its principles. These personnel will provide the following:

- (1) Trauma management.
- (2) Tactical combat casualty care.
- (3) Treatment of MINIMAL category casualties.

d. Triage categories. Casualties are sorted and color coded by marking the casualty’s Department of Defense (DD) Form 1380 (Tactical Combat Casualty Care (TCCC) Card) and Department of the Army (DA) Form 7656 (Tactical Combat Casualty Care (TCCC) Card) as follows:

Priority	Treatment Category	U.S. Color Code	NATO Color Code
1	Immediate	Red	Red
2	Delayed	Yellow	Yellow
3	Minimal	Green	Green
4	Expectant	Black	Blue on White
LEGEND: NATO- North Atlantic Treaty Organization			*Dead-White on Black
The U.S. reservation 7 to NATO STANAG 2228 and Allied Joint Publication 4-10 addresses the variance between NATO’s five triage categories and the U.S. four categories. The NATO fifth color code is for deceased personnel.			

Figure A-1. Example of a mass casualty standard operations plan (continued)

e. Minimally injured patients may be used to assist the treatment teams at the discretion of the treatment or triage officers.

8. Mass casualty medical treatment.

a. The focus of medical treatment at a MASCAL site is the preservation of life, limb, or eyesight (IMMEDIATE and DELAYED categories).

b. Medical treatment personnel will establish a post treatment evacuation holding area, clearly marked by medical evacuation precedence. The recommended method of marking the area is to affix signs to stakes in the ground.

c. If available, the chaplain and combat and operational stress control personnel should be at the holding area.

d. The holding area should allow for the Soldier's leadership to take custody of personal effects that do not accompany the patient through the evacuation process (for example, weapons, night vision devices, and communication equipment).

e. This holding area must be easily accessible to the helicopter landing zone and the ground ambulance route.

9. Mass casualty evacuation procedures.

a. All casualties will be taken to the designated company CCP by designated litter teams. The first sergeant or their representative is responsible for identifying nonmedical Soldiers as members of litter teams.

b. All company combat lifesavers not actively engaged in force protection will go to the company CCP to assist medical teams.

c. The medical noncommissioned officer in absence of a physician or physician assistant will supervise the assessment, triage, and evacuation of casualties at the designated site.

d. The company's first sergeant or their designated representative will be responsible for the transportation of casualties from the company CCP, to the designated MTF, or ambulance exchange point via nonstandard evacuation vehicles.

10. Nonstandard evacuation vehicles.

a. The forward support company commander will create an ordered list of the number of vehicles to be used.

(1) The forward support company supply trucks (for example M1081) will be downloaded with supplies, and designated as evacuation vehicles. These vehicles can be rapidly used to clear the company CCP and facilitate rapid evacuation of litter patients.

(2) A driver and assistant driver are designated.

(3) The vehicles will be prepared, cleaned, and ready for evacuation of patients.

(4) All nonstandard evacuation vehicles will have litters and litter straps present.

(5) An M1093 5-ton or M1081 2 1/2-ton cargo vehicle can transport a total of seven and eight litter patients, respectively.

(6) A cargo HMMWV can transport a total of five litter patients and a four-seat configuration HMMWV can transport three litter patients.

b. Vehicle marking.

**Figure A-1. Example of a mass casualty standard operations plan (continued)**

(1) Whenever the tactical situation allows, nonstandard evacuation vehicles should be marked to indicate that they are carrying casualties.

(2) Day: VS-17/GX marker panel (NSN 8345-00-174-6865) will be placed on the hood or roof of the vehicle, orange side up, to indicate that the vehicle is carrying casualties.

(3) Night: Two infrared chemical lights will be secured to the top corners of the highest point of the front of the vehicle, one for the driver's side and one for the passenger's side.

**Figure A-1. Example of a mass casualty standard operations plan (continued)**

## Appendix B

# Litter Evacuation Training

To safely transport a patient by litter and to ensure litter bearers are not injured by using incorrect lifting procedures, training is required for litter bearers. This appendix provides the techniques and procedures necessary to accomplish litter evacuation.

## PROCEDURES FOR LITTER EVACUATION TRAINING

B-1. Litter bearers are normally grouped into squads of four to carry patients. For this reason, litter procedures for squads of four are effective in training individuals to be litter bearers.

### GUIDELINES FOR TRAINING LITTER BEARERS

B-2. The following guidelines promote uniformity and accuracy in training methods:

- Several squads may be trained at the same time by one individual, or each squad may be instructed separately by an instructor or trained squad leader.
- For the initial training procedures, a litter without a patient on it can be used to simulate a loaded litter.
- For later training, some personnel can be designated as patients or manikins may be used.
- Personnel should be frequently rotated with the ones carrying the litters so that all may participate in each phase of the instruction.
- For more realistic training in the handling of the different types of injuries, patients may wear moulages, bandages, and splints to simulate actual wounds or injuries.
- The persons designated as patients may be positioned on the ground at suitable intervals near a line of litters, first with the head, and later with the feet toward the litters. As the instruction progresses, their positions may be varied. Lastly, they may be dispersed or concealed to simulate positions that the wounded might occupy on a battlefield.

### LITTER COMMANDS

B-3. Litter procedures are not to be considered precision drills; however, certain preparatory commands and commands of execution are used to facilitate instruction. A preparatory command states the movement or formation to be carried out and mentally prepares the individual for its execution. A command of execution tells when the command is to be carried out. For purposes of identification in the discussion of the different types of procedures, preparatory commands will be in lowercase with initial capital letters and commands of execution will be in capital letters.

---

*Note.* The use of formal commands is for training and their use is not anticipated during combat operations.

---

### FORMATION FOR INSTRUCTION

B-4. First, align the trainees into four ranks; then give the commands to form litter squads. This is accomplished as follows:

- The trainees count off from front to rear, one through four, thus forming the litter squads and designating each trainee's position in the litter squad by number. Each number carries with it specific responsibilities in the litter squad. The trainee designated number 1 is the squad leader.

- The squad leaders count off from right to left, designating a number for each litter squad.
- The formation is then opened to provide each squad adequate space for performance.
- Since exceptional circumstances may make it necessary to use two-bearer litter squads, the instruction should include procedures for these reduced squads, using bearers 2 and 3 of the four-bearer squad.

**PROCEDURES TO PROCURE, GROUND, OPEN, CLOSE, AND RETURN THE LITTER**

B-5. The following procedures are prescriptive for demonstrative purposes. Units should modify the procedures as necessary.

**To Procure Litter**

B-6. Upon the command of “Procure, LITTER,” the squad leader (bearer number 1) steps forward, goes to the source of the supply, picks up the litter, and returns to their original position covered by bearers number 2, 3, and 4. The closed litter is carried at high port except near helicopters where it is kept level with the ground to avoid contacting the rotor blades. At high port, the litter is carried diagonally across the body with the left wrist in front of the left shoulder and the right wrist near the right hip (figure B-1).



**Figure B-1. Carrying litter at high port**

B-7. After bearer number 1 returns to their original position in the squad, bearer number 1 holds the litter in an upright position on their left side with the metal stirrups away from their body (figure B-2).





Figure B-2. Litter squad with litter

### To Ground Litter

B-8. Upon command of “Ground, LITTER,” bearer number 1 lowers the litter to the ground. With the litter squad in formation, bearer number 1 places their left foot beside the litter handles, steps forward with their right foot, and lowers the litter to the ground so that it rests on the stirrups (figure B-3).



Figure B-3. Grounding litter (position on ground, litter)

B-9. Upon the command of “Litter, POSTS,” the other three bearers move into their positions at the sides of the litter. Bearer number 2 moves to the right front, bearer number 3 moves to the left rear, and bearer number 4 moves to the left front (figure B-4).



Figure B-4. Grounding litter (position of litter, POSTS)

### To Open Litter

B-10. Upon command of “Open, LITTER,” all bearers face the litter and execute the command. With all bearers facing the litter, bearers number 2 and 3 pick up the litter from the ground and support it, while bearer’s number 1 and 4 unfasten the litter straps (figure B-5).

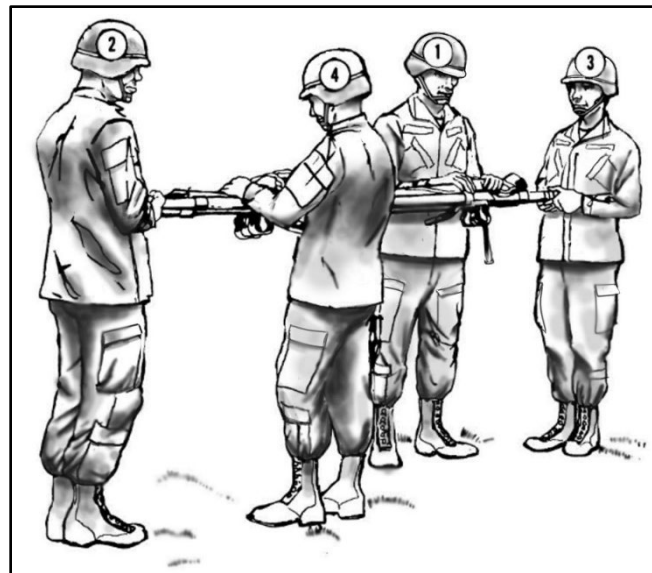
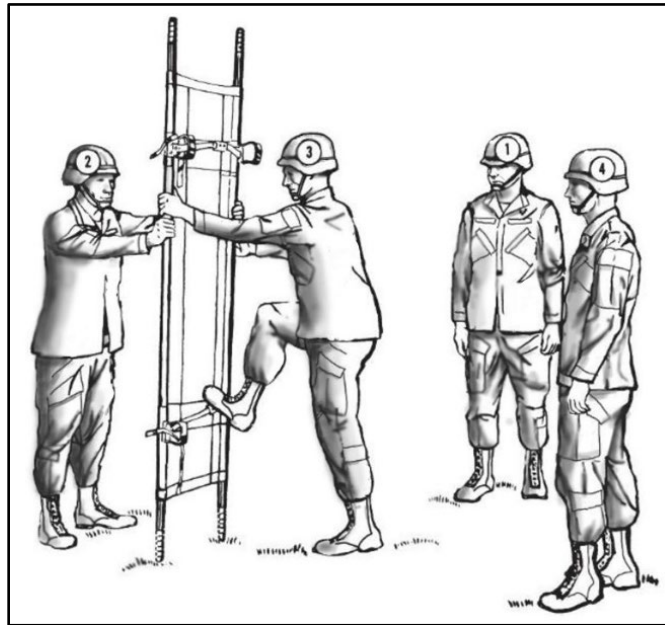

Figure B-5. Opening litter (step one)

B-11. Bearers number 2 and 3 extend the litter by pulling the handles apart with the canvas up. Then bearer number 2 lowers their end of the litter to the ground and bearer number 3 raises their end of the litter until it

is in a vertical position. Using their foot, bearer number 3 extends the lower spreader bar into a locked position, reverses the litter, and extends the other spreader bar. Bearer number 3 then lowers the litter to the ground with the canvas in the up position (figure B-6).



**Figure B-6. Opening litter (step two)**

### To Close Litter

B-12. Upon command of “Close, LITTER,” bearer number 2 supports the litter while bearer number 3 releases the spreader bars and turns the bars against the litter poles. Bearer’s number 2 and 3 then lift the litter, move the poles together, and support the litter. Bearers number 1 and 4 fold the canvas smoothly on top of the poles, and secure the canvas and the poles in place with the litter straps.

### To Return Litter

B-13. At the completion of the instruction and upon command of “Return, LITTER,” bearer number 1 returns the litter to the supply point.

## PROCEDURES FOR LOADING A PATIENT ONTO A LITTER

B-14. After the patient has been located, the general nature of the wounds are determined, emergency treatment is given, the litter is opened and positioned, and the bearers load the patient onto the litter.

### To Load a Litter (Four Bearers)

B-15. Upon the following commands, the bearers position themselves, lift the patient, position the litter, and lower the patient onto the litter:

- At the command “Right (Left) Side, POSTS,” the bearers take the following positions facing the patient: bearer number 2 at the right (left) ankle; bearer number 3 at the right (left) shoulder; bearers number 4 and 1 at the right and left hips, respectively (figure B-7 on page B-6).



**Figure B-7. Squad at right side, POSTS**

- At the command “Prepare to Lift, LIFT,” each bearer kneels on their knee that is nearest the casualty’s feet. Bearer number 2 passes their forearms under the patient’s legs, carefully supporting any fracture, if required. Bearers number 1 and 4 place their arms under the small of the patient’s back and thighs without locking hands. Bearer number 3 passes one hand under the casualty’s neck to the farther armpit and uses the other hand to support the nearer shoulder (figure B-8). All bearers lift the patient slowly and carefully and place the patient upon the knees of the three bearers who are on the same side (figure B-9).

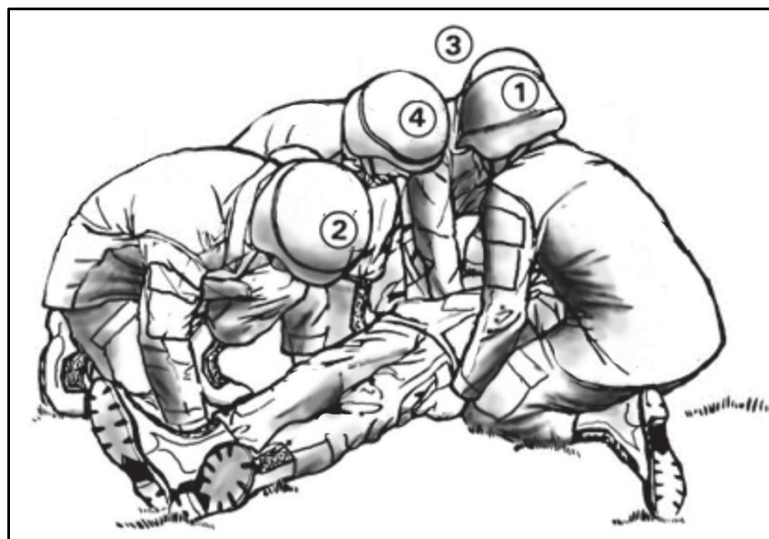

**Figure B-8. Lifting patient to hold litter (step one)**

- At the preparatory command “Prepare to Lower,” bearer number 1 resumes their former kneeling position opposite the other three bearers and prepares to assist in lowering the patient. As soon as the patient is firmly supported on the knees of the three bearers, the bearer on the opposite side (bearer number 1) relinquishes their hold and reaches for the litter (figure B-9). Bearer number 1 places the litter under the patient and against the ankles of the other bearers.

- At the command of execution “LOWER,” the patient is lowered gently onto the litter (figure B-10). Without further orders, all bearers rise and resume their positions at Litter, POST.



**Figure B-9. Lifting patient to load litter (step two)**



**Figure B-10. Lifting patient to load litter (step three)**

### **To Load Litter (Three Bearers)**

B-16. In the absence of one man from the litter squad, bearers number 2 and 3 with the assistance of bearer number 1, lift the patient and lower the patient onto the litter. To lift the patient with three bearers, bearer number 2 places their arms under the legs and thighs of the patient. Bearer number 3 places their arms under the small of the back and shoulders of the patient. Bearer number 1, on the opposite side of the litter, places their arms under the patient's knees and back. The patient is supported on the knees of bearer's number 2 and 3, while bearer number 1 places the litter in position (figure B-11 on page B-8). All three bearers lower

the patient onto the litter (figure B-12). The procedures are performed upon the commands cited in (figure B-8 on page B-6).



Figure B-11. Lowering patient to load litter (three bearers)

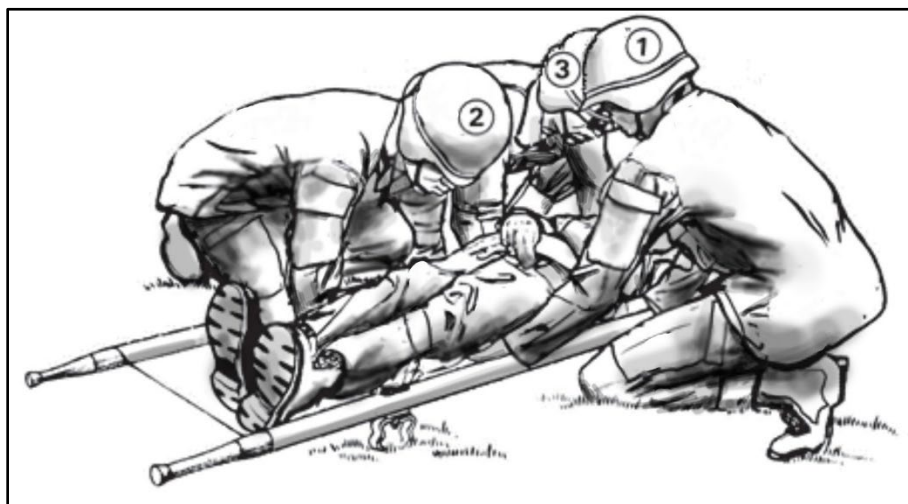
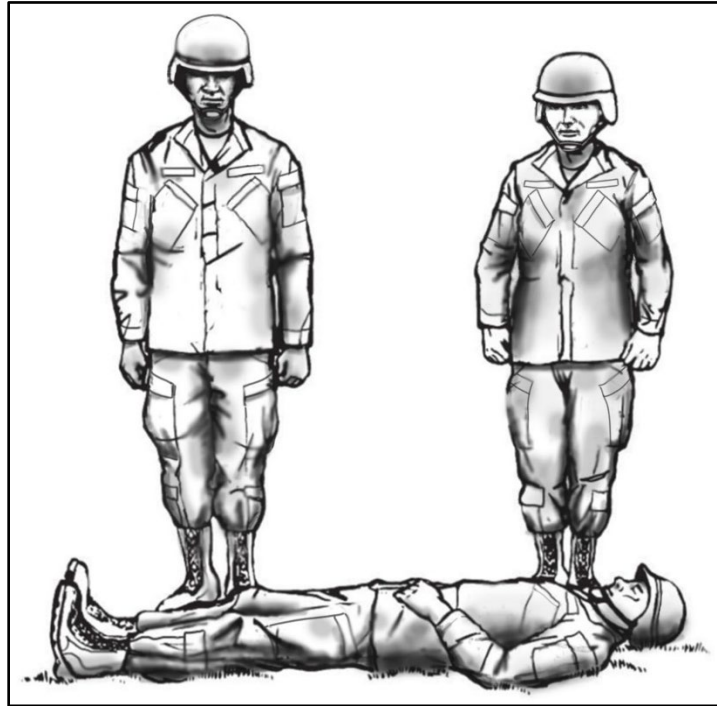

Figure B-12. Lowering patient onto litter (three bearers)

### To Load Litter (Two Bearers)

B-17. The procedures for loading litters with the two bearers on the same side are illustrated in Figures B-13 and B-14, and B-15 and B-16 shown on page B-10 are as follows:

- At the command to “Right Side, POSTS,” bearers number 1 and 2 take positions at the patient’s right thigh and shoulder, respectively (figure B-13).



**Figure B-13. Two bearers at right side, POSTS**

- At the preparatory command “Lift,” each bearer kneels on their knee nearer the patient’s feet. Bearer number 1 passes their arms beneath the patient’s hips and knees. Bearer number 2 passes their arms beneath the small of the patient’s back (figure B-14).

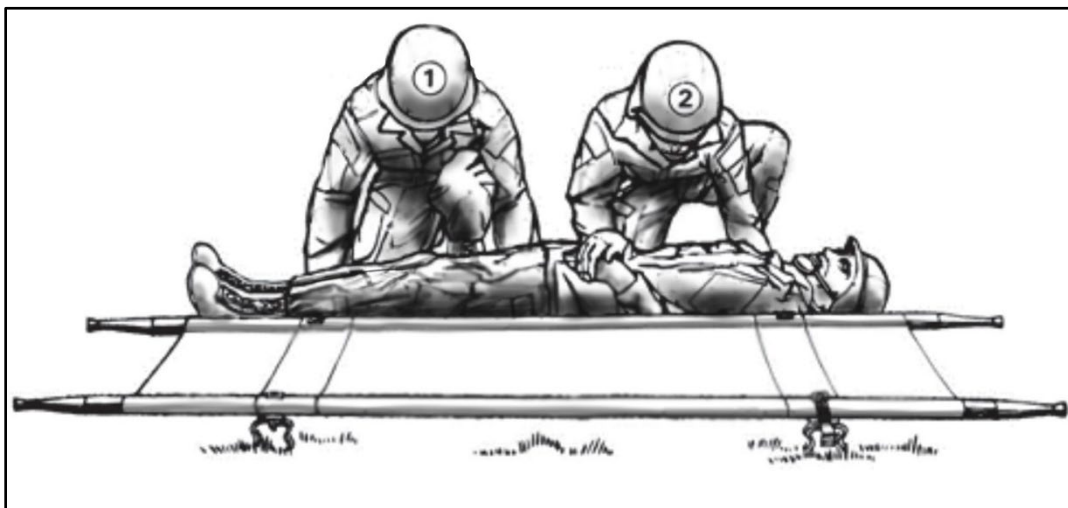

**Figure B-14. Lifting patient with two bearers on the same side**

- At the command of execution “LIFT,” the bearers lift together, raising the patient upon their knees. Readjusting their hold, they rise to their feet and move as close as possible to the side of the litter (figure B-15 on page B-10).

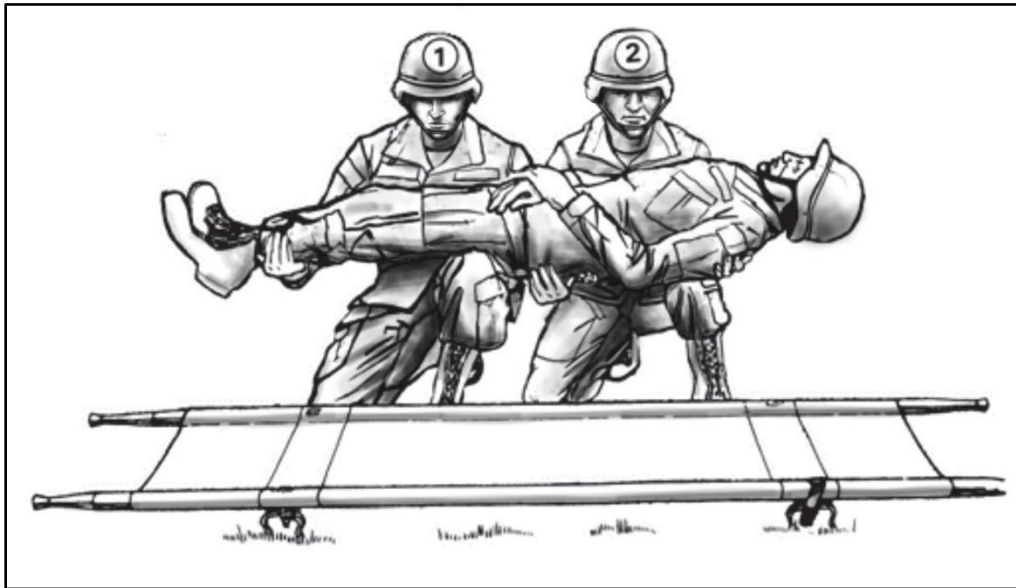

**Figure B-15. Lifting patient with two bearers on the same side (step two)**

- At the preparatory command “Prepare to Lower,” the bearers kneel and place the patient on their knees. At the command of execution “LOWER,” the bearers gently place the patient onto the litter (figure B-16). They then rise and resume the position of Litter, POSTS, without command.

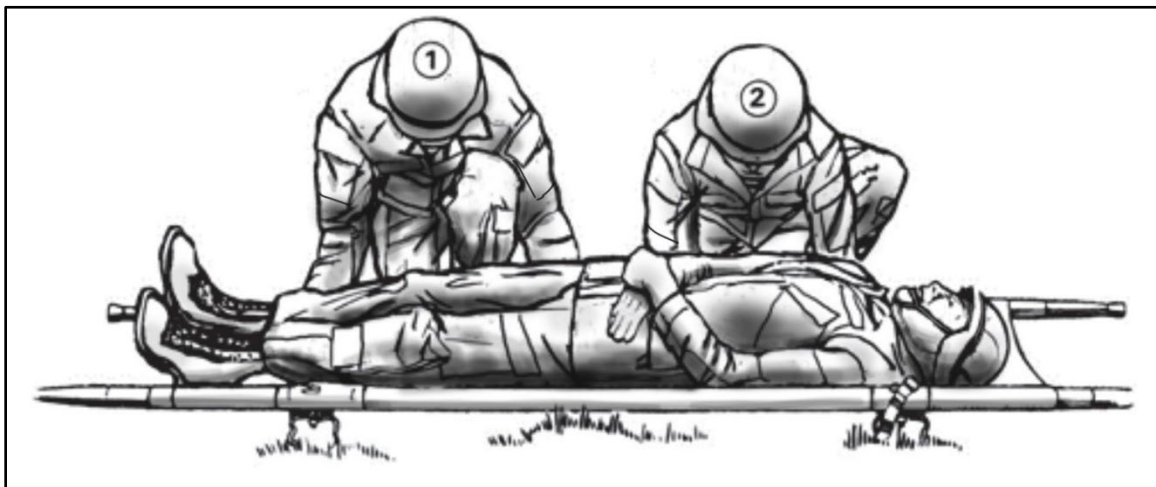

**Figure B-16. Lowering patient onto litter with two bearers on the same side**

### **To Load Litter with Conscious Patient (Two Bearers)**

B-18. If the patient is conscious and able to hold onto the bearers, the following procedure is used:

- At the command “On Each Side, POSTS,” bearers number 1 and 2 face the patient and take positions at the patient’s right and left hips, respectively (figure B-17).





**Figure B-17. Two bearers, one on each side, POSTS**

- At the command of execution “LIFT,” the bearers lift the patient, both rising together, and carry the patient to the center of the litter (figure B-18 below and figure B-19 on page B-12).



**Figure B-18. Lifting patient with two bearers, one on each side (step one)**



**Figure B-19. Lifting patient with two bearers, one on each side (step two)**

- At the command “Prepare to Lower, LOWER,” the bearers stoop and lower the patient onto the litter in a sitting position. The patient then releases their hold on each bearers’ neck. Both bearers assist the patient to lie down. They then resume the position of Litter, POSTS, without commands (figure B-20).

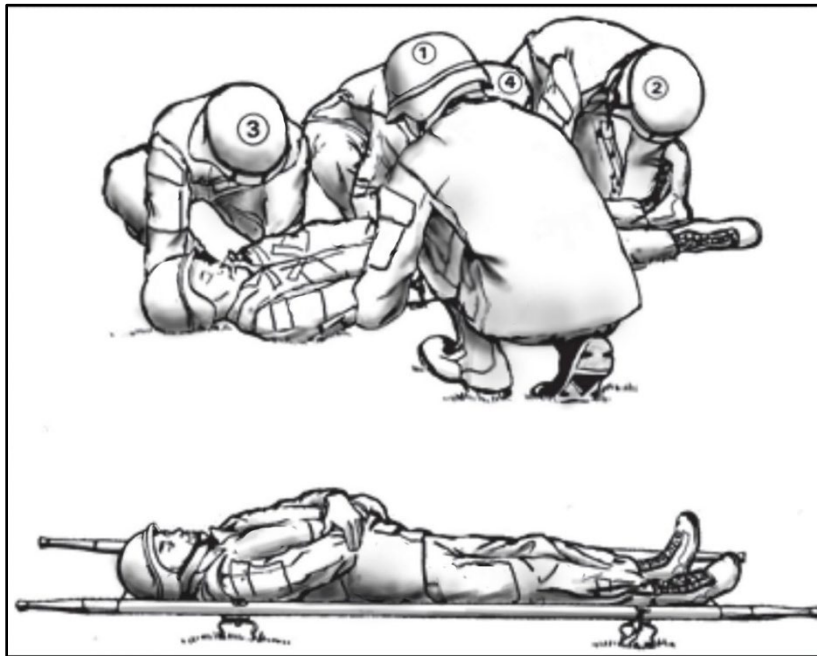

**Figure B-20. Lowering patient onto litter (two bearers, one on each side)**

### To Load Patient with Back Injury

B-19. To avoid aggravating the condition of a patient with an actual or suspected head, neck, or back injury, the casualty should first be placed on a spine board. To place the casualty on a litter the bearers proceed as follows (figure B-21):

- Each bearer kneels on their knee nearer the patient's feet. (If the patient is unable to hold their arms in front of them, their wrists should be tied loosely before placing them on the litter. This will prevent injury to their arms.)
- Bearer number 1 places a blanket, coat, or jacket in a firm roll or in a position to support the arch of the patient's back. Bearer number 3 places one hand under the patient's head and the other hand under their shoulders. Bearer number 4 places their hands under the small of the back and buttocks. Bearer number 2 places their hands under the thighs and calves. Bearer number 1 assists bearer number 4 in supporting the small of the patient's back.



**Figure B-21. Lifting patient with back injury**

- At the command “Prepare to Lift, LIFT,” all bearers gently lift the patient off the ground about 8 inches. Bearers ensure that proper alignment is maintained. Bearer number 1 places the litter under the patient and adjusts the roll under the patient's back.
- At the command “Prepare to Lower, LOWER,” the three bearers lean forward and with the aid of bearer number 1, lower the patient onto the litter.

### PROCEDURES FOR CARRYING A LOAD LITTER

B-20. After the patient has been loaded onto the litter, the litter is lifted and carried as described below.

#### To Lift Loaded Litter

B-21. Upon the command of “Litter, POSTS,” the bearers resume their position facing in the direction of travel and lift the loaded litter upon the command “Prepare to Lift, LIFT” (figure B-22 on page B-14). At the preparatory command “Prepare to Lift,” each bearer kneels on their knee closest to the litter. Bearers grasp the litter handle with the hand nearest the litter and places their other hand on their raised knee. At the command of execution “LIFT,” all bearers rise together keeping the litter level. When lifting, bearers should use leg muscles, not their back muscles.

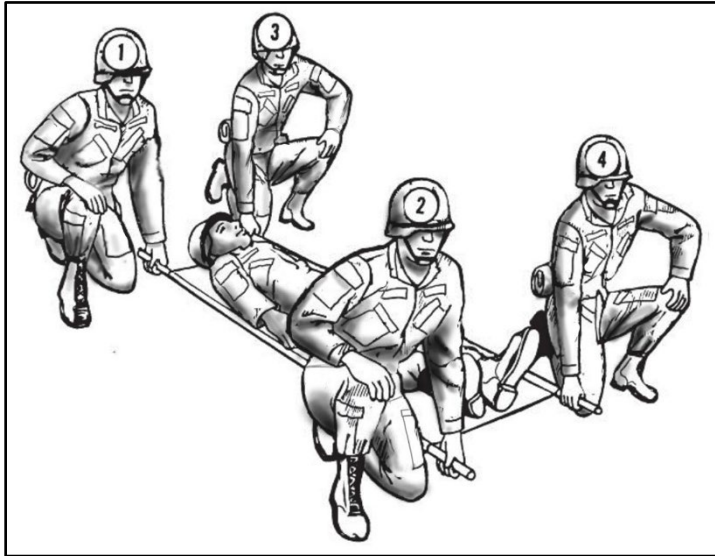

Figure B-22. Lifting the loaded litter

### To Carry a Loaded Litter

B-22. The type of carry used in transporting a litter patient depends upon the type of terrain as well as the obstacles involved. It may be necessary to use several types of carries.

#### *Four-Man Carry*

B-23. After the bearers lift the loaded litter, they are in position for the four-man carry (figure B-23) which is used when the terrain is smooth and level. The command to proceed is “Four-Man Carry, MOVE.” With modifications, this carry is also used to pass under low obstacles.

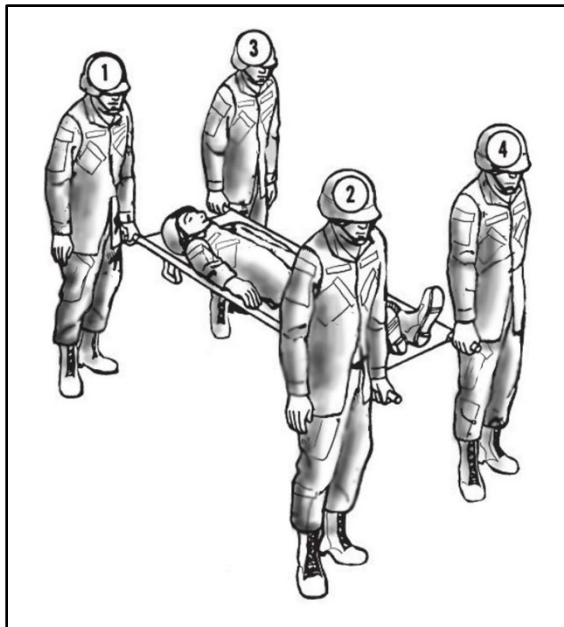
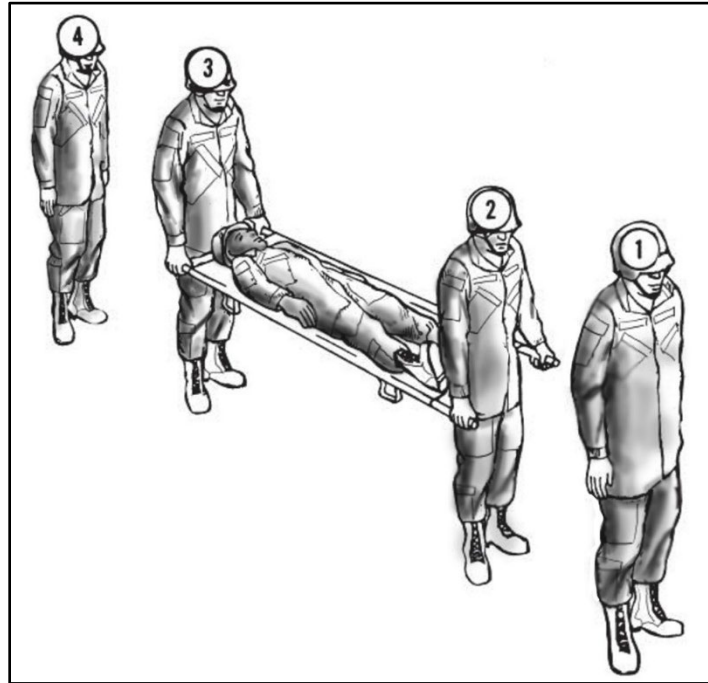

Figure B-23. Four-man carry for smooth, level terrain

**Two-Man Carry**

B-24. The command “Two-Man Carry, MOVE” is given to enable the litter squad in a four-man carry to pass through or over narrow passages such as trails, bridges, gangplanks, and catwalks (figure B-24). After the litter bearers reach the end of such passages, they change back to the four-man carry. With modification, this carry can also be used to pass through such obstacles as culverts or tunnels. Both bearers carrying the litter face the patient and crawl on their knees through these obstacles. This requires one bearer to crawl backwards. To use this technique perform the following:



**Figure B-24. Two-man carry for smooth, level terrain**

- With the litter squad in the position of the four-man carry, the preparatory command “Two-man Carry” is given. Bearers number 2 and 3 change their holds on the litter handles to the other hand, step between the handles, and take the full support of the litter as bearers number 1 and 4 release their holds.
- Bearer number 1 steps one pace in front of the squad to lead, and bearer number 4 falls one pace to the rear to follow.
- At the command of execution “MOVE,” the four bearers proceed through the passage.

**Litter Post Carry**

B-25. The command “Litter Post Carry, MOVE” is given to enable the litter squad in a four-man carry to move over rough terrain (figure B-25 on page B-16). Perform the following to execute the litter post carry:

- With the litter squad in position of the four-man carry, the preparatory command “Litter Post Carry” is given. Bearers number 2 and 3 step between the handles of the litter and take hold of the handles. Bearers number 1 and 4 then release their holds.
- Bearers number 1 and 4 move to the sides of the litter and grasp the litter poles.
- At the command of execution “MOVE,” and the four bearers proceed carefully over the rough terrain.

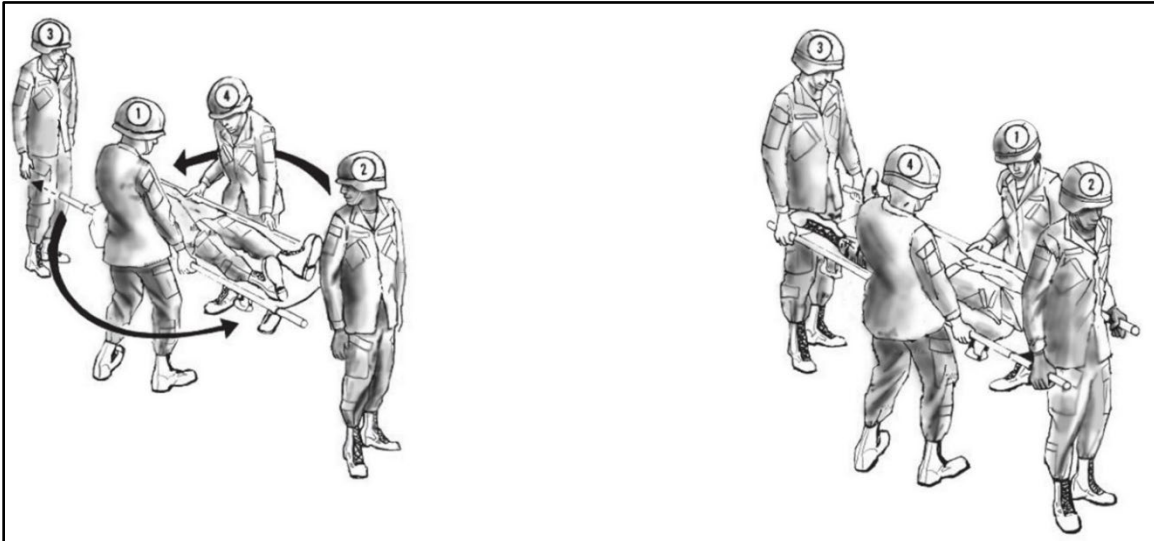

**Figure B-25. Litter post carry for rough terrain**

### *Uphill Carry*

B-26. Except when the patient has a fracture of a lower extremity, the litter is carried uphill or upstairs with the patient's head forward. Therefore, before proceeding with the uphill carry, the litter must first be turned correctly. From the position of four-man carry (figure B-23 on page B-14), the litter squad first moves into the position of litter post carry (figure B-25); then the command "Prepare to Rotate, ROTATE" (figure B-26) is given and followed by command "Uphill (Upstairs) Carry, MOVE" (figure B-27). Perform the following to execute the uphill carry:

- With the litter squad in the position of litter post carry, the preparatory command "Prepare to Rotate" is given. Bearers number 2 and 3 release the litter handles and step one pace away, allowing bearers number 1 and 4 to support the litter at its sides.
- At the command of execution "ROTATE," bearer's number 1 and 4 move 180 degrees counterclockwise, thus placing the patient's head in the direction of travel with bearer number 1 still on the patient's right side.
- As soon as bearers number 2 and 3 observe that the rotation has been completed, they resume their positions at the litter handles. The rotation of the litter places bearer number 2 at the patient's head.
- After the litter is rotated so that the patient's head is in the direction of travel, the squad halts.
- At the preparatory command "Uphill (Upstairs) Carry," bearer number 4 moves to the foot of the litter and takes hold of the litter handle released by bearer number 3. Bearer number 1 moves in front of the squad.
- At the command of execution "MOVE," the squad proceeds uphill (upstairs) with bearer number 1 preceding the squad. Bearers number 3 and 4 keep the litter level.



**Figure B-26. Rotation of the litter for uphill and upstairs carry and for ambulance loading**

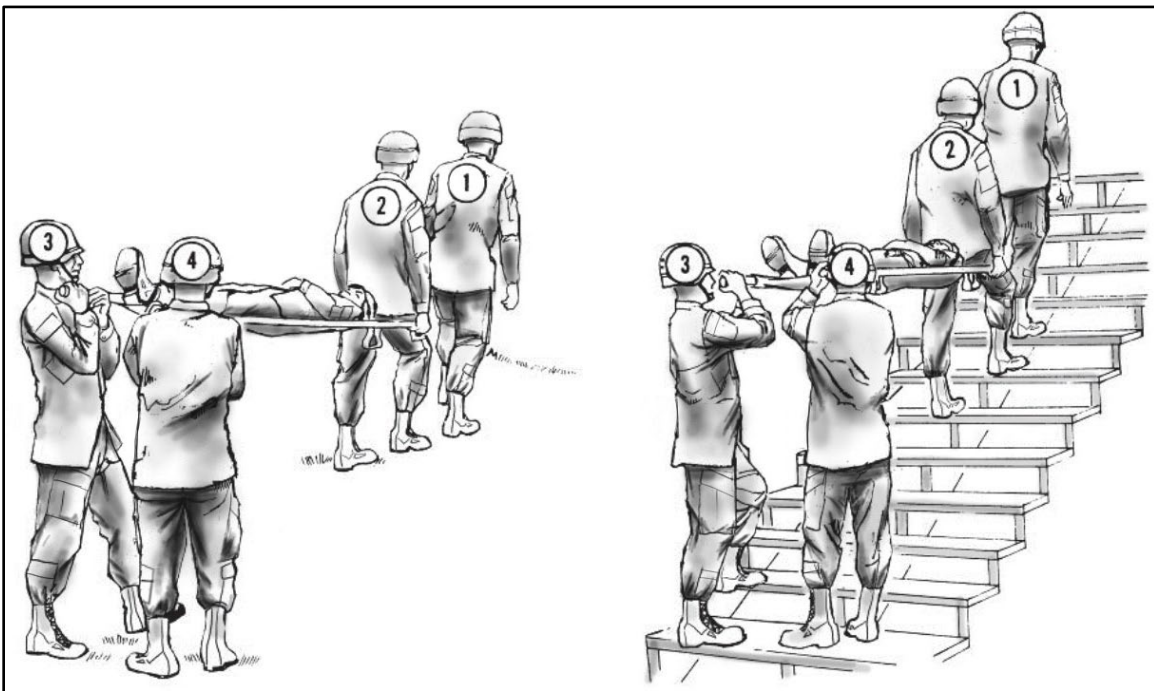

**Figure B-27. Uphill and upstairs carry**

### ***Downhill Carry***

B-27. Except when the patient has a fracture of a lower extremity, the litter should be carried downhill or downstairs with the patient's feet forward. The command "Downhill (Downstairs) Carry, MOVE" (figure B-28 on page B-18) is given when the litter squad is in the position of four-man carry (Figure B-23 on page B-14) or in the position of litter post carry (figure B-25 on page B-16) provided it has been used to rotate the loaded litter or to move it over rough terrain just prior to carrying it downhill (downstairs). Perform the following to execute the downhill carry:

- With the litter squad in the position of the four-man carry, the preparatory command “Downhill (Downstairs) Carry,” is given. Bearer number 3 takes the full support of the litter at the patient’s head, and bearer’s number 2 and 4 remain in their positions at the patient’s feet.
- Bearer number 1 moves to the front, facing the squad. Bearer number 1 supports bearers number 2 and 4 and ensures that they keep the litter level as they move downhill (downstairs).
- Before lowering the litter to the ground, the bearers resume the position of four-man carry. At the preparatory command “Lower, Litter,” each bearer slowly kneels on the knee closest to the litter and gently places the litter on the ground. The squad then stands without command. For balance and support when lowering the litter, each bearer places their free hand on their other knee which remains in an upright position.

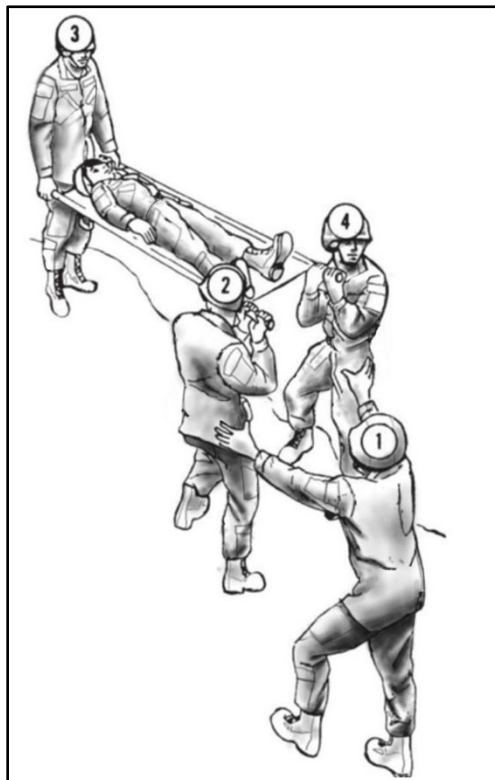

Figure B-28. Downhill or downstairs carry

## PROCEDURES FOR SURMOUNTING OBSTACLES

B-28. In litter transportation, bearers must be able to surmount various artificial and natural obstacles such as fences, high walls, deep trenches, wide streams, and stairwells with small landings. Specific commands for surmounting these obstacles are neither necessary nor feasible, as they must be given in conjunction with the commands for the appropriate litter carry. Common sense must also be used in adapting specific procedures to individual situations.

### Litter Obstacle Course

B-29. A litter obstacle course is a useful training tool for surmounting obstacles and for the physical conditioning of bearers. An obstacle course can be constructed to simulate most types of natural and artificial obstructions that litter bearers are likely to meet. Where construction of such a course is impracticable, many obstacles can be simulated from existing facilities.



## Methods and Modifications

B-30. A number of methods, as well as modifications in litter carries, which enable the litter squad to surmount various obstacles, are discussed below. Litter teams should consider the obstacle and size of the litter team in order to select the most effective method.

### *Surmounting a Fence or Low Wall*

B-31. With the litter squad in the position of “Litter Post, Carry,” bearer number 2 releases their grasp of the front handles at the patient’s feet and crosses the obstacle, maintaining a low silhouette. Bearers number 1, 3, and 4 then advance the litter until bearer number 2 can resume their grip of the front handles (figure B-29).

B-32. The litter is rested on the obstacle with the stirrups placed on the side of the obstacles in the direction of travel. Bearers number 2 and 3 support the litter by the front and rear handles, respectively, while bearers number 1 and 4 cross the obstacle maintaining a low silhouette. Having passed the obstacle, bearers number 1 and 4 grasp the litter poles near the rear handles held by bearer number 3. Bearer number 3 then releases their hold of the rear handles and crosses the obstacle, maintaining a low silhouette. Bearer number 3 resumes their grasp on the rear handles and bearers number 1 and 4 adjust the position of their holds as depicted in (figure B-30 on page B-20).

---

*Note.* The litter should be lifted and not dragged across the top of the obstacle.

---

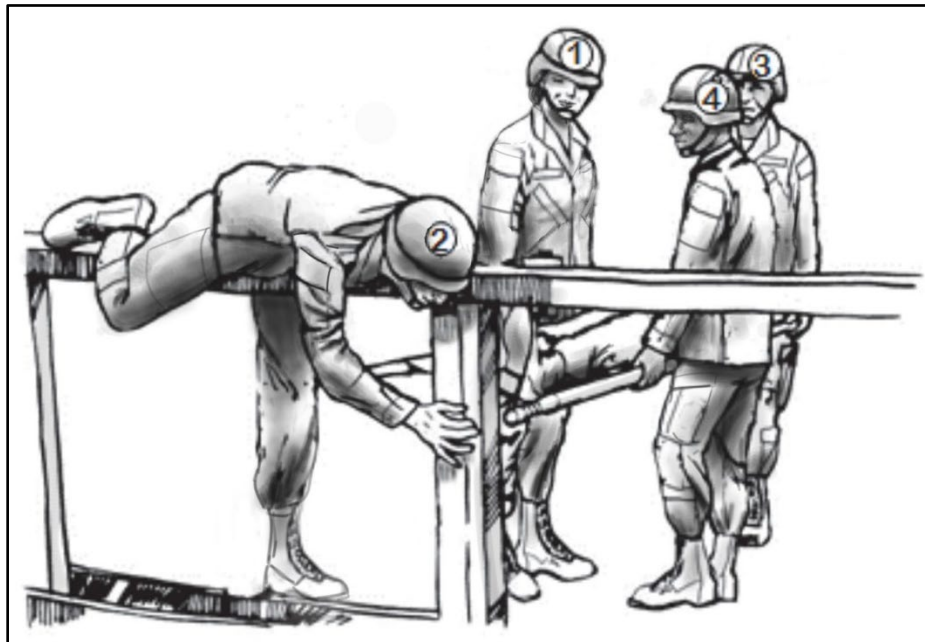

**Figure B-29. Surmounting a fence or low wall (step one)**

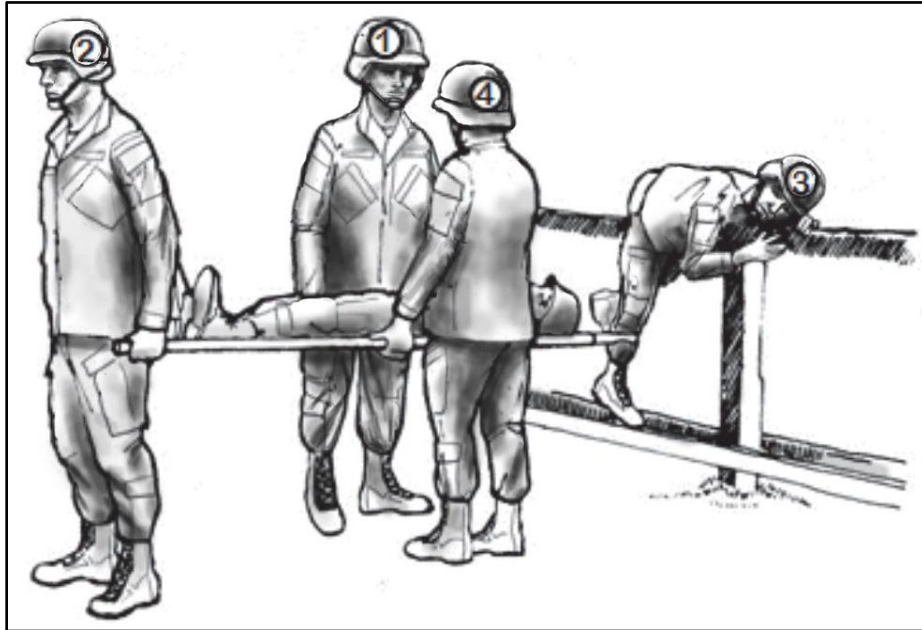

Figure B-30. Surmounting a fence or low wall (step two)

*Surmounting a High Wall*

B-33. With the litter squad in the position of the four-man carry, the bearers turn and face each other. Together they raise the litter approximately chest high, step close to the litter, letting their bent elbows touch their chests. The front bearers place the front stirrups beyond the wall, scale the wall, and drop to the other side. All four bearers move the litter forward until the rear stirrups are against the wall, taking care to avoid scraping the patient's back. The rear bearers then scale the wall, drop to the other side, and lift their end of the litter off the wall (figure B-31). The bearers then resume the four-man carry.

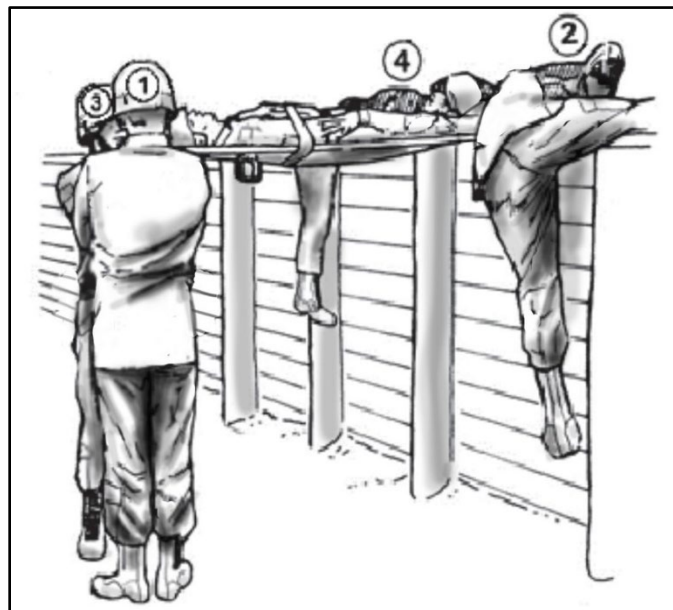

Figure B-31. Surmounting a high wall

***Fording Streams and Crossing Deep Trenches***

B-34. With the litter squad in position for the four-man carry, the bearers turn and face each other, determining who is the taller of the two at each end of the litter. Together they raise the litter over their heads, keeping it level. If they are in a trench, they lift the litter above the top of the trench (figure B-32).

B-35. The taller bearer at each end of the litter moves between the handles, facing in the direction of travel and grasps the handles as close to the canvas as possible. The shorter bearer at each end moves under the litter, facing in the direction of travel and grasps the stirrups, which compensate for the differences in height. If all bearers are of equal height, the bearers under the litter grasp the litter poles to the side of the stirrups nearer the ends (figure B-33 on page B-22).



**Figure B-32. Fording streams and crossing deep trenches  
(overhead carry, step one)**

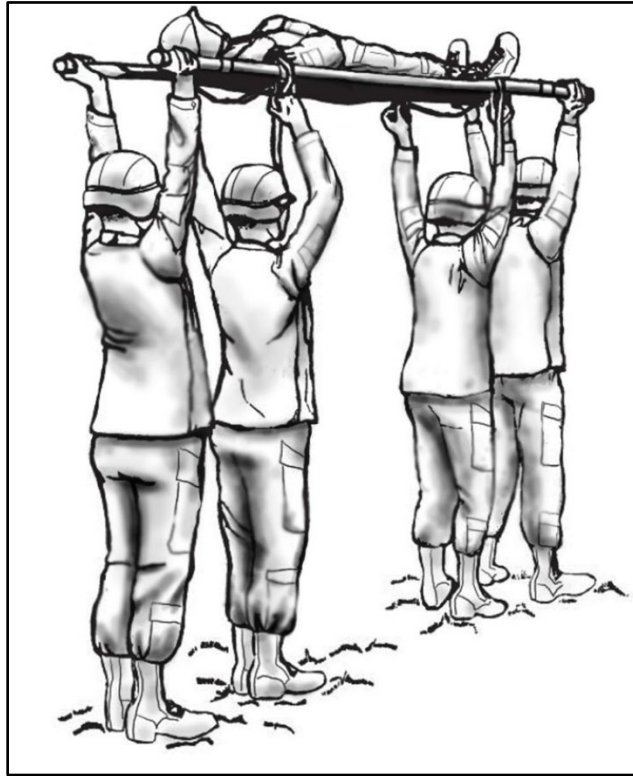

**Figure B-33. Fording streams and crossing deep trenches (overhead carry, step two)**

---

*Note.* If the front bearer steps into a hole while crossing a stream and releases their hold, the other three bearers could keep the litter in this position.

---

### *Carrying a Litter Patient Up a Stairwell with Small Landings*

B-36. The steps for this procedure (figure B-34) are as follows:

- The litter squad proceeds upstairs to the landing with bearer's number 1 and 3 supporting the head of the litter and bearers number 2 and 4 supporting the foot of the litter. (Step A).
- Upon arrival at the landing, bearer number 3 turns facing the head of the litter and supports it while bearer number 1 proceeds several steps up the next flight of stairs. Bearers number 2 and 4 raise the foot of the litter until bearer number 1 can grasp the handle released by bearer number 2. Bearer number 2 then moves to the side of the litter. (Step B).
- With bearer number 2 helping bearer number 1 to support the litter, bearer number 1 grasps the handle released by bearer number 4. (Step C).
- Bearer number 4 continues to help support the litter on the side as it moves up the stairs. (Step D).
- Bearer number 4 assists bearer number 3 in carrying the head of the litter while bearer number 2 advances and assists bearer number 1 in carrying the foot of the litter to the next landing. (Step E).

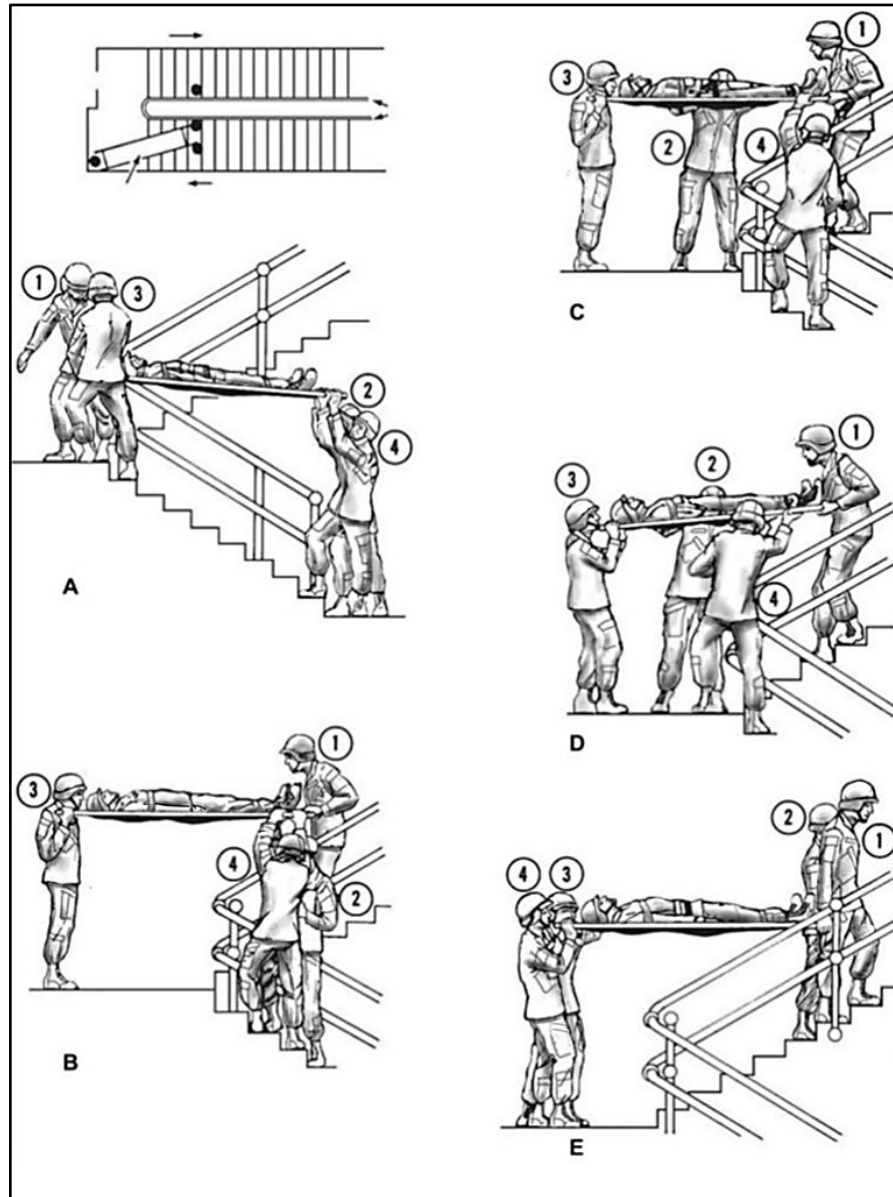

**Figure B-34. Carrying a litter patient up a stairwell with small landings**

***Carrying a Litter Patient down a Stairwell with a Small Landing***

B-37. The steps for this procedure (figure B-35 on page B-24) are as follows:

- The litter squad proceeds down the steps to the first landing with bearers number 1 and 3 supporting the head of the litter and bearer's number 2 and 4 supporting the foot of the litter. (Step A).
- Upon arrival at the first landing, bearer number 4 turns and faces toward the litter and supports the foot of the litter while bearer number 3 supports the head of the litter. Bearers number 1 and 2 descend a few steps to the lower flight of stairs and receives the head of the litter from bearer number 3. (Step B).
- Bearer number 3 moves to the foot of the litter to assist bearer number 4 while bearers number 1 and 2 support the head of the litter. They then move down the stairs to the next landing. (Step C).

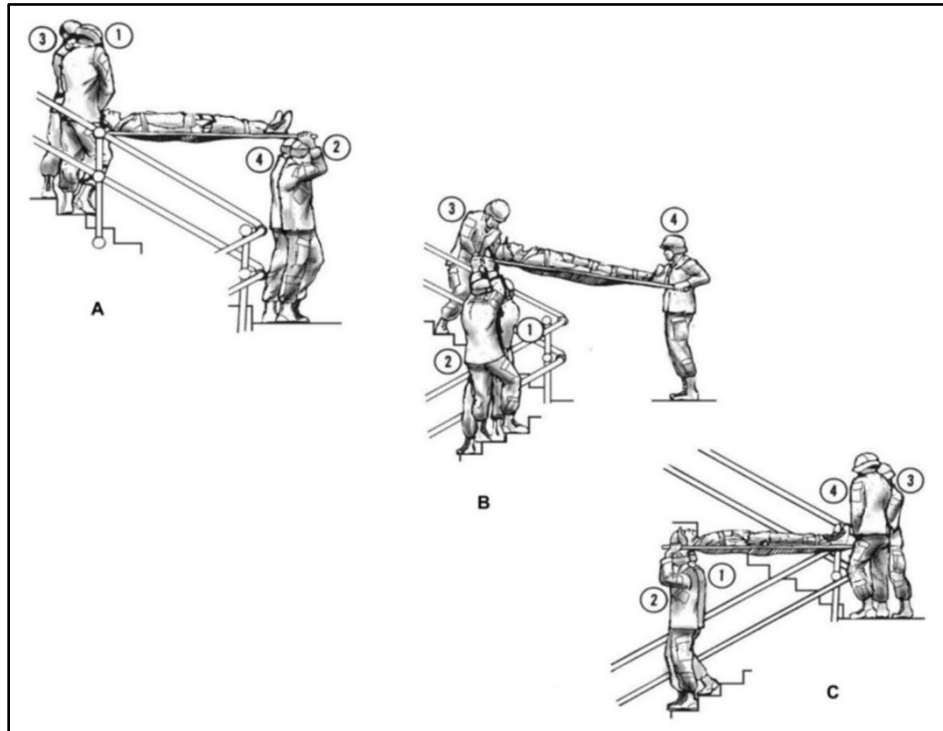

Figure B-35. Carrying a litter patient down a stairwell with small landings

## Appendix C

# 9-Line Medical Evacuation Request

Procedures for requesting medical evacuation must be institutionalized down to the unit level. Procedural guidance and standardization of request procedures are provided below. The same format is used to request both ground and aeromedical evacuation. The 9-line medical evacuation request should always be transmitted by secure means. Refer to ATP 4-02.2 for more information on MEDEVAC.

**Table C-1. 9-line medical evacuation request**

<i>Line</i>	<i>Item</i>	<i>Explanation</i>	<i>Where/how obtained</i>	<i>Who normally provides</i>	<i>Reason</i>
1	Location of pickup site.	Grid coordinates of the pickup site should be sent by secure communication. To prevent confusion the grid zone letters are included in the message.	From map or navigational device determine the military grid reference system six-digit grid coordinates of the pickup site.	Unit leader(s).	Required so evacuation vehicle knows where to pick up the patient/casualty. Also, so that the unit coordinating the evacuation mission can plan the route for the evacuation vehicle (if the evacuation vehicle must pick up from more than one location).
2	Radio frequency, call sign and suffix.	Frequency of the radio at the pickup site, not a relay frequency. The call sign (and suffix if used) of person to be contacted at the pickup site may be transmitted in the clear.	From automated net control device or other approved means.	Radio transmission operator.	Required so that evacuation vehicle can contact requesting unit while en route (obtain additional information or changes in situation or directions).
3	Number of patients by precedence.	A—URGENT B—URGENT-SURG C—PRIORITY D—ROUTINE E—CONVENIENCE If two or more categories must be reported in the same request, insert the word "BREAK" between each category.	From evaluation of patients.	Medic or senior person present.	Required by unit controlling vehicles to assist in prioritizing missions.

Table C-1. 9-line medical evacuation request (continued)

<i>Line</i>	<i>Item</i>	<i>Explanation</i>	<i>Where/how obtained</i>	<i>Who normally provides</i>	<i>Reason</i>
4	Special equipment required.	A—None B—Hoist C—Extraction equipment D—Ventilator	From evaluation of patient/situation.	Medic or senior person present.	Required so that the equipment can be placed on board the evacuation vehicle prior to the start of the mission.
5	Number of patients by type.	Report only applicable information, if requesting medical evacuation for both types, insert the word "BREAK" between the litter entry and ambulatory entry. L+# of patients—Litter A+# of patients—Ambulatory (sitting)	From evaluation of patients.	Medic or senior person present.	Required so that the appropriate number of evacuation vehicles may be dispatched to the pickup site. They should be configured to carry the patients requiring evacuation.
6	Security of pickup site (wartime).	N—No enemy troops in area. P—Possibly enemy troops in area (approach with caution). E—Enemy troops in area (approach with caution). X—Enemy troops in area (armed escort required).	From evaluation of situation.	Unit leader.	Required to assist the evacuation crew in assessing the situation and determining if assistance is required. More definitive guidance can be furnished to the evacuation vehicle while it is en route (specific location of enemy to assist an aircraft in planning its approach).
6	Number and type of wound, injury or illness (peacetime).	Specific information regarding patient wounds by type (gunshot or shrapnel). Report serious bleeding, along with patient's blood type, if known.	From evaluation of patients.	Medic or senior person present.	Required to assist evacuation personnel in determining treatment and special equipment needed.
7	Method of marking pickup site.	A—Panels B—Pyrotechnic signal C—Smoke signal D—None E—Other	Based on situation and availability of materials.	Medic or senior person present.	Required to assist the evacuation crew in identifying the specific location of the pickup. Note that the color of the panel or smoke should not be transmitted until the evacuation vehicle contacts the unit (just prior to its arrival). For security, the crew should identify the color and the unit verifies it.



Table C-1. 9-line medical evacuation request (continued)

<i>Line</i>	<i>Item</i>	<i>Explanation</i>	<i>Where/how obtained</i>	<i>Who normally provides</i>	<i>Reason</i>
8	Patient nationality and status.	The number of patients in each category need not be transmitted. A—U.S. military B—U.S. citizen C—Non-U.S. military D—Non-U.S. citizen E—Enemy prisoner of war	From evacuation platform.	Medic or senior person present.	Required to assist in planning for destination facilities and need for guards. Unit requesting support should ensure that there is an English-speaking representative at the pickup site.
9	Chemical, Biological, Radiological, and Nuclear contamination (wartime).	Include this line only when applicable. C—Chemical B—Biological R—Radiological N—Nuclear	From situation.	Medic or senior person present.	Required to assist in planning for the mission. (Determine which evacuation vehicle will accomplish the mission and when it will be accomplished.)
9	Terrain description (peacetime).	Includes details of terrain features in and around proposed landing site. If possible, describe relationship of site to prominent terrain feature (lake, mountain, or tower).	From area survey.	Personnel present.	Required to allow evacuation personnel to assess route/avenue of approach into area. Of particular importance if hoist operation is required.

C-1. United States Soldiers regularly operate as part of a NATO allied joint task force. During these operations, Soldiers may receive or transmit 9-line MEDEVAC requests to and from NATO allies. Soldiers must understand the differences between the NATO and U.S. MEDEVAC request formats to avoid confusion. The NATO medical evacuation request format differs from the U.S. format in several ways—

- The Urgent Surgical category is not used by NATO. The United States uses the Urgent Surgical category to ensure a patient requiring surgery could be evacuated directly to the closest surgical asset and enables roll bypass when the closest MTF (such as a Role 2) does not have that capability whereas another further away (such as a Role 2 with a forward surgical detachment or a Role 3) would.
- The NATO line 6 only requires security at pick-up site and does not have two separate information criteria that the U.S. 9-line MEDEVAC request contains, one for wartime (security at pick-up site) and one for peacetime (number and type of wound, injury, or illness).
- The NATO line 8 has similar but different patient nationality status codes and definitions. The primary distinction is the United States specifies “U.S. military” or “U.S. civilian” whereas NATO uses simply “military” or “civilian.” This can cause confusion if patient regulating policies require specific facilities for civilians or specific nationalities.

C-2. Some multinational partners may request additional information in conjunction with a 9-line MEDEVAC request. The additional information may be included incorporating the mechanism of injury, injury type, signs, treatment (also known as MIST) report into the 9-line MEDEVAC request. For further information, refer to ATP 4-02.2 and AJMeDP-2, Allied Joint Medical Doctrine for Medical Evacuation.

This page intentionally left blank.

## Appendix D

# Casualty Evacuation Checklist

A checklist is used as a planning tool to help organize and account for requirements and actions. Checklists for CASEVAC planning and operations share many similarities. However, mission variables will require modifications to ensure key aspects are not overlooked that could impede or prevent successful CASEVAC. While Army watercraft and other vehicles may be used as a CASEVAC platform, the checklist below addresses ground and air CASEVAC vehicles because they are more readily available. A unit CASEVAC checklist should be modified as needed for their organization.

**Table D-1. Casualty evacuation checklist**

<b>Aid/Litter Team/Casualty Evacuation (CASEVAC) Crew Preparation and Planning</b>	
How many personnel are available for aid/litter teams and CASEVAC crews?	
Are additional medical personnel or combat lifesaver available?	
Has unit medical personnel provided training to CASEVAC crews on evacuation tactics, techniques, and procedures (TTPs)?	
Do CASEVAC crews understand the triage categories and marking at casualty collection point (CCP)/medical treatment facility (MTF) (night and day)?	
Do CASEVAC crews understand patient flow in CCPs and the MTF?	
Has CASEVAC equipment (litters, litter straps, etc.) been obtained and inspected?	
Have aid and litter teams been identified and trained?	
Have CASEVAC crews trained and rehearsed manual carries and litter techniques?	
Is additional or special CASEVAC equipment needed?	
Is additional training necessary for special CASEVAC equipment or techniques?	
Are drivers licensed for their CASEVAC vehicle? Is the TC?	
What are the evacuation request procedures?	
What is the evacuation frequency/call-sign (ground and air)?	
How are CASEVAC crews notified when they are needed?	
Are CASEVAC personnel trained on evacuation categories?	
What is the estimated time needed to evacuate a casualty from the CCP to the MTF/ambulance exchange point (AXP)/landing zone (LZ)?	
What is the rest cycle for CASEVAC crews when in extreme climates or wearing chemical protective clothing?	
How do the CASEVAC crews support medical personnel in a mass casualty (MASCAL) situation?	
When and where are CASEVAC crews expected to return to their organizations?	
How do you request Class VIII resupply?	
Has the unit rehearsed the CASEVAC plan?	
Does the CASEVAC plan support the medical evacuation plan?	

**Table D-1. Casualty evacuation checklist (continued)**

<b>Ground CASEVAC Platform</b>	
What levels of ground CASEVAC support are available (dedicated/designated/platform of opportunity)?	
What is the number and type of designated or dedicated CASEVAC ground vehicles?	
How are CASEVAC vehicles marked?	
What is the total ground CASEVAC lift capacity (litter and ambulatory) by type?	
Were CASEVAC crews trained on vehicle specific TTPs for its use as a CASEVAC platform?	
Which CASEVAC vehicles are equipped with radios and where are they positioned in the convoy?	
Are vehicles providing security during movement along evacuation routes?	
Does the CASEVAC vehicle have a mounted crew served weapon?	
What is the status (road conditions, enemy threat) on the evacuation routes?	
Where will ground CASEVAC crews and vehicles be located?	
Are the primary, secondary, and contaminated evacuation routes known, plotted on maps, and has a reconnaissance been conducted?	
Have ground CASEVAC crews rehearsed movement along evacuation routes?	
Have the CASEVAC crews rehearsed TTPs if enemy contact occurs during evacuation?	
<b>Air CASEVAC Platform</b>	
What levels of air CASEVAC support are available (dedicated/designated/platform of opportunity)?	
What is the number and type of designated or dedicated CASEVAC aircraft?	
Have CASEVAC crews been given an aircraft orientation briefing on operating around, loading, and unloading the supporting aircraft including signals and TTPs?	
What is the total air CASEVAC lift capacity (litter and ambulatory) by type?	
Are CASEVAC aircraft equipped and in carrying configuration?	
Who is the launch authority for CASEVAC aircraft?	
Is the location of helicopter LZs plotted on maps and known to the CASEVAC crews?	

# Glossary

## SECTION I – ACRONYMS AND ABBREVIATIONS

<b>ATP</b>	Army techniques publication
<b>ATGM</b>	antitank guided missile
<b>AXP</b>	ambulance exchange point
<b>BAS</b>	battalion aid station
<b>C</b>	Celsius
<b>CASEVAC</b>	casualty evacuation
<b>CAT</b>	category
<b>CCP</b>	casualty collection point
<b>CROWS</b>	common remotely operated weapons system
<b>CSV</b>	combat support vehicle
<b>CTV</b>	combat tacticle vehicle
<b>CV</b>	commander's vehicle
<b>DA</b>	Department of the Army
<b>DD</b>	Department of Defense
<b>ESV</b>	engineer squad vehicle
<b>F</b>	Fahrenheit
<b>FM</b>	field manual
<b>FSV</b>	fire support vehicle
<b>GP</b>	general purpose
<b>HEMTT</b>	heavy expanded, mobility tactical truck
<b>HMMWV</b>	high-mobility multipurpose wheeled vehicled
<b>ICV</b>	infantry carrier vehicle
<b>ICV-J</b>	infantry carrier vehicle Javelin
<b>JLTV</b>	joint light tacticle vehicle
<b>JP</b>	joint publication
<b>LCM</b>	landing craft, mechanized
<b>LCU</b>	landing craft, utility
<b>LMTV</b>	light medium tacticle vehicle
<b>LSV</b>	logistics support vessel
<b>LT</b>	large tug
<b>LUH</b>	light utility helicopter
<b>LZ</b>	landing zone
<b>MASCAL</b>	mass casualty
<b>MEDEVAC</b>	medical evacuation
<b>MGS</b>	mobile gun system

<b>MRAP</b>	mine-resistant ambush protected
<b>MTF</b>	medical treatment facility
<b>MTV</b>	medium tactical facility
<b>NATO</b>	North Atlantic Treaty Organization
<b>NBCRV</b>	Nuclear, Biological, Chemical Reconnaissance vehicle
<b>ORP</b>	objective rally point
<b>POI</b>	point of injury
<b>RV</b>	reconnaissance or scout vehicle
<b>SOP</b>	standard operating procedure
<b>ST</b>	small tug
<b>STANAG</b>	Standardization Agreement
<b>TB</b>	technical bulletin
<b>TC</b>	training circular
<b>TM</b>	technical manual
<b>TTP</b>	tactics, techniques, and procedures
<b>UC</b>	utility cargo
<b>UH</b>	utility helicopter
<b>U.S.</b>	United States
<b>USC</b>	United States Code
<b>UTL</b>	utility
<b>WT</b>	warping tug

## SECTION II – TERMS

### **ambulance exchange point**

A location where a patient is transferred from one ambulance to another en route to a medical treatment facility. Also called AXP. (ATP 4-02.2).

### **casualty**

Any person who is lost to the organization by having been declared dead, duty status — whereabouts unknown, missing, ill, or injured. (JP 4-02).

### **casualty collection point**

A location that may or may not be staffed, where casualties are assembled for evacuation to a medical treatment facility. (ATP 4-02.2).

### **\*casualty evacuation**

The movement of casualties aboard nonmedical vehicles or aircraft without en route medical care. Also called CASEVAC.

### **mass casualty**

Any number of human casualties produced across a period of time that exceeds available medical support capabilities. Also called MASCAL. (JP 4-02).

### **medical evacuation**

The timely and effective movement of the wounded, injured, or ill to and between medical treatment facilities on dedicated and properly marked medical platforms with en-route care provided by medical personnel. Also called MEDEVAC. (ATP 4-02.2).

**medical treatment facility**

Any facility established for the purpose of providing medical treatment. This includes battalion aid stations, Role 2 facilities, dispensaries, clinics, and hospitals. (FM 4-02).

**patient**

A sick, injured or wounded Soldier who receives medical care or treatment from medically trained personnel. (FM 4-02).

**triage**

The process of sorting casualties based on need for treatment, evacuation, and available resources. (FM 4-02).

This page intentionally left blank.



## References

All URLs were accessed on 12 April 2021.

### REQUIRED PUBLICATIONS

These documents must be available to the intended users of this publication.

ATP 4-02.2. *Medical Evacuation*. 12 July 2019.

FM 1-02.1. *Operational Terms*. 9 March 2021.

FM 1-02.2. *Military Symbols*. 10 November 2020.

FM 4-02. *Army Health System*. 17 November 2020.

*DOD Dictionary of Military and Associated Terms*. January 2021.

### RELATED PUBLICATIONS

These documents contain relevant supplemental information.

### ARMY PUBLICATIONS

Most Army doctrinal publications are available online at: <https://armypubs.army.mil>.

AR 56-9. *Army Intratheater Watercraft Systems*. 2 October 2020.

ATP 3-04.1. *Aviation Tactical Employment*. 7 May 2020.

ATP 3-06. *Urban Operations*. 7 December 2017.

ATP 3-18.13. *Special Forces Use of Pack Animals*. 30 October 2014.

ATP 3-21.50. *Infantry Small Unit-Mountain and Cold Weather Operations*. 27 August 2020.

ATP 3-21.51. *Subterranean Operations*. 1 November 2019.

ATP 3-90.97. *Mountain Warfare and Cold Weather Operations*. 29 April 2016.

ATP 3-90.98. *Jungle Operations*. 24 September 2020.

ATP 4-02.3. *Army Health System Support to Maneuver Forces*. 9 June 2014.

ATP 4-02.43. *Army Health System Support to Army Special Operations Forces*. 17 December 2015.

ATP 4-15. *Army Watercraft Operations*. 3 April 2015.

ATTP 3-06.11. *Combined Arms Operations in Urban Terrain*. 10 June 2011.

FM 3-21.38. *Pathfinder Operations*. 25 April 2006.

TB MED 505. *Altitude Acclimatization and Illness Management*. 30 September 2010.

TB MED 508. *Prevention and Management of Cold-Weather Injuries*. 1 April 2005.

TC 3-97.61. *Military Mountaineering*. 26 July 2012.

TC 4-02.1. *First Aid*. 21 January 2016.

TC 18-09. *Special Forces Medical Support to Resistance*. 16 May 2019.

TM 1-1520-271-10-1. *Technical Manual Operator's Manual for US Army CH-47F Helicopters with CAAS 9.2.2 Software (NSN 1520-01-457-5179) (EIC RCH)*. 30 October 2020.

TM 4-15.21. *Army Watercraft Safety*. 15 September 2015.

### GENEVA CONVENTIONS

These documents are available online at: [https://www.loc.gov/rr/frd/Military\\_Law/pdf/GC\\_1949-I.pdf](https://www.loc.gov/rr/frd/Military_Law/pdf/GC_1949-I.pdf).  
*Geneva Conventions (I) and the Law of War for the Amelioration of the Condition of the Wounded and*

*Sick in Armed Forces in the Field.* 12 August 1949.

## JOINT PUBLICATIONS

These publications are available online at: <https://www.jcs.mil/doctrine/>.

JP 4-02. *Joint Health Services.* 28 September 2018.

## MULTI-SERVICE PUBLICATIONS

Most multi-Service publications are available online at: <https://armypubs.army.mil/>.

ATP 3-11.32/MCWP 10-10E.8/NTTP 3-11.37/AFTTP 3-2.46. *Multi-Service Tactics, Techniques, and Procedures for Chemical, Biological, Radiological, and Nuclear Passive Defense.* 16 May 2016.

ATP 3-90.99/MCTP 12-10D. *Desert Operations.* 7 April 2021.

FM 6-27/MCTP 11-10C. *The Commander's Handbook on the Law of Land Warfare.* 7 August 2019.

## NORTH ATLANTIC TREATY ORGANIZATION STANDARDIZATION AGREEMENTS

These documents are available online at: <https://nso.nato.int/>. (Must request access to protected site.)

STANAG 2040. *Stretchers, Bearing Brackets and Attachment Supports.* Edition 8. 24 November 2020 (AMedP-2.1. Edition B. Version 1. 24 November 2020).

STANAG 2228. *Allied Joint Doctrine for Medical Support.* Edition 4. 11 September 2019 (AJMedP-4.10. Edition C. 11 September 2019).

STANAG 2546. *Allied Joint Medical Doctrine for Medical Evacuation.* Edition 2. 29 August 2018 (AJMedP-2. Edition A. Version 1. 29 August 2018).

STANAG 3204. *Aeromedical Evacuation.* Edition 9. 6 July 2020 (AAMedP-1.1. Edition B. Version 1. 6 July 2020).

## UNITED STATES LAW

This document is available online at: <https://uscode.house.gov>.

10 USC 3583. *Armed Forces.*

## PRESCRIBED FORMS

This section contains no entries.

## REFERENCED FORMS

Unless otherwise indicated, DA forms are available on the Army Publishing Directorate website at: <https://armypubs.army.mil>. Unless otherwise indicated, Department of Defense forms are available on the Executive Services Directorate website at <https://www.esd.whs.mil/Directives/forms/>.

DA Form 2028. *Recommended Changes to Publications and Blank Forms.*

DA Form 7656. *Tactical Combat Casualty Care (TCCC) Card* (Available through normal publication channels).

DD Form 1380. *Tactical Combat Casualty Care (TCCC) Card* (Available through normal publication channels).

# Index

## A

ambulance exchange point,  
1-2—1-4, 7-1, A-1—A-3, D-1  
Army watercraft,  
causeway ferry, 4-19  
landing craft, mechanized 8,  
4-17—4-18  
landing craft, utility 2000, 4-17  
large tug 900, 4-19  
logistics support vessel,  
4-15—4-17  
small tug, 4-18  
warping tug, 4-19

## C

casualty collection point,  
discussion, 1-8—1-9, A-1, D-1  
example in open or wooded,  
figure 1-2, 1-9  
example in urban terrain,  
figure 1-3, 1-10  
casualty evacuation,  
company and troop level,  
1-5—1-6  
evacuation planning, 1-3—  
1-6,  
evacuation rehearsal, 1-5—1-7  
graphic aid, figure 1-1, 1-5  
levels of support, 1-2  
limitations, 1-1  
planned and unplanned,  
1-6—1-7  
platoon level planning, 1-6  
synchronize with staff, 1-3  
training and rehearsals, 1-6—  
1-8

## E

evacuation platforms,  
bus, 4-20—4-21

by contracted agencies, 4-21  
fixed-wing, 4-11—4-12  
ground, 4-1—4-10  
rail, 4-20  
rotary-wing, 4-12—4-15  
watercraft, 4-15—4-19  
evacuation request, Table C-1,  
C-1—C-3

## F

fixed-wing aircraft,  
C-12 Huron, 4-11  
C-26 Metroliner, 4-11  
UC-35 Citation, 4-12

## L

litter,  
decontamination mass  
casualty, 3-3  
improvised, 3-8—3-10  
litter folding rigid, 3-3  
litter straps, 3-8  
multihinged folding, 3-4  
pack animals, 3-10  
poleless nonrigid, 3-4  
procedures, appendix B  
rescue and transport  
system/nonrigid, 3-5  
rigid pole folding, 3-2  
spineboard, 3-6  
standard collapsible, 3-1

## M

mass casualty,  
management, 7-3  
plan, figure A-1  
situation, 7-1—7-2  
medical evacuation,  
ambulances, 1-1  
compared to casualty  
evacuation, 1-1

## R

rotary-wing aircraft,  
CH-47, 4-12—4-13  
LUH-72, 4-14—4-15  
UH-60, 4-14  
rough terrain,  
negotiating high angles,  
5-4—5-5  
negotiating low and steep  
angles, 5-5—5-6  
packaging, 5-3—5-4  
planning considerations,  
5-2  
techniques, 5-3

## S

specific environments,  
desert, 6-2  
extreme cold, 6-2—6-3  
jungle, 6-1—6-2  
mountains, 6-1  
urban, 6-4—6-5

## W

wheeled vehicles,  
all-terrain utility vehicles, 4-10  
JLTV family of vehicles, 4-9  
M871 22 1/2 ton cargo trailer,  
4-6  
M977 (HEMTT), 4-5  
M998 (HMMWV),  
2-person configuration, 4-2  
4-person configuration, 4-1  
M1075 Palletized Loading  
System, 4-6  
M1081 (LMTV), 4-4  
M1093 (MTV), 4-3  
MRAP, 4-7  
Stryker family of vehicles,  
4-8

This page intentionally left blank.

**ATP 4-02.13**

**30 June 2021**

By Order of the Secretary of the Army:

**JAMES C. MCCONVILLE**

*General, United States Army  
Chief of Staff*

Official:



**KATHLEEN S. MILLER**  
*Administrative Assistant  
to the Secretary of the Army  
2117601*

**DISTRIBUTION:**

*Active Army, Army National Guard, and United States Army Reserve:* Distributed in electronic media only (EMO).

This page intentionally left blank.



**PIN: 209454-000**