

**ATP 3-34.81
MCWP 3-17.4**

Engineer Reconnaissance

MARCH 2016

DISTRIBUTION RESTRICTION: Approved for public release; distribution is unlimited.

This publication supersedes FM 3-34.170/MCWP 3-17.4, 25 March 2008.

Headquarters, Department of the Army

FOREWORD

This publication has been prepared under our direction for use by our respective commands and other commands as appropriate.



JAMES H. RAYMER
Brigadier General, USA
Commandant
U.S. Army Engineer School



ROBERT S. WALSH
Lieutenant General, USMC
Deputy Commandant for
Combat Development and Integration

This publication is available at Army Knowledge Online
<<https://armypubs.us.army.mil/doctrine/index.html>>.

To receive publishing updates, please subscribe at
<http://www.apd.army.mil/AdminPubs/new_subscribe.asp>.

It is also available at the U.S. Marine Corps Web site
at Marine Corps Doctrine at <<https://www.doctrine.usmc.mil/>>

Change 1
Army Techniques Publication No. ATP 3-34.81/
MCWP 3-17.4

Headquarters
Department of the Army
Washington, DC, 30 January 2017

Engineer Reconnaissance

1. This change corrects the spelling of cord to chord. It also corrects formulas used in chapter 4.
2. A bar (|) marks new or changed material.
3. ATP 3-34.81/MCWP 3-17.4 is changed as follows:

Remove Old Pages

ii
4-7 through 4-9

Insert New Pages

ii
4-7 through 4-9

4. File this transmittal sheet in front of the publication for reference purposes.

DISTRIBUTION RESTRICTION: Approved for public release; distribution is unlimited.

This page intentionally left blank.

ATP 3-34.81, C1
MCWP 3-17.4
30 January 2017

By Order of the Secretary of the Army:

MARK A. MILLEY
General, United States Army
Chief of Staff

Official:



GERALD B. O'KEEFE
Administrative Assistant to the
Secretary of the Army
1701811

DISTRIBUTION:

Active Army, Army National Guard, and United States Army Reserve: Distributed in electronic media only (EMO).

This page is intentionally left blank.

Engineer Reconnaissance

Contents

	Page
PREFACE	v
INTRODUCTION	vi
Chapter 1 ENGINEER RECONNAISSANCE FRAMEWORK	1-1
Engineer Reconnaissance Tasks	1-1
Engineer Reconnaissance Team Capabilities and Limitations	1-4
Command and Support Relationships.....	1-7
Sustainment Considerations	1-8
Chapter 2 ENGINEER SUPPORT TO INFORMATION COLLECTION/INTELLIGENCE, SURVEILLANCE, AND RECONNAISSANCE	2-1
Planning.....	2-1
Staff Support.....	2-1
Reconnaissance	2-2
Chapter 3 RECONNAISSANCE SUPPORT	3-1
Support to Mobility	3-1
Support to Countermobility	3-8
Support to Survivability.....	3-9
Support to Other Environments and Activities.....	3-9
Support to Other Reconnaissance Types	3-18
Chapter 4 TECHNICAL RECONNAISSANCE—ROUTE CLASSIFICATION	4-1
Route Classification	4-1
Curve Calculations	4-6
Underpasses	4-15
Tunnels on Routes	4-15
Road Reconnaissance	4-18
Base Course and Subgrade	4-22
Chapter 5 TECHNICAL RECONNAISSANCE—ASSESSMENTS AND SURVEYS	5-1
Bridge Reconnaissance.....	5-1

Distribution Restriction: Approved for public release; distribution is unlimited.

*This publication supersedes FM 3-34.170/MCWP 3-17.4, 25 March 2008.

Contents

	Other Gap-Crossing Sites	5-2
	Engineer Resource Assessment.....	5-10
	Infrastructure Reconnaissance	5-10
	Environmental Reconnaissance	5-16
	Airfield Assessment.....	5-16
Appendix A	METRIC CONVERSION CHART	A-1
Appendix B	REPORTING.....	B-1
Appendix C	INFRASTRUCTURE RECONNAISSANCE	C-1
Appendix D	MILITARY LOAD CLASSIFICATION.....	D-1
Appendix E	TECHNICAL TOOLS AND RESOURCES	E-1
Appendix F	SIGNS	F-1
	GLOSSARY	Glossary-1
	REFERENCES.....	References-1
	INDEX	Index-1

Figures

Figure 1-1. Range of engineer reconnaissance capabilities.....	1-2
Figure 2-1. Route reconnaissance graphic control measures	2-5
Figure 2-2. Zone reconnaissance graphic control measures.....	2-7
Figure 2-3. Area reconnaissance graphic control measures	2-8
Figure 4-1. Route classification overlay	4-3
Figure 4-2. Route widths	4-5
Figure 4-3. Tape-measure method	4-7
Figure 4-4. Triangulation method.....	4-8
Figure 4-5. Chord method.....	4-9
Figure 4-6. Curve symbols.....	4-9
Figure 4-7. Percent of slope format	4-10
Figure 4-8. Map method to determine percent of slope.....	4-11
Figure 4-9. Pace method to determine percent of slope.....	4-12
Figure 4-10. Angle-of-slope method to determine percent of slope	4-13
Figure 4-11. Percent-of-slope symbols.....	4-14
Figure 4-12. Route construction symbol	4-14
Figure 4-13. Underpass symbols	4-15
Figure 4-14. Types of tunnel bores	4-16
Figure 4-15. Tunnel symbols	4-16
Figure 4-16. Overhead clearance measurements	4-17
Figure 4-17. Dimensions required for tunnels.....	4-18
Figure 4-18. Portal view of tunnel	4-19
Figure 4-19. Parts of a road	4-19

Figure 4-20. Load bearing capacity of roads with a flexible surface	4-22
Figure 5-1. Telltale.....	5-2
Figure 5-2. Ford symbols.....	5-4
Figure 5-3. Ferry symbols.....	5-6
Figure 5-4. Sample ferry symbols.....	5-6
Figure 5-5. Dimensions required for streams and rivers	5-7
Figure 5-6. Compass method to measure width of stream	5-8
Figure 5-7. Measuring gap width with a surveying instrument	5-8
Figure 5-8. Finding stream velocity	5-9
Figure 5-9. Assessment overlapping survey	5-11
Figure 5-10. Airfield damage categories	5-17
Figure B-1. Sample DD Form 3009.....	B-5
Figure B-2. Sample DD Form 3010.....	B-12
Figure B-3. Sample DD Form 3011	B-15
Figure B-4. Typical bridge spans.....	B-18
Figure B-5. Sample DD Form 3012.....	B-20
Figure B-6. Sample DD Form 3013.....	B-23
Figure B-7. Sample DD Form 3014.....	B-26
Figure B-8. Sample DD Form 3015.....	B-29
Figure B-9. Engineer resource symbols.....	B-31
Figure B-10. Sample DD Form 3016.....	B-33
Figure C-1. The infrastructure assessment and survey model	C-1
Figure E-1. ENFIRE components.....	E-4
Figure F-1. Hazard signs not included in the Geneva Convention.....	F-2
Figure F-2. Hazard signs included in the Geneva Convention.....	F-3
Figure F-3. Warning and enforcement signs	F-3
Figure F-4. Bridge signs	F-4
Figure F-5. Width and height signs	F-5
Figure F-6. Bridge sign containing technical information	F-5
Figure F-7. Typical multilane bridge classification.....	F-6
Figure F-8. Indicators of a damaged bridge	F-6
Figure F-9. Military route guide signs for axial routes	F-7
Figure F-10. Directional disks.....	F-8
Figure F-11. Guide signs for casualty evacuation routes.....	F-8
Figure F-12. Unit direction arrow.....	F-9
Figure F-13. Military detour signs	F-9
Figure F-14. Front sign	F-10

Tables

Introductory table-1. Modified Army and Marine Corps terms	vii
Introductory table-2. Rescinded Army and Marine Corps terms.....	vii
Table 4-1. Examples of the route classification format	4-4
Table 4-2. Traffic flow capability based on route width.....	4-6
Table 4-3. Conversion of degrees and mils to percent of slope	4-13
Table 4-4. Principle soil types	4-20
Table 4-5. Soil characteristics of roads and airfields	4-21
Table 4-6. Engineering properties of soil types	4-23
Table 4-7. Wheeled vehicle classification related to single wheel load	4-24
Table 4-8. Symbols for limiting characteristics	4-25
Table 4-9. Symbols for type of surface materials	4-25
Table 4-10. Examples of the road classification format	4-26
Table 5-1. Status color coding of infrastructure categories	5-12
Table A-1. Metric conversion chart	A-1
Table B-1. Route classification symbols	B-1
Table B-2. Engineer reconnaissance reports.....	B-4
Table B-3. Minimum roadway widths	B-17
Table B-4. Span construction types	B-17
Table B-5. Construction material	B-19
Table C-1. Infrastructure assessment considerations	C-3
Table F-1. Typical hazard, regulatory, and guide signs	F-1

Preface

ATP 3-34.81 provides techniques for the performance of tactical and technical engineer reconnaissance in support of military activities that are conducted across the full range of military operations. This publication supports doctrine found in ADP 3-0, FM 3-34, ADRP 5-0, and ADRP 6-0.

Although primarily oriented on the brigade combat team (BCT)/regimental combat team (RCT) based Marine air-ground task force (MAGTF) and below, the principal audience for ATP 3-34.81 is all members of the profession of arms. Commanders and staffs of Army and Marine Corps headquarters serving as joint task force or multinational headquarters should also refer to applicable joint or multinational doctrine concerning the range of military operations and joint or multinational forces. Trainers and educators throughout the Army and Marine Corps will also use this publication.

Commanders, staffs, and subordinates ensure that their decisions and actions comply with applicable United States (U.S.), international and, in some cases, host-nation laws and regulations. Commanders at all levels ensure that their personnel operate according to the law of war and the rules of engagement. (See FM 27-10.)

Unless this publication states otherwise, masculine nouns and pronouns do not refer exclusively to men.

Appendix A contains a metric conversion chart for the measurements used in this publication. For a complete listing of preferred metric units for general use, see Fed-Std-376B.

ATP 3-34.81 uses joint terms where applicable. Selected joint and Army terms and definitions appear in both the glossary and the text. Terms for which ATP 3-34.81 is the proponent (the authority) are italicized in the text and are marked with an asterisk (*) in the glossary. Terms and definitions for which ATP 3-34.81 is the proponent publication are boldfaced in the text. For other definitions shown in the text, the term is italicized and the number of the proponent publication follows the definition.

ATP 3-34.81 applies to Active Army, Army National Guard/Army National Guard of the United States, United States Army Reserve, Marine Corps, and Marine Corps Reserves unless otherwise stated.

The proponent of ATP 3-34.81 is the United States Army Engineer School. The preparing agency is the Maneuver Support Center of Excellence (MSCoE) Capabilities Development and Integration Directorate; Concepts, Organizations, and Doctrine Development Division; Doctrine Branch. Send comments and recommendations on DA Form 2028 (*Recommended Changes to Publications and Blank Forms*) to Commander, MSCoE, ATTN: ATZT-CDC, 14000 MSCoE Loop, Suite 270, Fort Leonard Wood, MO 65473-8929; by e-mail to <usarmy.leonardwood.mscoe.mbx.cdiddcoddengdoc@mail.mil>; or submit an electronic DA Form 2028. Marine Corps readers of this publication are encouraged to submit suggestions and changes to Deputy Commandant for Combat Development and Integration, ATTN: C116, 3300 Russell Road, Suite 204, Quantico, VA 22134-5021 or by e-mail to <doctrine@usmc.mil>.

Introduction

The three engineer disciplines are combat (with the capabilities and activities of mobility, countermobility, and survivability [M/CM/S]), general, and geospatial engineering. These disciplines include significant reconnaissance capabilities. The three engineer disciplines include extensive discussion on integrating the planning for, and conduct of, engineer reconnaissance support within the tactical operations of the combined arms team. This publication discusses the capability resident within combat engineer units to form and employ engineer reconnaissance teams (ERTs). It also describes the capability resident within general engineer elements to form and employ ERTs, augment combat engineer ERTs, or provide assessment and survey teams. Finally, geospatial engineering enables reconnaissance and may play a large role, especially during the planning process.

Engineer reconnaissance, like chemical, biological, radiological, and nuclear (CBRN) and other technical applications, is not a form of reconnaissance. Engineer reconnaissance is a focused application of special or unique capabilities supporting reconnaissance, and it is applicable to all forms of reconnaissance. The engineer disciplines provide reconnaissance capabilities that vary in linkages to warfighting functions, degrees of technical expertise, and effort applied to the assigned mission and tasks. Engineer reconnaissance is directly linked to geospatial intelligence because combat and general engineer units use technical measuring or survey devices to confirm, correct, or update the accuracy of available geospatial information. After analysis and comparison against other intelligence collections, this updated geospatial information becomes intelligence, which feeds the commander's decisionmaking process.

The engineer contribution to operational success is highly desired by the commander. Demands for engineer reconnaissance support will often exceed capabilities. These capabilities are spread thin, and they compete with the commander's needs for other engineer applications. The same engineer elements and capabilities are often required for each of these areas. Resolution of these competing priorities is one of the goals of the planning process. The staff-running estimate is created during mission analysis, and the engineer staff planner identifies the specified and implied engineer tasks (more than M/CM/S) and their associated purposes. This results in the recommendation of essential tasks for M/CM/S to the supported commander.

Finally, this publication is written with the acknowledgement that the operational environment is more variable now. Engineers must be prepared to go into any operational environment and perform a full range of reconnaissance tasks in support of the maneuver commander while dealing with a wide range of threats and other influences. It builds on the collective knowledge and experience gained through nearly a dozen years of sustained military operations and exercises. It is rooted in time-tested principles and fundamentals, while accommodating new technologies and diverse threats to national security.

This publication consists of five chapters and six appendixes that discuss the integration of engineer reconnaissance within the operational planning, execution, and assessment process that is presented in ADRP 5-0, ADRP 6-0, and MCWP 5-1. The following is a brief description of each chapter and appendix:

- Chapter 1 provides a doctrinal framework for the provision of engineer reconnaissance capabilities resident within engineer disciplines and supporting the warfighting functions. This chapter describes a range of tactical to technical engineer reconnaissance capabilities, and it provides capabilities and limitations of the ERT.
- Chapter 2 provides doctrine for integrating the planning for engineer reconnaissance within information management and planning processes of the combined arms team. This chapter specifically addresses integration of geospatial support, and it provides specific considerations for integration of engineer reconnaissance.
- Chapter 3 provides doctrine for integrating the application of engineer reconnaissance within tactical reconnaissance of the combined arms team. This chapter also addresses considerations for the sustainment of engineer reconnaissance elements.
- Chapter 4 provides doctrine for the conduct of technical engineer reconnaissance of routes. The ERTs conduct route reconnaissance with a specified additional focus on required technical information.

- Chapter 5 provides doctrine for the conduct of engineer assessments and surveys that provide engineer reconnaissance support at the technical level of reconnaissance. Assessment and survey teams conduct reconnaissance specifically focused on collecting detailed technical information.
- Appendix A provides the user with a metric conversion table.
- Appendix B illustrates the preparation of required engineer reconnaissance reports and forms.
- Appendix C incorporates the form developed for infrastructure assessment. The examples are used for infrastructure in sewage, water, electric, academics, trash, medical, (public) safety and other considerations (SWEAT-MSO).
- Appendix D provides techniques for determining military load classification (MLC) of bridges. The MLC for bridging is explained fully in TM 3-34.22/MCRP 3-17.1B.
- Appendix E provides guidelines for the use of signs at bridges, key locations, or constrictions along a route that promotes efficient traffic control and limits the impact of hazardous areas along the route.
- Appendix F includes a collection of other useful tools and resources.

When this publication uses two terms separated by a slash, the first term is the Army term and the second term is the Marine Corps term. Key differences in Army and Marine Corps terms include—

- Brigade combat team/regimental combat team-based MAGTF (written in this publication as BCT/RCT).
- Environmental officer/environmental compliance officer (written in this publication as environmental officer/environmental compliance officer).
- Intelligence preparation of the battlefield/intelligence preparation of the battlespace (written in this publication as intelligence preparation of the battlefield/battlespace).
- Mission analysis/problem framing (written in this publication as mission analysis/problem framing).
- Mission, enemy, terrain and weather, troops and support available, time available, civil considerations (METT-TC)/mission, enemy, terrain and weather, troops and support available, time available (METT-T) (written in this publication as METT-T[C]).

See introductory table-1 and introductory table-2 for term changes.

Introductory table-1. Modified Army and Marine Corps terms

<i>Term</i>	<i>Remarks</i>
infrastructure reconnaissance	updated to reflect current team and requirement

Introductory table-2. Rescinded Army and Marine Corps terms

<i>Term</i>	<i>Remarks</i>
assessment	common English usage
obstacle intelligence	common English usage
route classification	term source JP 3-34
survey	common English usage
Legend:	
JP	joint publication

This page intentionally left blank.

Chapter 1

Engineer Reconnaissance Framework

Combined arms is the synchronized or simultaneous application of several arms (infantry, armor, field artillery, engineers, aviation) to achieve an effect on the enemy that is greater than when used separately or in sequence. Engineer support to the combined arms team adds key capabilities that ensure freedom of maneuver and preserve combat power. An important measure of effectiveness of the integration of lethal and nonlethal capabilities is the degree that the commander can concentrate combat power at the critical place and time and the agility with which the commander can shift those concentrations to new situations. Engineer support adds reconnaissance capabilities to improve the commander's understanding about the enemy and environment, enabling the concentration and agility needed. This chapter begins the discussion of engineer reconnaissance and the application of those capabilities integrated and synchronized with other tasks and systems united by the combined arms commander toward the common purpose of accomplishing the mission.

ENGINEER RECONNAISSANCE TASKS

1-1. Engineer reconnaissance consists of tasks that are undertaken to obtain (by visual observation or other detection methods) information about the activities and resources of an enemy or adversary or to secure data concerning the meteorological, hydrographical, or geographical characteristics of a particular area. Reconnaissance is a focused collection effort. Reconnaissance is performed before, during, and after missions to provide information used in the intelligence preparation of the battlefield/battlespace process and by the commander to format, confirm, or modify a course of action. Engineer units do not have designated reconnaissance organizations. Engineer reconnaissance is prescribed and task-organized in orders, but it depletes resources from other engineer missions.

1-2. The responsibility for conducting reconnaissance does not reside solely with specifically organized units. Regardless of its primary function or physical location, every unit has an implied mission to report information about the terrain, civilian activities, and friendly and enemy force dispositions. Although units share the implied reconnaissance mission, the commander focuses specifically organized reconnaissance units on the highest priority collection requirements. Ground maneuver formations (such as the BCT/RCT) possess organic reconnaissance, surveillance, and target acquisition capabilities. These capabilities permit them to exploit reconnaissance initiative and maintain operational tempo. The BCT/RCT is also able to access theater and national resources. The BCT/RCT ability to develop the situation in and out of contact and to act first with decisiveness is enhanced by this robust reconnaissance capability.

1-3. The maneuver commander must understand the capabilities and limitations of reconnaissance assets to judiciously employ them and avoid assigning a mission to a unit that does not possess the ability to accomplish the assignment. With the robust reconnaissance capability now available in support of the BCT/RCT, the commander must know the capabilities and limitations (training, equipment) of their reconnaissance assets. The commander ensures that these assets are employed on missions within their capabilities. Although reconnaissance primarily relies on the human dynamic rather than technical means, the situation may require collecting a higher degree of technical information than nonspecialized units possess. An area with suspected CBRN contamination, for example, must be targeted for reconnaissance by assets equipped to determine the type and level of contamination present and protection from the contamination. Supporting units (engineers, CBRN, explosive ordnance disposal [EOD], military police) have specialized capabilities to collect technical information that complements the overall reconnaissance

effort of the force. This is especially true with respect to the collection of technical information by engineer reconnaissance and survey teams operating throughout the battlefield/battlespace.

RANGE OF ENGINEER RECONNAISSANCE

1-4. Engineer reconnaissance, like CBRN and other technical specialties, is not a form of reconnaissance. Instead, it is a focused application of technical capabilities supporting reconnaissance and is applicable to all forms of reconnaissance (route, zone, area, reconnaissance in force, and special reconnaissance). Each discipline provides varying degrees of technical expertise and effort within the assigned mission and tasks. The tasks and levels of expertise provide an overlap from discipline to discipline. For example, there is no clean dividing line from the technical effort required for the combat engineering task of classifying a route for combat vehicle traffic to the general engineering task of conducting road reconnaissance to estimate the effort required for the upgrade of a main supply route. The combat engineering task will effectively address classification of the route, but it will also provide information useful in the general engineer estimate of a road segment. Similarly, the general engineer estimate will address the effort required for an upgrade and provide information useful in the classification of the route. Army geospatial engineering is employed in support of both and in varying degrees as required by the task and situation. Figure 1-1 graphically describes the technical information provided by engineer reconnaissance tasks. This graphic is not intended to define absolutes but rather to illustrate the general relationships and linkages between the engineer functions and the technical and tactical engineer reconnaissance capabilities.

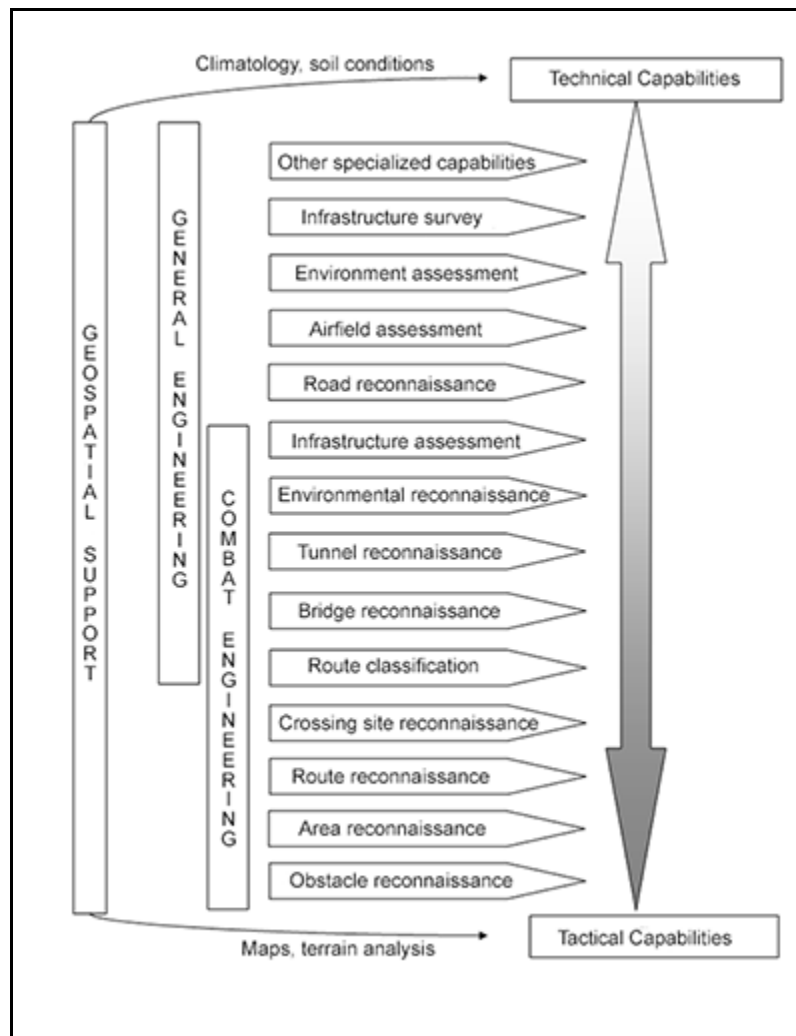

Figure 1-1. Range of engineer reconnaissance capabilities

1-5. Engineer units do not have dedicated reconnaissance elements within their structure. Combat and general engineers are task-organized as required by the situation, based on METT-T[C], and combat and general engineers may be teamed separately, with other elements from the BCT/RCT, or other engineer organizations.

ENABLING AND TEAMING WITH OTHER RECONNAISSANCE CAPABILITIES

1-6. The ERTs teamed directly with dedicated reconnaissance assets increase the tempo and effectiveness of the reconnaissance mission. Combat engineers are typically task-organized in direct support of maneuver units. Under this command relationship, the maneuver unit commander can employ the organic reconnaissance element and a combat engineer ERT to collect information that will satisfy tactical information requirements. When employed in this fashion, the reconnaissance element conducts the overall reconnaissance mission while the ERT focuses on the collection and evaluation of engineer specific technical information (complex obstacles, bypasses, river crossing sites, landing zones, combat road or trail capacity). Matching a single or multiple ERTs with the organic reconnaissance element is the most common employment method used by BCT/RCT commanders. To achieve the maximum benefit of this method of employment, it is important for planners to ensure that the ERT has the same level of mobility as the reconnaissance element. Additionally, careful consideration should be taken regarding the scope of tasks assigned to the combat engineer unit. Committing ERTs to the reconnaissance mission will divert manpower from the direct support combat engineer element to maneuver unit reconnaissance elements for tactically oriented reconnaissance where engineer expertise supports the commander's information requirements. The reconnaissance unit conducts the overall mission while the ERT focuses on the more technical information required (such as detailed information on a complex obstacle, proposed crossing site, or route capacity). While various engineers are available to be task-organized to reconnaissance units, the teaming of engineers into the reconnaissance forces directly supporting the BCT/RCT is the most common application.

1-7. General engineer units, when not directly supporting combat engineer units, will typically form task-organized ERTs to perform general engineer surveys and technical assessments. These ERTs will concentrate on the collection and evaluation of technical information related to infrastructure and resources of the host nation. Depending on the technical nature of information required, these ERTs may include credentialed civil engineer subject matter experts in permissive operational environments while access to technical reachback centers may be applicable in uncertain or hostile environments.

COMBAT ENGINEER RECONNAISSANCE TASKS

1-8. Combat engineers support all forms of reconnaissance. Engineer reconnaissance missions are fully integrated within the BCT/RCT reconnaissance effort. Because they are conducted by engineers, it will include some degree of focus on technical information as required by the commander's reconnaissance guidance. The reconnaissance should focus on restrictive aspects of equipment assigned to the ERT tasking unit. Considerations for reconnaissance restriction designations may come from the unit table of organization and equipment, technical manuals, or any other known physical characteristics of unit equipment that will use the reconnoitered area.

1-9. The majority of engineer reconnaissance capabilities enable the collection of technical information in support of combat engineering. Reconnaissance in support of M/CM/S is conducted primarily by ERTs (composed of combat engineers) and focuses on collecting tactical and technical information to support the BCT/RCT mobility. The specific combat engineer reconnaissance tasks include, but are not limited to—

- Obstacle reconnaissance focused on bypass or breach of obstacles.
- Route reconnaissance focused on route clearance.
- Area reconnaissance focused on explosive hazards, requiring area clearance.
- Crossing site reconnaissance focused on determining requirements for a gap crossing.
- Route reconnaissance focused on establishing a combat road or trail.
- Reconnaissance of planned or existing sites and facilities supporting the BCT/RCT.
- Obstacle reconnaissance (including demolition obstacles) focused on establishing friendly obstacles integrated with fires.
- Obstacle reconnaissance in preparation for target turnover.

- Area reconnaissance focused on establishing vehicle fighting positions and protective works.
- Area reconnaissance in support of urban combat.
- Reconnaissance of tunnels and underground structures.
- Reconnaissance to establish an initial assessment of infrastructure factors.
- Reconnaissance in complex terrain.

GENERAL ENGINEERING RECONNAISSANCE TASKS

1-10. General engineering reconnaissance is similar in focus to the reconnaissance tasks that support missions linked to BCT/RCT sustainment. Technical capabilities are distinguished from the support provided to combat engineer missions and from tactical sustainment missions by the level at which the requirements are identified and addressed. At the tactical level, the BCT/RCT may have a general engineer element in direct support to maintain or upgrade a specified main supply route in the BCT/RCT area of operations (AO). General engineers working at the operational level will conduct reconnaissance to identify requirements for large-scale improvement and maintenance of theater ground line of communications. Technical reconnaissance capabilities are typically conducted by a general engineering assessment team or survey team to gather the technical information required for the following general engineering tasks:

- Maintaining and upgrading ground lines of communications.
- Constructing or repairing bridges.
- Supporting airfields and heliports.
- Supporting seaports.
- Supporting survivability.
- Maintaining real estate and real property.
- Procuring and producing construction materials.
- Supporting base camps and support areas.
- Generating and distributing power.
- Maintaining petroleum pipeline and storage facilities.
- Supporting water production and distribution (including well drilling).
- Supporting underwater and other specialized construction.
- Surveying infrastructure.

1-11. Technical capabilities include robust support from joint Service, multiagency, contractor, host nation, and reachback elements. Field force engineering is the broad range of reachback capabilities, which are part of the U.S. Army Corps of Engineers and Naval Facilities Engineering Command. Field force engineering is linked through the engineer element on the ground to apply a higher degree of technical expertise to the engineer mission. (See FM 3-34, FM 6-0, and MCWP 3-17 for additional information.)

ENGINEER RECONNAISSANCE TEAM CAPABILITIES AND LIMITATIONS

1-12. The ERTs are added according to the mission needs. The Army BCT has a significant collection capability inherent in its organic cavalry squadron, maneuver battalion, and military intelligence company. The Army BCT may be augmented with information collection assets from echelons above the BCT. This section describes the capabilities and limitations of task-organized ERTs formed by engineers supporting the BCT. This includes the engineer battalion organic to each of the BCT structures and augmenting engineer units.

1-13. The Marine Corps structure includes combat engineer capabilities task-organized in direct support of the RCT. While the combat engineer elements supporting the RCT do not include organic or dedicated reconnaissance formations, they do have the capability to conduct tactical reconnaissance as required by the situation. The RCT will rely more heavily on joint Service support or other general engineer augmentation than its BCT counterpart to provide the technical range of support.

1-14. The employment of engineers in a reconnaissance role enhances the effectiveness of combat engineer support and the tempo and technical quality of the reconnaissance. The commander should be aware of the ERT capabilities and understand the trade-offs between using engineer assets in a reconnaissance role versus using them in other roles.

FORMATION OF AN ENGINEER RECONNAISSANCE TEAM

1-15. ERTs represent task-organized elements within larger engineer units. Detailed preparations are necessary to facilitate their rapid deployment and success. This can include designating certain personnel to an ERT battle roster, providing specialized training for those personnel (how to operate measuring equipment to collect technical information, how to employ tactical communications/information systems to submit ERT reports), establishing an ERT standardized procedure, and conducting rehearsals using standardized procedure. Based on the scope and scale of the assigned mission, the size of an ERT may be a team, squad, platoon, or larger.

1-16. Regardless of the task organization that creates the ERT, units have to dedicate a large amount of training time toward developing an effective ERT. This training may include—

- Training events with the cavalry squadron to develop a strong working relationship.
- Reconnaissance fundamentals.
- Integration with brigade and engineer reconnaissance elements in a nearly habitual relationship to develop the trust and familiarity necessary to succeed on the battlefield.
- Reporting, calling for fires, first aid, land navigation, demolitions, minefield indicators, foreign mine recognition, dismounted movement techniques, vehicle and equipment maintenance, helicopter insertion, resupply, extraction, relay, and retransmission procedures.
- Operation of digital communications and automated reconnaissance systems to facilitate passing reconnaissance information.

1-17. The ERT is normally task-organized for each specific mission. The ERT elements are drawn from the assigned engineer organization. The ERT—

- Increases the supported unit reconnaissance capabilities concerning complex obstacle systems, enemy engineer activities, and the details of mobility along a route.
- Conducts an analysis by providing technical information of obstacles to determine the assets needed to reduce any obstacle detected.
- Marks bypasses of obstacles based on guidance from the supported commander. This guidance includes whether to mark bypasses and the direction the force should maneuver when bypassing an obstacle.
- Assists in guiding the breach force to the obstacle for breaching.
- Assists in gathering enemy engineer information.
- Provides detailed technical information on routes (including classification) and specific information on bridges, tunnels, fords, and ferries along the route.
- Provides the initial level technical information required for an airfield assessment.
- Conducts reconnaissance with a specified focus on the initial technical information required for infrastructure assessments.

1-18. An ERT conducts missions as part of a larger combined arms force, directly augmenting the reconnaissance element. More than one ERT may be employed if multiple named areas of interest (NAIs) need to be observed in dispersed locations. The ERT may conduct its reconnaissance dismounted.

1-19. The dismounted element mission is to locate and report the information required by the supported commander according to the information collection or intelligence collection plan. This information can be transmitted by any available communication or information system means, per the supported unit communication plan and the information collection or intelligence collection plan.

1-20. The supported element mission is to maintain communication with the dismounted ERT element and higher headquarters. The supported element is responsible for relaying the information collected by the dismounted element to the appropriate communications node. The supported element ensures that the team

equipment is not discovered by the enemy. The obstacle information collected by a reconnaissance team is also sent to its parent engineer headquarters, when possible. The secondary mission of the supported element is to be prepared to go forward and complete the reconnaissance if the dismounted element is unsuccessful.

1-21. The supported element is responsible for the ERT security during their reconnaissance. Operational limitations of the ERT include personnel vulnerability to detection and targeting by the enemy when the ERT needs to dismount to take key measurements of reconnoitered structures or terrain features.

LIMITATIONS OF AN ENGINEER RECONNAISSANCE TEAM

1-22. One of the high-frequency tasks associated with reconnaissance missions is locating obstacles and restrictions that may affect the trafficability along a route. The ERT should not be confused with a route clearance team, which is task-organized to detect and clear obstacles along a route. The purpose of this ERT is to determine how best to overcome the obstacle effects. The tasks that are associated with this reconnaissance may be to estimate the reduction assets necessary to reduce the obstacle, to mark the best location to breach, or to recommend a bypass of the obstacle. If the obstacle is to be bypassed, the reconnaissance team should be prepared to provide guides and markings. The reconnaissance should include the location of supporting enemy positions and possible point of breach locations for the obstacle. See JP 3-15 for a discussion of obstacle types.

1-23. An ERT primary task with regard to tactical and protective obstacles is the reconnaissance of those obstacles and locating and marking bypasses around obstacles and restrictions. An ERT has the following limitations:

- An unaugmented ERT is extremely limited in its ability to destroy or repel enemy reconnaissance units and security forces.
- The distance the ERT can operate away from the main body is restricted by the range and type of communications, the range of supporting indirect fires, and the ability to receive sustainment.
- The amount of technical reconnaissance equipment when organic transportation is not used.

TECHNICAL AUGMENTATION OF AN ENGINEER RECONNAISSANCE TEAM

1-24. General engineer units can provide a range of additional technical expertise capabilities in direct support of an ERT. Technical support can take the form of augmentation of the ERT or reachback support. In some cases, the ERT mission will provide the initial technical information to plan or focus the employment of follow-on assessment or survey elements from the general engineer force. General engineering technical expertise can include —

- Vertical or horizontal construction.
- Port or pipeline construction.
- Power generation and distribution.
- Army water well drilling and distribution.
- Divers and underwater construction.
- Real estate and facilities management.
- Environmental support.
- Structural engineering and antiterrorism/force protection.
- Explosive ordnance clearance agent/Marine Corps professional military education system school trained personnel

1-25. Any person or organization that has received basic search training is a resource; they may be able to collect specialized information to support the intelligence picture. Even relatively trivial information provided by a search-aware trained individual may provide the necessary information to launch future search activities. (See FM 3-34.210/MCRP 3-17.2D for additional information on search.)

1-26. The search advisor is usually an experienced company or troop level officer, warrant officer, or senior noncommissioned officer who has received intermediate or advanced search advisor training. A search advisor conducts detailed search planning, preparation, rehearsals, and mission execution. A unit commander may delegate authority to the search advisor, as appropriate, to accomplish the search mission. The specific

authorities delegated depend on the situation and the personalities involved. The search advisor can directly augment an ERT when the reconnaissance mission is planned in support of search. When unavailable to augment or accompany the ERT, the search advisor may provide specific information requirements for the reconnaissance focus in support of planned search tasks.

ASSESSMENTS AND SURVEYS

1-27. An ERT can conduct assessments and surveys at the operational level in support of the general engineering function. The assessment or survey teams are generally not employed when direct contact with the enemy is likely. Rather, engineer assessment or survey is typically conducted in a relatively secure area and is focused on specific and detailed technical information required for a future engineered, or at least heavily engineered, mission. When operating within an assigned maneuver area, the assessment or survey team must fully coordinate its activity with the maneuver unit. Additional specialized assistance may also be provided from assets not typically organized into tactical units and may include other military resources (U.S. Army Corps of Engineers, Naval Facilities Engineering Command) or other unified action partners.

1-28. An ERT assessment is a judgment about something based on a technical understanding of the situation. An assessment may follow the same format as a survey, but in the case of the assessment, time or specific technical expertise is not adequate to call it a survey. The assessment requires less time, but it provides less technical detail. Other, nonspecialized reconnaissance elements may also do assessments, but surveys require specialized technical expertise.

1-29. An ERT survey looks at or considers something closely, especially to form a technical opinion. Examples include an environmental baseline survey (see ATP 3-34.5/MCRP 4-11B), an infrastructure survey, and the more technical components of route classification.

1-30. Assessment and survey teams are specifically tailored to collect the detailed technical information. The teams include the variety of specialties necessary for the supported mission. Substantial additional technical capabilities are added as necessary from unified action partners. Field force engineering is the broad range of activities linked through the general engineer element to apply a high degree of technical expertise to the engineer technical reconnaissance capability.

COMMAND AND SUPPORT RELATIONSHIPS

1-31. Engineers are task-organized in a variety of ways, depending on the mission and current requirements. This task organization drives an ERT command or support relationship. Additionally, the supported unit commander may task-organize the reconnaissance team as appropriate. (See FM 6-0 and MCWP 3-17 for a full discussion on command and support relationships.)

1-32. In an operational control relationship, a reconnaissance team receives all of its tasking and missions from the supported unit. The supported unit commander retains the same authority over the reconnaissance team as their organic units; the supported unit commander may task-organize the reconnaissance team, as appropriate. Sustainment support comes from the parent engineer unit unless the engineer battalion has coordinated with the supported unit for certain classes of supply.

1-33. In a direct support relationship, a reconnaissance team answers directly to the supported unit requests for support. Sustainment support is provided by the parent engineer unit, and the reconnaissance team is commanded by its parent engineer unit commander.

1-34. In a general support relationship, a reconnaissance team receives missions and all support from its parent engineer unit. However, this is not a preferred method of a command support relationship.

1-35. An ERT can be employed using several purposes, and each purpose has advantages and disadvantages. These advantages and disadvantages include the following:

- **Integrating as part of the brigade information collection/intelligence collection effort.** In this method, an ERT is integrated into the brigade collection effort. This effort normally includes other assets and receives the same types of support and sustainment as the rest of the brigade reconnaissance assets. It is imperative that the engineer unit providing the ERT understands all aspects of the plan to employ the ERT. At a minimum, the ERT leader should attend the brigade information collection/intelligence collection rehearsal. The higher headquarters continues to track the ERT through the operation. Resources (maintenance and personnel status, verification of the team position, activation of no-fire areas) must be closely monitored. The efficient dissemination of the information collected by the team is also a critical task of the higher headquarters staff.
- **Assigning BCT/RCT NAIs in a task force AO.** Under this method, an ERT receives its reconnaissance objectives from brigade through an engineer unit supporting a maneuver battalion, squadron, or task force. The ERT leader should link up with the appropriate task force scout platoon leader upon receiving the mission from the providing engineer unit. The engineer unit must ensure that the necessary instructions to the appropriate task forces are included in the brigade operations order, especially if the task forces are expected to provide logistical support to the ERT (including casualty evacuation and vehicle recovery support). The team leader should be present at the scout platoon leader's operation order and rehearsals to ensure understanding of the scout platoon plan. To reduce the risk of fratricide, the ERT leader must provide the plan to the scout platoon leader. The ERT should report checkpoints and locations on the same net that the task force scouts are operating on (for example, task force operations on the intelligence net). All information reports should be sent to the task force and the engineer unit. The unit should then pass the information to the brigade and its subordinate elements. This employment concept should be used anytime the ERT works closely with task force scouts.
- **Working under task force control.** In this method, ERTs are placed under the task force control to look at the NAIs that the brigade tasks to the task force or expects the task force to develop requiring engineer expertise (possibly a task force breach). This method involves the least amount of coordination and planning for the engineer unit that is providing the ERT. However, the responsibility to plan and monitor ERT activities now falls to the task force engineer. Although the task force decides how to use the ERT, the task force engineer must be involved in the planning details to ensure that the team is properly used, is integrated into a sound information collection/intelligence collection plan, and receives the necessary support.

1-36. In most cases, information collection/intelligence collection assets will be attached to a subordinate command to ensure integration. However, the brigade may keep some assets under brigade control and assign them their own AO or have them operated independently in another AO. The organic engineer headquarters is responsible for command oversight of these independent operators, while the asset has the requirement to ensure coordination with the respective maneuver commander. Examples of information collection/intelligence collection assets operating independent of subordinate units include an unmanned aircraft system (UAS) launch and recovery site.

SUSTAINMENT CONSIDERATIONS

1-37. An engineer unit providing an ERT will likely be able to provide only a limited amount of logistical support, especially after the ERT crosses the line of departure (LD). For this reason, it is essential that the supported unit understand the ERT requirements and embrace the support of the element. The supporting engineer unit must coordinate closely with the supported element commander for support that they cannot provide organically or that can be provided more effectively by the supported maneuver unit.

1-38. For engineer units augmenting the BCT/RCT, staff coordination must be made at the appropriate task-organized unit so that the supporting unit requirements are included in sustainment planning conducted by the supported unit. Within the BCT/RCT, the maneuver and engineer battalion/squadron commanders ensure that support is provided for organic and attached elements and supporting units.

Chapter 2

Engineer Support to Information Collection/Intelligence, Surveillance, and Reconnaissance

The commander's decisionmaking process is directly supported by situational awareness and understanding that is provided by timely combat reporting and accurate intelligence. The collection, analysis, and dissemination of accurate intelligence satisfy the commander's information requirements, which remove some uncertainty from the commander's decisionmaking. Engineer units provide the means to collect specific technical information to answer the supported unit commander's information requirements.

PLANNING

2-1. A BCT/RCT conducts information collection/intelligence collection activities that support the overall intelligence estimate. Information collection/intelligence collection is multifaceted and develops, synchronizes, and integrates intelligence from a multitude of collection sources to eliminate functional stovepipes for planning, reporting, and processing information and producing intelligence. Information collection/intelligence collection must be nested from division to battalion or squadron level to ensure the integration of available assets toward a single purpose. This integration results in increased security and flexibility to gain and maintain the initiative at the tactical level, which is the focus of the BCT/RCT and its subordinate elements.

2-2. Information collection/intelligence collection is a continuing activity. It allows units to produce a continuous feed of relevant intelligence on the enemy, environment, and civil considerations that are required by the commander when making critical decisions. This information answers requirements developed throughout the operations process. Timely and accurate intelligence developed by aggressive and continuous information collection/intelligence collection encourages audacity. This intelligence facilitates actions that negate enemy strengths or exploit weaknesses (vulnerabilities).

STAFF SUPPORT

2-3. The BCT/RCT commander and the executive officer must ensure an integrated staff process to conduct planning and dissemination of information collection/intelligence collection orders. Given the complex nature of the operational environment, combined with the significantly enhanced collection capabilities of the BCT/RCT, it is imperative that the intelligence staff officer (S-2), operations staff officer (S-3), fires coordinator, engineer staff, and other required staff work together to develop the information collection/intelligence collection plan. The engineer is especially critical in ensuring that the reconnaissance effort will support the mobility and survivability of the BCT/RCT. Further, the significance of the information collection/intelligence collection process on unit success dictates the involvement of the entire staff. This allows the S-2 to focus on fusing information from national through tactical intelligence collections, better enabling the S-2 to provide the commander with timely and accurate intelligence assessments. The commander uses the fused intelligence provided by information collection/intelligence collection to make decisions that allow him to place combat effects on the enemy at the time and location chosen by the commander, to impede, harass, or attrite the enemy and then to employ maneuver forces to destroy it. The commander then employs maneuver forces to destroy it. The BCT/RCT executive officer integrates the staff actions (S-2, S-3, the rest of the staff, and the reconnaissance element) to identify collection requirements and implement the information collection/intelligence collection plan.

2-4. With staff participation, the BCT/RCT S-2 supports the information collection/intelligence collection effort by focusing the collection, processing, analysis, and intelligence products on the critical needs of the commander. The BCT/RCT S-3, in coordination with the S-2, tasks and directs the available information collection/intelligence collection assets to answer the commander's information requirements. The required information is obtained through various detection methods and systematic observation, reconnaissance, and surveillance. This task is a continuous process, and it has four subtasks—

- Perform intelligence synchronization.
- Perform information collection/intelligence collection integration.
- Conduct surveillance.
- Conduct reconnaissance.

RECONNAISSANCE

2-5. Engineer units are uniquely trained and equipped to obtain data concerning the hydrographic or geographic characteristics of a particular area. This permits them to collect data in support of tactical or operational-level reconnaissance objectives. This can include data related to obstacles, surface drainage, vegetation, cultural features, beaches, and soil composition. To ensure that the engineer fits effectively within the combined arms team, it is critical for the engineer reconnaissance planners and team leaders to understand the language of the maneuver commander's reconnaissance plan. Similarly, the staff planners and team leader must describe their engineer reconnaissance capabilities and support requirements in terms of the mission to ensure integration with the overall reconnaissance effort. In determining which method (push or pull) and technique used (mounted, dismounted, aerial, or sensor), the staff further describes how the reconnaissance will be conducted.

COMMANDER'S RECONNAISSANCE GUIDANCE

2-6. The BCT/RCT commander's reconnaissance guidance is issued early in the operational planning process. The commander's reconnaissance guidance covers the following considerations:

- Focus of reconnaissance.
- Tempo of reconnaissance.
 - Stealthy.
 - Forceful.
 - Deliberate.
 - Rapid.
- Engagement criteria (lethal and nonlethal), if any.
 - Aggressive.
 - Discreet.

Focus

2-7. Reconnaissance focus defines where and on what the reconnaissance team needs to concentrate its information gathering activities. Reconnaissance focus allows the commander to select the critical tasks to accomplish and with which assets. Reconnaissance focus must be linked to the tasks of answering the commander's critical information requirements, supporting targeting (lethal and nonlethal), and filling additional voids in the information requirements. The reconnaissance objectives of the ERT must be focused, at a minimum, on one or more of the following:

- **Infrastructure.** Infrastructure covers those systems that support the indigenous inhabitants, economy, and government of an area. Destroying, controlling, or protecting vital parts of the infrastructure can isolate the enemy from potential sources of support. Because these systems are inextricably linked, destroying or disrupting any portion of the urban infrastructure can have a cascading effect (intentional or unintentional) on the other elements of the infrastructure.
- **Terrain.** Terrain-focused reconnaissance identifies voids in terrain-related information requirements that a map or digital analysis simply cannot satisfy to an acceptable degree. Terrain

reconnaissance also includes the effect of weather on the military aspects of the terrain. Typical engineer focus includes obstacle information, route classification, and gap-crossing sites.

- **Threat.** Threats may include conventional and known enemy forces, insurgents, paramilitary forces, guerrillas, criminal groups, and even civilian groups and individuals.
- **Society (social/human demographics).** Gaining an awareness of how the local society affects military operations and the impact of military operations on the society may be critical to the commander when making operational decisions.

Tempo

2-8. The tempo of the reconnaissance allows the commander to correlate time requirements for the reconnaissance with other factors (planning time, movement formations, dismounted or mounted operational methods). The commander establishes the tempo by answering several questions, to include—

- Given the available time, will ERT need to conduct stealthy or forceful reconnaissance?
- Is the reconnaissance mission deliberate or rapid?

2-9. The following describes the reconnaissance tempo:

- **Stealthy reconnaissance.** Stealthy reconnaissance entails methodical, time-consuming details that minimize chance enemy contact. It is conducted predominantly dismounted, although mounted reconnaissance may also be involved.
- **Forceful reconnaissance.** Forceful reconnaissance is the opposite of stealthy. It is a much faster paced reconnaissance; reconnaissance units are less concerned about being detected by the enemy.
- **Deliberate reconnaissance.** Deliberate reconnaissance entails slow, detailed, broad-based missions in which the reconnaissance element accomplishes several tasks.
- **Hasty reconnaissance.** Hasty reconnaissance is the opposite of deliberate. It focuses the reconnaissance element on a few key pieces of information required by the commander.

2-10. The terminology describing the tempo of reconnaissance is not as important as the requirement that the commanders and their subordinates talk the same language when determining what type of tempo to adopt and how that looks in the AO. Although the ERT may not receive specifically worded reconnaissance guidance from the commander, the ERT leader must analyze requirements for tempo based on the commander's guidance, warning orders, and their experience.

Engagement Criteria

2-11. Engagement criteria establish which targets the reconnaissance element is expected to engage with direct or indirect fires and which targets they are expected to handover to the BCT/RCT maneuver battalions. In general, engagement criteria will apply only to ERTs directly augmenting reconnaissance elements.

2-12. Engagement criteria may be articulated in terms of the type and number of threat systems that a reconnaissance unit may be required to engage (or are prohibited from engaging). They may describe situations in which engagement will or will not occur. They may even address what types of friendly weapon systems may be employed or prohibited. Engagement criteria are linked closely with established rules of engagement; however, they define important deviations from the rules of engagement as opposed to being merely a reiteration of them.

2-13. Engagement criteria may also pertain to how the element handles nonlethal contact (such as tactical questioning of civilians or factional leaders). Additionally, engagement criteria allow the reconnaissance element to anticipate bypass criteria and to develop a plan to maintain visual contact with bypassed or bypassing threat elements.

FORMS

2-14. There are five forms of reconnaissance—

- Route.
- Zone.
- Area.

- Reconnaissance in force.
- Special.

2-15. These forms of reconnaissance will normally be conducted with a multidimensional focus that includes such factors as infrastructure, terrain, threat, and society. (See FM 3-90-2 for additional information on reconnaissance in force and forms of reconnaissance.)

Note. A route reconnaissance is included in the forms of reconnaissance. It should not be confused with a route classification (can be included as part of the route reconnaissance) or a road reconnaissance (a technical component of the route classification).

Route Reconnaissance

2-16. Route reconnaissance is the directed effort to obtain information (focused on the threat or terrain based on the commander's reconnaissance focus) along a specified route and on adjacent terrain (including lateral routes) from which movement along the route could be negatively influenced. The route is a prescribed course from a point of origin (start point [SP]) to a specific destination (release point [RP]). The route could be a road or an axis of advance. Route reconnaissance is conducted to determine whether the route is clear of obstacles or threat forces and how well or poorly it will support the planned movement. Below the BCT/RCT level, route reconnaissance is often a task performed during zone or area reconnaissance as a combined arms mission.

2-17. A route reconnaissance may be assigned as a separate mission or as a specified task for a unit conducting zone or area reconnaissance. Reconnaissance platoons can reconnoiter only one route at a time; therefore, the number of reconnaissance platoons available directly influences the number of routes that can be covered at one time. Integrating ground, air, and other technical assets assures a faster and more detailed route reconnaissance.

2-18. Reconnaissance elements will reconnoiter the route out to the direct-fire range of the threat, focusing on key terrain that threat elements can use to influence the route. Determining trafficability of a route requires the reconnaissance element to determine the capability or extent to which the terrain will bear traffic or permit continued movement of a force. A thorough ground reconnaissance is required for developing detailed information on the route. Modern roadway features are often difficult to evaluate quickly in the process of route reconnaissance. Unless directed, the reconnaissance element does not conduct a deliberate route classification. In some cases, the reconnaissance element may be reinforced with an ERT to perform that mission. In other cases, the element may identify key features for follow-on engineer units to classify or to clear. If enemy contact is expected, fire support should be readily available. If CBRN contamination is expected, CBRN reconnaissance assets should accompany the force conducting ground reconnaissance. When time is limited, air reconnaissance (manned and unmanned) can be used to cue ground reconnaissance elements on where to focus their efforts.

2-19. Control measures for a route reconnaissance create focus. (See figure 2-1.) The commander places lateral boundaries on both sides of the route. These boundaries are far enough out to allow the reconnaissance of all terrain from which the threat could dominate the route. An LD that is perpendicular to the route is placed short of the SP. This allows adequate space for the unit conducting the reconnaissance to deploy into formation before reaching the SP. The LD creates one of the boundaries of the AO. A limit of advance (LOA) is placed far enough beyond the route RP to include terrain from which the threat could dominate the route. Normally, coordination points or contact points are included to enable proper flank coordination. If air reconnaissance is employed, an air LOA is normally established to provide greater depth and to take advantage of the aircraft elevated observation platform and long-range acquisition capability. The SP and RP define that section of the route on which the unit collects detailed information. Phase lines and checkpoints are added to maintain coordinated reconnaissance, to control movement, or to designate critical points. Additional fire distribution measures and fire support coordination measures are included to coordinate indirect and direct fires, as necessary. All of these graphic control measures are placed along or on recognizable terrain features and, if possible, are identifiable from the ground and the air to assist in air-ground coordination.

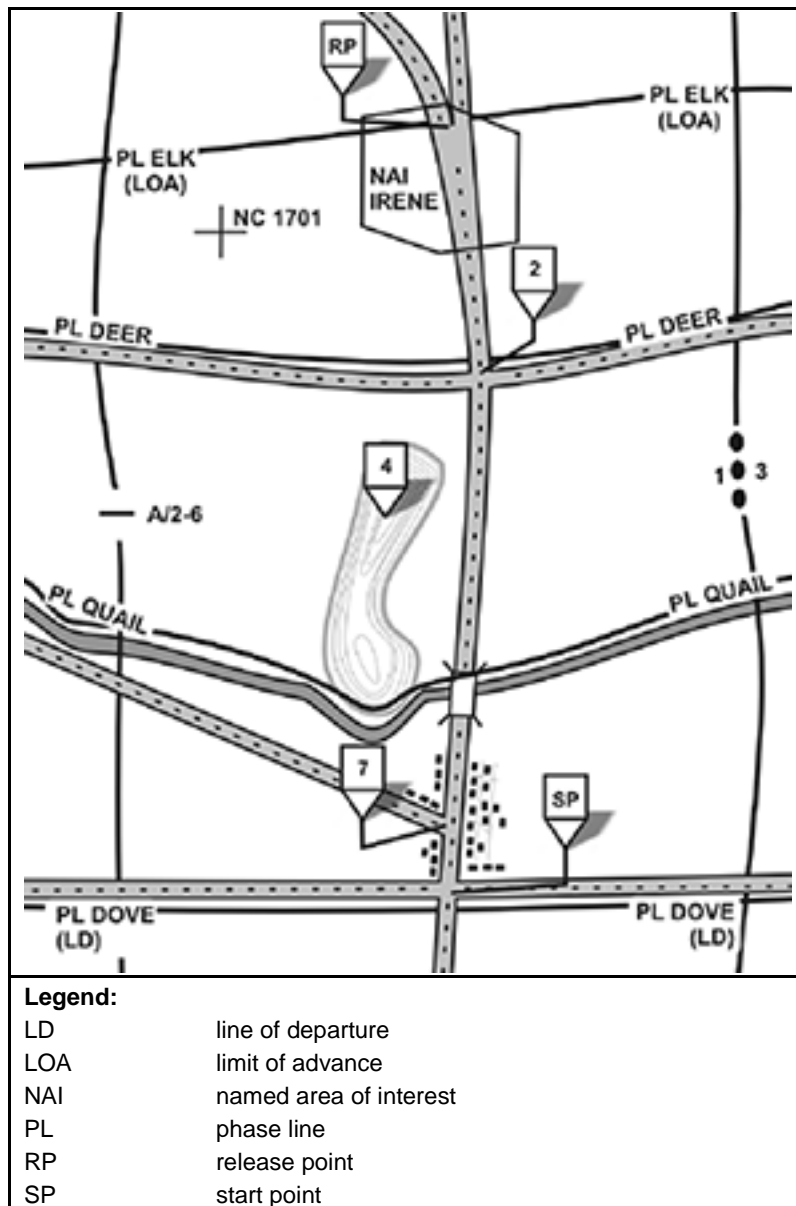

Figure 2-1. Route reconnaissance graphic control measures

2-20. Certain tasks are accomplished during route reconnaissance unless the commander specifically directs otherwise. Tasks may include the following:

- Reconnoiter and determine trafficability of the route.
- Find and report threat elements that can influence movement along the route.
- Reconnoiter routes approaching and inside urban areas.
- Reconnoiter lateral routes.
- Inspect and classify bridges and roads along the route.
- Inspect overpasses, underpasses, tunnels, and culverts.
- Reconnoiter defiles along the route.
- Locate obstacles and other restrictions to mobility along the route.

- Locate bypasses around built-up areas, obstacles, and contaminated areas.
- Update route information.

Zone Reconnaissance

2-21. Zone reconnaissance is the directed effort to obtain detailed information concerning threat, terrain, society, and infrastructure according to the commander's reconnaissance focus within a location delineated by LD, lateral boundaries, and LOA. A zone reconnaissance is assigned when the threat situation is vague or when information concerning cross-country trafficability is desired. It is appropriate when previous knowledge of the terrain is limited or when combat operations have altered the terrain. Critical terrain features or points of interest are designated as checkpoints. The reconnaissance may be threat-oriented, terrain-oriented, society-oriented, infrastructure-oriented, or a combination. Additionally, the commander may focus the reconnaissance effort on a specific force (such as the threat reserve). A terrain-focused zone reconnaissance must include the identification of obstacles (existing and reinforcing) and areas of CBRN contamination.

2-22. Zone reconnaissance takes more time to execute than other reconnaissance missions do because the target area is larger and the information requirements usually generate many unanswered questions. If the time available is not adequate, the reconnaissance leader seeks additional time, reinforcements, or systems to assist in the reconnaissance effort. If necessary, the reconnaissance leader may accelerate the reconnaissance effort and accept a degree of risk by reducing the number of critical tasks to be accomplished.

2-23. A zone reconnaissance is organized with subordinate elements operating abreast of one another within a portion of the zone as designated by graphic control measures. (See figure 2-2.) Fire support coordination measures are included, as needed. If the BCT/RCT commander expects significant threat forces to be found within the zone, consider attaching armored, mechanized, or aviation forces to the reconnaissance element to deal with the anticipated threat. If it is likely that the reconnaissance elements will encounter significant obstacles or other mobility impediments, the commander may provide combat engineer augmentation. If the zone reconnaissance will be outside the supporting range of the BCT/RCT, additional fire support elements may be task-organized to move with the reconnaissance element.

2-24. Zone reconnaissance is a deliberate, time-consuming process; therefore, it must be focused. The reconnaissance force must accomplish certain critical tasks unless the BCT/RCT commander specifically directs otherwise. The tasks associated with zone reconnaissance include:

- **Threat.** Find and report threat forces within the zone.
- **Society.**
 - Determine the size, location, composition of the populace within the zone and applicable social demographics.
 - Establish and maintain contact with local civilian and military leadership.
- **Infrastructure.**
 - Identify critical infrastructure that can affect military operations.
 - Inspect and evaluate lines of communication.
 - Locate and determine the extent of the engineer resources (soil, gravel, lumber) available within the zone.
- **Terrain.**
 - Locate obstacles; neutralize or mark lanes as specified in the operation order.
 - Locate and determine the extent of contaminated areas, including CBRN.
 - Reconnoiter and determine trafficability, including urban areas.
 - Locate bypasses around urban areas, obstacles, and contaminated areas.
 - Provide obstacle information and recommendations for breaching or bypassing.
 - Locate fords or crossing sites near bridges within the zone.

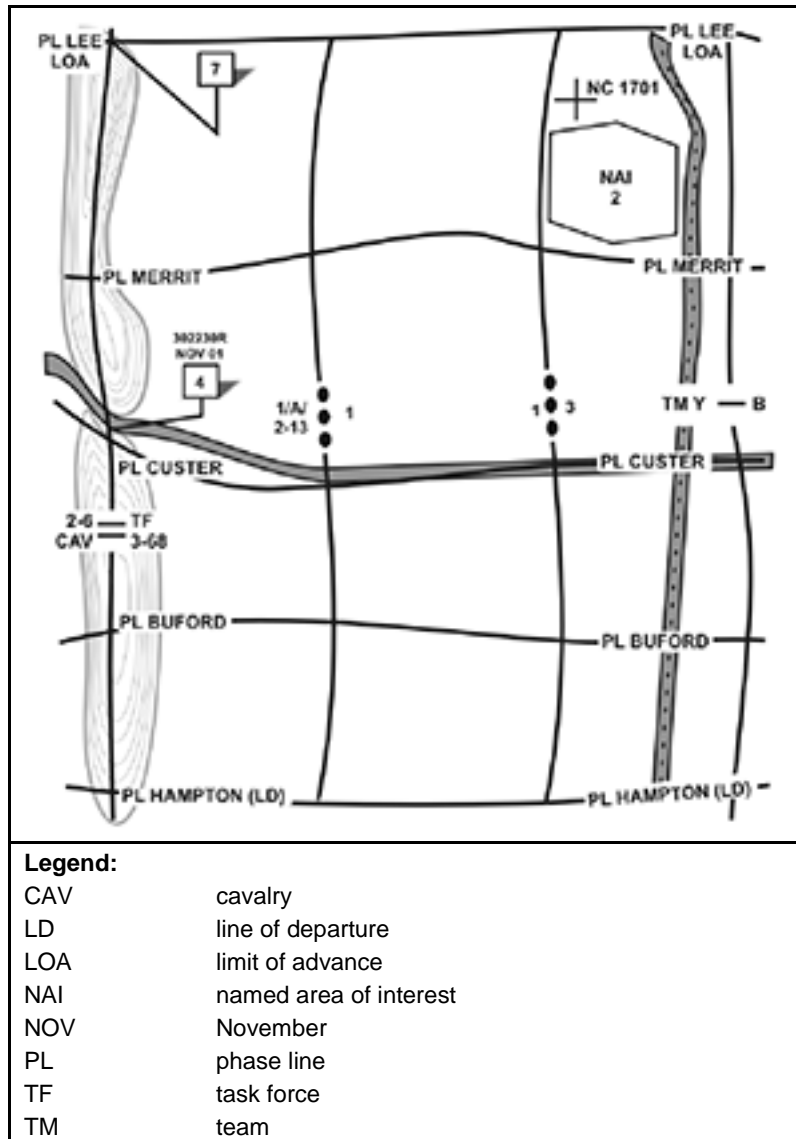

Figure 2-2. Zone reconnaissance graphic control measures

Area Reconnaissance

2-25. An area reconnaissance is a directed effort to obtain detailed information concerning threat, terrain, society, and infrastructure according to the commander's reconnaissance focus for a prescribed area. The tasks accomplished as part of an area reconnaissance are the same as those for a zone reconnaissance, only the scale of the reconnaissance is different. The objective in an area reconnaissance is substantially smaller than the terrain reconnoitered in a zone reconnaissance. These objectives may be a small village or town, critical infrastructure (water treatment plants, weapon storage sites, political headquarters), or other sites of tactical importance (a suspected assembly area, a cache site, an airport). The reconnaissance element in the BCT/RCT can conduct decentralized reconnaissance in multiple areas simultaneously, by maneuvering elements through the areas or by establishing stationary observation posts within or external to them.

2-26. Forces conducting an area reconnaissance are organized according to the size, geography, physical infrastructure, and social dynamics of the area to be reconnoitered and the time available for conducting the reconnaissance. The forces may be required to reconnoiter one large area or several smaller ones. In many cases, areas to be reconnoitered are assigned to platoon-size teams. A company- or troop-size team may be

committed to a larger area. Focused reconnaissance capabilities (engineer, CBRN) may augment one or more of the primary reconnaissance elements, as required and available. Area reconnaissance proceeds faster than zone reconnaissance because the effort is focused on a relatively smaller, specific piece of terrain or threat force.

2-27. The area for an area reconnaissance is delineated with a single continuous line enclosing the area to be reconnoitered, and the area should be designated as an AO. If the AO is a large or complex urban area, it may also be delineated by marking lateral boundaries, LD, and LOA (similar to a zone reconnaissance). The graphic control measures for an area reconnaissance should always include the routes to and within the AO. (See figure 2-3.)

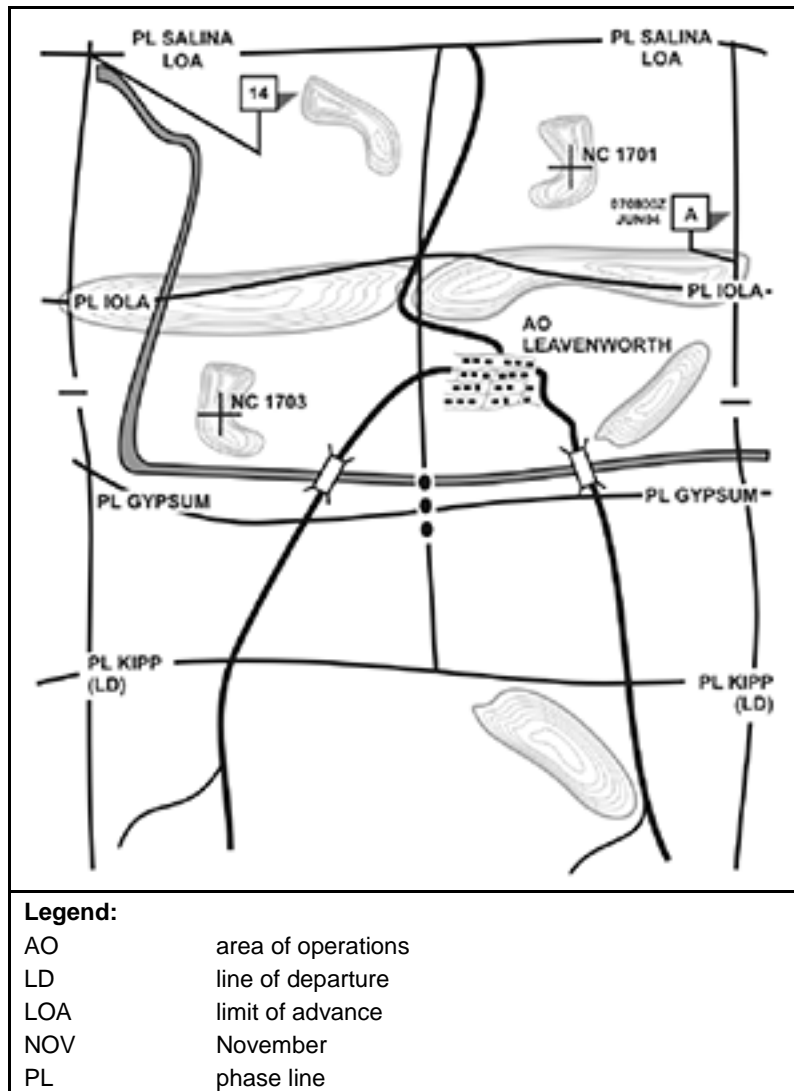

Figure 2-3. Area reconnaissance graphic control measures

Chapter 3

Reconnaissance Support

Reconnaissance support is guided by the same overall mission of the reconnaissance element. ERTs take the basic form of a route, area, or zone reconnaissance and use techniques that are compatible with the supported force. ERTs conduct zone, area, and route reconnaissance with a reconnaissance focus linked directly to answering the information requirements, but with a specified additional focus on the required technical information. This chapter focuses on reconnaissance support to of the five functions of mobility, support of obstacle integration and turnover in countermobility, support to fighting and other protective positions, and support to other tactical missions performed by the BCT/RCT.

SUPPORT TO MOBILITY

3-1. Mobility is essential to achieving decisive results across the range of military operations. The operational environment will present numerous challenges to movement and maneuver. These are typically overcome through the integration of mobility and countermobility in support of mission requirements. Reconnaissance facilitates mobility through the following tasks:

- Conduct breaching.
- Conduct clearing (areas and routes).
- Conduct gap crossing.
- Construct and maintain combat roads and trails.
- Construct and maintain forward airfields and landing zones.
- Conduct traffic management and enforcement. (See ATP 3-39.10 for traffic management and enforcement.)

3-2. The primary focus of the ERT is collecting technical information in support of mobility. This can include—

- Conducting route, zone, or area reconnaissance to determine trafficability.
- Detecting the location and boundaries of obstacles.

OBSTACLE RECONNAISSANCE

3-3. Where enemy obstacles can interfere with friendly maneuver, obstacle information is one of the information requirements that should become a priority intelligence requirement. Finding enemy obstacles or observing enemy activity to construct reinforcing obstacles validates and refines the S-2 picture of the AO. Obstacle information helps the S-2 to determine enemy intentions, plans, and defense strength. The engineer staff is the unit expert on enemy countermobility capabilities and assists the S-2 in templating enemy obstacles, analyzing obstacle information, and analyzing the effects of the terrain. The S-2, S-3, and engineer staff establish an obstacle information collection plan by determining specific obstacle information requirements. Obtaining obstacle information requires dedicated collection assets. Reconnaissance assets are tasked to collect specific information that is needed to fulfill obstacle information requirements.

3-4. Obstacle reconnaissance is one of the high-frequency tasks conducted by ERTs. The task is to conduct reconnaissance of obstacles focused on answering obstacle information requirements. These requirements include—

- Obstacle location, length, width, and depth.
- Obstacle composition (wire, mines by type).

- Soil conditions.
- Lane and bypass locations.
- Enemy direct-fire systems locations.

3-5. An ERT moves with scouts or a patrol to conduct dismounted reconnaissance of locations that contain confirmed or doctrinally templated obstacles. The purpose of the reconnaissance is to locate the obstacle and determine how best to overcome the effects of the obstacle (reduction or bypass). The following tasks may be associated with the reconnaissance:

- Locating and marking a bypass.
- Locating and marking the best location to reduce.
- Estimating the reduction assets necessary to reduce the obstacle.

3-6. Although an ERT may have a limited capability to clear or reduce small obstacles that are not covered by fire or observation, ERTs engaged in a reconnaissance mission and tasked to collect obstacle information are generally not used to reduce obstacles during the reconnaissance mission. Inadvertent detonation during reduction may compromise engineers and scouts, defeating the reconnaissance mission. It may also compromise the entire attack. If a decision is made to breach an obstacle, the ERT can typically provide guides to the breach forces for subsequent breaching.

3-7. The ERT approaches a known or suspected obstacle location with caution. Security is established, with support from the tactical reconnaissance element if possible, and selected engineer personnel conduct dismounted movement to the obstacle. Trip wires and other wires may indicate that the enemy is using booby traps or command-detonated mines to prevent friendly forces from collecting information on the obstacle. The ERT prepares an obstacle report with the relevant information. Examples of obstacle information collected through obstacle reconnaissance include the—

- Location of existing and reinforcing obstacles.
- Orientation and depth of obstacles.
- Conditions of the soil (in the case of a minefield) to determine the ability to use mine plows.
- Presence, location, and type of wire.
- Location of lanes and bypasses.
- Composition of explosive hazards, including minefields (buried or surface-laid antivehicle and antipersonnel mines, antihandling devices, and the depth of the buried mines).
- Types of mines and fuses; composition of the minefield.
- Location of enemy indirect-fire systems that can fire into the breach area.
- Composition of complex obstacles.
- Areas between successive obstacle belts.

3-8. The ERT forwards an obstacle report to the supported unit main command post and its parent unit when possible. In the digital environment, information requirements remain the same; however, the means by which the ERT collects data and retransmits it back to the maneuver main command post has changed. Information obtained about the terrain, terrain features, and obstacles can now be digitally transmitted to the maneuver main command post to facilitate BCT/RCT force mobility. Information collected can be digitally transmitted in near real or real time.

3-9. After collecting the information, the scout platoon or ERT leader analyzes the situation and the mission variables to select a course of action. Once the scouts and ERTs have determined the best course of action for a situation, they execute it or recommend it to higher headquarters for approval. Generally, the reconnaissance team executes a particular course of action without specific approval if it is addressed in the operation order received from higher headquarters or if it is in the unit standard operating procedure (SOP). If the situation encountered is not covered by previous guidance, the reconnaissance team determines the best course of action and recommends it to the commander before execution. The four courses of action are—

- Use a bypass.
- Neutralize the obstacle.
- Support a breach.
- Continue the mission.

3-10. Using a bypass is the preferred method when it offers a quick, easy, and tactically sound means of avoiding the obstacle and a likely enemy engagement area. A good bypass must allow an entire force to avoid the primary obstacle without risking further exposure to enemy fire and without diverting the force from the objective. Bypassing conserves reduction assets and maintains the momentum. If a reconnaissance team locates a bypass and the commander approves its use, scouts and engineers must mark it according to the supported unit tactical SOP and report its location to the commander. At a minimum, this report should include the grid location to the far recognition marker and information on how the obstacle is marked to confirm that the bypass is marked according to the SOP. If the reconnaissance team is tasked to mark a bypass, the team must emplace markers so that they are not visible to the enemy. Engineers and scouts may be required to provide guides for the main body, especially if the bypass is difficult to locate or if visibility conditions are poor.

3-11. Bypassing is not always possible; breaching may be the best or only solution. The following situations are examples:

- The obstacle is integrated into a prepared defensive position, and the only available bypass moves friendly forces into an ambush.
- The reconnaissance mission specifically tasks the reconnaissance team to clear the original route for follow-on forces.
- The best available bypass route does not allow follow-on forces to maintain the desired rate of movement or it diverts the force from the objective.
- Improvements to the bypass may require more time and assets than breaching the primary obstacles.

3-12. Reducing an obstacle significantly degrades the ability to maintain the momentum of the reconnaissance or follow-on forces. Obstacles that the scout and ERT are able to reduce include small surface laid minefields, simple wire obstacles, small roadblocks, and similar obstacles. The supported commander should make the decision to have the reconnaissance team reduce an obstacle while considering the risk to the reconnaissance team and the potential for prematurely identifying the route for use by friendly forces during an impending attack. Obstacle reduction should not be attempted if the obstacle is part of an integrated defensive position.

3-13. When a large obstacle is located and cannot be bypassed easily, the alternative is to support a breach. Scouts and engineers perform additional reconnaissance tasks in support of breaching. These tasks include determining the assets and time needed to reduce the obstacle and determining the best location for the reduction site. Scout and engineer reconnaissance efforts focus on the following:

- Trafficable routes to the reduction site and routes from the far side leading to the objective.
- Proposed locations for positioning the support force.
- Dispersed, covered, and concealed areas near the reduction site.
- Best location for the reduction effort at the obstacle. It is imperative that the reduction plan be sent to the reconnaissance teams once the scheme of maneuver is finalized. Information (number of lanes required, distance between lanes) is needed for the reconnaissance forces to conduct the necessary reconnaissance.
- Positions on both sides of the obstacle that could provide enemy observation of the reduction site.
- Trafficability and soil conditions near the reduction site. This is especially important for minefield reduction because mine-clearing blades will not work effectively in all soil conditions.
- Soil type (loamy, rocky, sandy).
- Width, depth, and bottom conditions of wet and dry gaps and fords.
- Bank height and slope and the soil stability of wet and dry gaps.
- Water velocity and the direction of flow of wet gaps and fords.
- Wind direction for using smoke to obscure enemy vision.
- Location of the forward edge of the minefield to support mine-clearing line charge use.

CLEARING

3-14. Clearing is conducted to neutralize explosive hazards and other obstacles from a route or area. As with most mobility support activities, clearing is often conducted by a combined arms organization built around an engineer-based clearing force.

3-15. Each clearing team will produce a comprehensive, detailed report that identifies the location of the obstacles encountered and cleared. (See ATTP 3-90.4/MCWP 3-17.8 for more information on reporting cleared obstacles.)

GAP CROSSING

3-16. Ground combat formations engaged in offensive and defensive operations must be able to cross wet or dry gaps in existing road networks or natural high-speed avenues of approach. Very few lines of communications will exist without some form of bridge, bypass, or detour. Maneuver forces and logistical support depend on three types of bridging—

- Tactical.
- Support.
- Line of communications.

3-17. Combined arms operations conducted by ground combat forces (BCT/RCT) primarily focus on seizing and exploiting available bridges (existing or permanent) or employing tactical and support bridges. Tactical bridging is typically linked to combat engineer units that provide close, immediate support of combined arms ground maneuver. (See ATTP 3-90.4/MCWP 3-17.8 for on additional information on bridging as a component of combined arms gap crossing.)

3-18. Engineer units support gap crossing through construction, repair, and reinforcement of bridges; by providing bridge reconnaissance and classification; and by the construction of bypasses and detours. The specific mission undertaken is planned in a manner that maintains the momentum of the force. Bypasses and fording sites can be used to overcome obstacles when it is more feasible or when bridges are not available. Existing bridges may need to be repaired or reinforced to keep main supply routes and lines of communications open. As the tactical situation changes, main supply routes are moved or improved to support the force. Forward elements may demand that organic tactical bridges be replaced by more permanent line of communications bridges and those tactical bridging assets be returned to continue the attack. Tactical bridges are also not designed for the long duration use that are typical for main supply routes and will need to be replaced by line of communication bridges. Requirements for engineer units to employ tactical, support, and line of communications bridging continue throughout the fight.

3-19. Engineer unit planners use geospatial products and support to improve situational understanding (to include terrain) and select optimal bridging sites. Geospatial products helpful for planning can include high-resolution satellite imagery and UAS video pictures of terrain. Geospatial specialists employ software to assist mission planning by determining soil conditions, hydrology, vegetation types, general weather patterns, and other useful aspects of the terrain. This allows planners to determine conditions in areas at or adjacent to potential gap-crossing sites and develop more detailed plans.

3-20. During the performance of route and area reconnaissance, ERTs focus on existing structures (including bridges) while gathering information on trafficability. The ERTs inspect each bridge to determine its load-carrying capacity (classification) and assess its structural integrity. The ERTs determine whether the situation warrants emplacing tactical, support, or line of communications bridge assets. When a damaged bridge requires replacement, ERT reporting provides information regarding the serviceability of the in-place structural members and availability of local materials that may be reused in other construction. To maximize the effectiveness (capacity) of available tactical, support, and line of communications bridge assets, engineer units will use existing roads, abutments, piers, and spans if they are serviceable. Additional information related to bridge classification, technical assessment, and reporting can be found in appendix D, appendix C, and appendix B.

3-21. Bridge reconnaissance is classified as hasty or deliberate, depending on the amount of detail required, time available, and security in the AO. ERTs typically conduct the hasty reconnaissance while augmented ERTs, assessment, or survey teams are tasked to conduct the deliberate reconnaissance. A deliberate

reconnaissance is usually conducted in support of main supply routes and lines of communications bridging since greater traffic requirements dictate that time and reachback to certified professional engineers (U.S. Army Corps of Engineers, Naval Facilities Engineering Command) be made available to support the task. An engineer light dive team can assist with the deliberate reconnaissance by providing near shore and far shore crossing site data. Additionally, they can mark and prepare landing sites, riverbanks, and exit routes for the crossing force. A deliberate reconnaissance includes a thorough structural analysis; a report on approaches to the bridge site; a report on the nature of the crossing site, abutments, intermediate supports, and bridge structure; repair and demolition information; and the possibility of alternate crossing sites.

3-22. When structures are inadequate or do not exist, ERTs conduct area reconnaissance to collect data that identifies terrain that is more suitable or conditions more favorable for new construction. ERTs use the assessment tools and procedures to provide the required technical focus for other gap-crossing sites. Using the results of reconnaissance, planners can determine which type of bridge or bridge combinations are right for the mission based on available resources. The location ultimately chosen for the bridge is determined by numerous factors that are reflected in its structural design. Primary screening considerations include—

- **Access and approach roads.** Determine if the preexisting roads are adequate. The time to construct approaches can be a controlling factor in determining if a crossing site is feasible. Approaches should be straight, with two lanes, and less than a 6-percent slope.
- **Width.** Determine the width of the gap to be spanned at normal and flood stage for wet gaps.
- **Banks.** Estimate the character and shape of the banks accurately enough to establish abutment positions. The banks should be firm and level to limit the need for extensive grading. Select straight reaches to avoid scour.
- **Flow characteristics.** Determine the stream velocity and erosion data, taking into consideration the rise and fall of the water. A good site has steady current that runs parallel to the bank at less than 3 feet per second.
- **Stream bottom.** Record the characteristics of the bottom. This will help in determining the type of supports and footings required. An actual soil sample is useful in the planning process, particularly in wide gaps that may require an intermediate pier.
- **Elevation.** Determine and record accurate cross-section dimensions of the site for determining the bridge height. Planners must also know of existing structures that the bridge must cross over.
- **Materials.** Determine the accessibility of material for improving bank conditions (rock, gravel, and other expedient construction materials).

COMBAT ROADS AND TRAILS

3-23. The maneuver commander may require that a new or upgraded route be constructed to facilitate mobility and support a scheme of maneuver or movement within an AO. An entirely new section of road may need to be constructed, for example, to bypass a known obstacle (natural or man-made). This may include the bypass of a densely populated location. The maneuver commander may also order an unusable road upgraded or a trail created to permit the passage of forces. This combat construction could be a stand-alone mission to open or reopen a necessary route, or it may be part of a larger mobility (a river crossing that may require access and egress roads). Construction and maintenance of combat roads and trails is a tactical task to enhance maneuver. Road improvements executed by horizontal construction units to improve lines of communications are typically characterized as general engineering. Combat roads and trails include a requirement for a combination of route and area reconnaissance to gather the required technical information.

3-24. Thorough reconnaissance is essential in the selection of combat roads or trails. It normally starts with a study of available maps and aerial photos. Aerial reconnaissance provides valuable information; however, detailed information is only obtained by ground reconnaissance.

3-25. The types of reconnaissance and applicability to combat roads and trails include—

- **Route reconnaissance.** A route reconnaissance is one of the three forms of tactical reconnaissance. It should not be confused with a route classification, which can be included as part of the route reconnaissance or a road reconnaissance (a technical component of the route classification).
- **Route classification.** A route classification is assigned to a route using the conditions of minimum width and worst route type; lowest MLC for bridge, raft, or culvert; and obstructions to traffic flow. Executing a route classification is executed as hasty or deliberate. Reconnaissance collects information about roads, bridges, tunnels, fords, waterways, and other natural terrain features that may affect the desired traffic flow. Information obtained in a hasty route classification may be adequately recorded on a simple sketch or overlay. An overlay is produced. The overlay is accompanied by forms that describe the route, its components, and pertinent terrain features in detail using specifically designed report formats found in appendix B.
- **Road reconnaissance.** ERTs conduct road reconnaissance as a component of route classification, while assessment teams conduct road reconnaissance as the primary focus of technical reconnaissance support. The ERTs are primarily interested in the road as it affects route trafficability. The assessment team is interested in the engineering details of the road to support its upgrade or repair. Road reconnaissance is defined on DD Form 3010, *Road Reconnaissance Report*, and it is included in appendix B.
- **Area reconnaissance.** New road construction is avoided when possible to save time and labor. When a new road is necessary, the first step is area reconnaissance. This requires a specific type of area reconnaissance in which all possible route layouts are included to ensure selection of the best route. Its main objective is to locate a new road or trail in an area that will hold up under anticipated traffic and meets mission requirements.

3-26. ERTs conduct route reconnaissance to determine trafficability of the selected route and its components. Typically, a route classification is included as a specified task for the ERT as part of an assigned route reconnaissance. The route classification describes the traffic-bearing capabilities and condition of the selected route and supports the decisions on the improvements needed before a route can carry the proposed traffic. The way in which route reconnaissance is performed depends on the amount of detail required, the time available, the terrain problems encountered, and the tactical situation. Hasty route classification determines the immediate military trafficability of a specified route. It is limited to critical terrain data necessary for route classification. The results are part of the mobility input to the common operational picture. Information concerning the route is updated with additional reports as required by the situation and the commander's guidance. A deliberate route classification (including road, bridge, tunnel, and other technical components) is conducted when sufficient time and qualified technical personnel are available. Deliberate route classification is usually conducted when operational requirements are anticipated to cause heavy, protracted use of the road and may follow the conduct of a hasty route reconnaissance.

3-27. The ERT is briefed as to the anticipated traffic (wheeled, tracked, or a combination) and the anticipated traffic flow. Single flow traffic allows a column of vehicles to proceed while individual oncoming or overtaking vehicles pass at predetermined points. Double flow traffic allows two columns of vehicles to proceed simultaneously in the same or in opposite directions. The ERT may also be asked to determine the grade, alignment, horizontal and vertical curve characteristics, and the nature and location of obstructions. Obstructions are defined as anything that reduces the road classification below what is required to support the proposed traffic efficiently. Obstructions include—

- Restricted lateral clearance, including traveled way width (bridges, built-up areas, rock falls, slide areas, tunnels, wooded areas).
- Restricted overhead clearance (overpasses, bridges, tunnels, wooded areas, built-up areas).
- Sharp curves.
- Excessive gradients.
- Poor drainage.
- Snow blockage.
- Unstable foundation.
- Rough surface conditions.

3-28. Other obstacles include CBRN contamination, roadblocks, craters, explosive hazards, cultural sites, and environmental restrictions. Existing bridge condition requires special attention as they may be deteriorated and be the limited factor of a route. Reachback may be necessary for correct classification of existing bridges. It may be necessary to conduct a bridge reconnaissance and classification computations.

3-29. Information collected can be digitally transmitted in near real or real time via the digital reconnaissance system. When available, an automated route reconnaissance kit (ARRK) can provide engineer units with an automated reconnaissance package that allows the reconnaissance element to collect and process reconnaissance information. Use of the ARRK assists the ERT by tracking location, speed, curve, and slope of roads and obstacles encountered along the route. The ARRK is described in detail in appendix E.

3-30. ERTs conduct area reconnaissance when shortfalls are identified and the need to move or maneuver cannot be supported by the existing road or trail network. With their understanding of force mobility requirements in the forward area, the ERT can quickly evaluate the terrain for possible cross-country movement. The ERT can also evaluate and collect preliminary information on sites that may be suitable for construction of combat roads and trails. Typically, the decision to construct combat roads or trails can be made with the technical information collected in the area reconnaissance. In the event that a new, more durable road (semipermanent) is required, an assessment or survey team will typically conduct specific site investigations to collect the detailed technical information required for planning a road network. Site investigation requires a thorough knowledge of soils engineering, hydrology, and technical design requirements. A detailed site investigation will serve as the foundation behind the design of a new road and the upgrade, repair, and maintenance of an existing road.

3-31. Periodic reconnaissance is especially important when conducting missions in regions subject to extremes that may have a detrimental effect on combat roads and trails. During winter months in cold environments, this includes the possibility of snow roads for off-route traffic or ice roads across lakes and streams. Maintenance requirements based on periodic reconnaissance (to include basic snow removal) must be coordinated with the units using the roads. This ensures that the engineer maintenance effort will not be spent on roads that are no longer needed and that engineer crews will not interfere with the movement of critical convoys.

FORWARD AVIATION COMBAT ENGINEERING

3-32. To accomplish the mission and meet the operational requirements of the combined arms team, airfields and heliports are seized and improved or tactical (expedient) facilities are constructed and maintained when similar facilities do not exist or they are unavailable or unsuitable. Forward aviation combat engineering (FACE) prepares or repairs landing zones, forward arming and refueling points, landing strips, or other aviation support sites in the forward combat area. All other airfield and heliport construction is considered general engineering tasks. (See ATTP 3-90.4/MCWP 3-17.8.)

3-33. Airfields and heliports are classified by the degree of permanence, type, and quantity of aircraft they are designed to support. The design of airfields and heliports accommodates performance characteristics for each supported aircraft. It also addresses the need to safely control aircraft movement while on airfield surfaces and during arrivals and departures. This is especially important when different types of aircraft (fixed wing, rotary wing, tilt rotor) must operate from the same airfield. To incorporate this operational consideration, airfields and heliports are divided into different classes. Each class is matched to a single or multiple types of controlling aircraft. Airfield classification criteria and types are listed in UFC 3-260-01. A controlling aircraft or combination of controlling aircraft has been designated for each category to establish limiting airfield, geometric, and surface strength requirements.

3-34. A bare base airfield is a site with a usable runway, taxiway, parking area, and source of water that can be made potable. It must be capable of supporting assigned aircraft and providing other mission-essential resources (such as logistical support and services infrastructure composed of people, facilities, equipment, and supplies). Depending on the level of airfield services and condition of infrastructure available at a bare base airfield, additional modular, mobile facilities, utilities, and support equipment packages may be deployed and rapidly installed.

3-35. The ERT conducts area reconnaissance to collect the technical information required to support FACE. This information can also provide the preliminary level information for planning follow-on assessments,

general engineering airfield support, and a survey if necessary. The ERT focuses on collecting the minimum information required for the intended use of the facility. The ERT employs the appropriate components of the full airfield assessment to understand the information required by the FACE mission. Additional technical expertise can augment the ERT when the information required exceeds the ERT organic level of expertise. The focus of reconnaissance in support of FACE may include the following:

- Site drainage system structure.
- Design and condition of runways, taxiways, and hardstands.
- Availability of soils and other materials and their usefulness for improving subgrade.
- Type and thickness of the base course.
- Type and thickness of the surface course.
- Information on related facilities (access and service roads; ammunition and petroleum, oils, and lubricants storage areas; navigation aids; maintenance aprons; warm-up aprons; corrosion control facilities; control towers; airfield lighting; security fencing).
- Environmental considerations, to include applicable force health protection intelligence.

SUPPORT TO COUNTERMOBILITY

3-36. Countermobility involves constructing reinforcing obstacles integrated with fires to inhibit the maneuver of an enemy force, increase the time for target acquisition, and increase the effectiveness of friendly force weapons. Commanders apply countermobility considerations throughout the planning process. They are integrated within the concept of operations, fire support planning, and scheme of maneuver. An ERT can be employed to conduct route and area reconnaissance to confirm the significance of existing natural obstacles and guide site selection for emplacement of reinforcing obstacles. Other countermobility planning factors to be considered include obstacle turnover, protection, and tracking. (See ATP 3-90.8/MCWP 3-17.5 for additional information on combined arms countermobility.)

OBSTACLE PLACEMENT

3-37. Terrain analysis is used to identify areas suitable for obstacles. Area reconnaissance is used to determine the exact location of individual obstacles based on the enemy force (target), desired location of massed fires, tentative weapon system positions, and the intended effect (disrupt, fix, turn, or block). An area reconnaissance is conducted to verify that individual obstacles are covered by fires, note locations of fire control measures and obstacles, and record the appropriate data on range cards. (See ATP 3-90.8/MCWP 3-17.5 for a detailed discussion on obstacle integration and siting of obstacles.)

3-38. Terrain analysis is also used to identify areas suitable for situational obstacles. Reconnaissance is used to determine the best location on the ground for a situational obstacle based on the enemy force (target), desired location of integrated fires, tentative decision point, and the intended effect (disrupt, fix, turn, or block). Area reconnaissance is conducted to verify that selected locations are suitable for scatterable mines or other situational obstacles.

3-39. The integrated obstacle plan may include the use of demolition obstacles with other types of obstacles. Demolition obstacle planning requires detailed technical information to design the demolition attack and estimate the resources necessary. The ERT conducts area reconnaissance to collect specific technical information for planning the demolition of selected targets. The ERT is given the information available on the selected target, and they must understand the demolition objective. This information helps the ERT to determine the best method of destroying the target and to estimate the preparation time required. For example, if the reconnaissance party knows that manpower and time are limited but explosives are plentiful, they may design demolitions that require fewer personnel, less time, and large quantities of explosives. The ERT conducts reconnaissance of the target and collects and reports the following information on DA Form 2203, *Demolition Reconnaissance Record*:

- Target location and nature of the target.
- Proposed demolition classification (reserved or preliminary).
- Preferable firing system type (dual or single).
- Economy of effort (whether the demolition must be completed in one stage or multiple stages).

- Utility of the target during demolition (whether the target must remain open to traffic during demolition preparations).
- Time allowed or expected between preparation and execution of the demolition.
- Time allowed for changing the state of readiness (safe to armed).
- Labor and equipment available for preparing the demolitions.
- Type and quantity of explosives.

MAINTAIN OBSTACLE INTEGRATION

3-40. The ERTs conduct area reconnaissance periodically to ensure emplaced obstacles remain integrated into the scheme of maneuver. The task includes turnover and transfer, protection, repair, and tracking of obstacles. Obstacle protection includes counter-reconnaissance to prevent the enemy from gathering obstacle information and enemy mobility asset destruction to ensure maximum effectiveness of obstacles. Obstacle tracking includes supervising the achievement of key milestones (Class IV and V forward, engagement area development initiated, siting completed, collation and dissemination of obstacle information, maintenance of records) as part of the unit timeline.

SUPPORT TO SURVIVABILITY

3-41. Survivability provides cover and mitigates the effects of enemy weapons on personnel, equipment, and supplies while simultaneously deceiving the enemy regarding the intentions of the force. Survivability ranges from employing camouflage, concealment, and decoys to the hardening of facilities, command and control nodes, and critical infrastructure. Engineers participate in and provide staff advice on—

- Survivability and decoy measures.
- Hardening of facilities to resist the destruction of command and control facilities (as part of integrated plans).
- Air and missile defense weapons systems.
- Support structures within the communications zone.

3-42. Within a missile threat environment, engineers provide field fortification support to harden key assets against missile attacks. Protection includes survivability engineering applications to host nation facilities and U.S.-operated facilities as protective measures for U.S. forces or national interests. Survivability also includes providing concealment and protective shelter from the effects of enemy weapons. The ERT conducts area reconnaissance to collect the technical information required to plan survivability operations. (See ATP 3-37.34/MCWP 3-17.6 for additional information on survivability.)

SUPPORT TO OTHER ENVIRONMENTS AND ACTIVITIES

3-43. The ERTs conduct zone, area, and route reconnaissance with a reconnaissance focus linked directly to answering the commander's critical information requirements, but with a specified additional focus on the required technical information. While the basic principles associated with engineer reconnaissance support is similar in support of M/CM/S, there are specific considerations that apply only to certain other types of operations. This section provides considerations for tactical engineer reconnaissance support to complex terrain, urban terrain, jungle terrain, mountainous terrain, desert terrain, and cold region terrain.

COMPLEX TERRAIN

3-44. The ERTs support tactical reconnaissance in urban terrain with route, area, and zone reconnaissance integrated closely with tactical reconnaissance elements. In urban terrain, the preferred means of employment is to task-organize ERTs directly to maneuver battalion or squadron scouts or cavalry squadron troops to augment those units during tactical reconnaissance operations. Engineers teamed directly with dedicated reconnaissance assets add required technical skills to the team, which can increase the tempo and effectiveness of the reconnaissance mission. The ERT must be familiar with planning considerations unique to the urban environment. This discussion focuses on the following elements of planning for urban reconnaissance:

- Collect and analyze existing intelligence.
- Determine reconnaissance and surveillance objectives. (See FM 3-90-2 and ATTP 3-06.11.)
- Plan infiltration and exfiltration routes.
- Synchronize aerial and ground reconnaissance plans.
- Develop communications and sustainment plans.
- Coordinate for support.
- Continue to improve the urban sketch.

Collect and Analyze Existing Intelligence

3-45. The reconnaissance element conducts collaborative planning with the BCT/RCT. Reconnaissance elements collect information to allow the BCT/RCT commander to gain an understanding of the AO and select the most advantageous course of action. Because of its complex nature, urban terrain requires time for development of situational understanding. Human intelligence and signal intelligence will be major contributors of the required information. However, time requirements for locating sources and corroborating information must be taken into consideration.

3-46. Reconnaissance focuses efforts on collecting information about the urban area that supports the BCT/RCT commander's designated course of action. This information may be directly linked to the commander's critical information requirements or may support triggers established in the course of action (targeting lethal and nonlethal effects).

3-47. The development and dissemination of standardized urban mapping products can enhance the success of urban reconnaissance. Most commonly, these products are based on aerial photographic products from UAS reconnaissance overflights or satellite imagery. Using digital systems, these products can be enhanced with graphic overlays showing unit and element sectors; building numbering systems; and key buildings, sites, and terrain features. The products can then be distributed through hard copy reproduction or digital broadcasting. When tactically and technically feasible, units should gain access to city planner or civil engineer maps, which will provide detailed information on the urban area.

3-48. The urban terrain sketches will include a reference system to identify buildings and streets. Naming conventions should be simple, allowing ease of navigation and orientation in the urban environment (for example, odd-numbered buildings on the left side of streets, even numbers on the right). Street names should not be used as references; signs can be missing or changed to confuse friendly forces. (See appendix F.)

3-49. Units conduct initial map or aerial photograph reconnaissance to pinpoint key terrain and other important locations that can be identified in the AO. These areas include the following:

- Safe havens.
 - Hospitals.
 - Police stations.
 - Embassies.
 - Other (friendly) facilities.
- Hazardous areas.
 - Construction sites.
 - Industrial areas.
 - Dangerous intersections.
 - Bridges.
 - Criminal areas.

- Major terrain features.
 - Historical, cultural, or religious sites.
 - Parks.
 - Airports and train stations.

Plan Infiltration and Exfiltration Routes

3-50. When tactically feasible, tactical reconnaissance elements enter the urban area using infiltration techniques that allow orientation on the reconnaissance objective without having to engage the threat or fight through prepared defenses. Elements will infiltrate to establish urban observation posts and conduct surveillance or target acquisition on NAIs or targeted areas of interest. Because reconnaissance teams may be required to remain during BCT/RCT operations, these elements must carefully select positions for them and exfiltration routes if they are to leave the area during the conduct of the operation. A general rule of thumb is to exfiltrate on routes different from those used for infiltration. Parent or controlling units must also develop a plan to support the infiltrated teams.

Synchronize Aerial and Ground Reconnaissance Plans

3-51. In urban terrain, it is most effective to task-organize UAS assets to the lowest possible level. This will allow the company and troop commanders on the scene to control the employment of UAS assets and keep its use synchronized with reconnaissance operations. If the BCT/RCT chooses to maintain control of the UAS assets, it must ensure that the employment of the UAS supports the actions of the tactical reconnaissance elements and that these elements have direct access to the information being collected.

Develop Communication and Sustainment Plans

3-52. Communications in the urban environment require detailed planning that will allow units freedom of movement while maintaining control of elements dispersed within the urban environment. To communicate effectively and continuously, leaders must minimize limitations imposed by the urban environment and maximize the advantages of existing civil communications. Tactical reconnaissance elements must plan for redundant communications because of the limiting effects of urban terrain.

3-53. To ensure effective communications, the staff must identify terrain along the approach route and in the urban AO that supports line-of-sight communications. They coordinate to establish retransmission sites on supporting terrain or structures to facilitate the unit communication plan during the unit initial entry into the urban area.

3-54. In developing a sustainment plan to support the urban reconnaissance, the staff should identify potential logistics RPs that can be secured by limited forces. Stadiums, warehouse facilities in industrial transportation areas, and schools in dispersed residential areas are examples of possible logistics RPs. If the reconnaissance elements are tasked to conduct sustained operations or transition to stability operations, logistics RPs can be expanded into logistical sites or operating bases. Because of security considerations and the limited support vehicles and supplies available, casualty evacuation and vehicle recovery are the main logistical functions that should occur within the urban area.

Coordinate for Fire Support

3-55. From the ground unit perspective, helicopters are most effective when they operate under the operational control of the ground unit commander closest to the threat; therefore, company and troop commanders and platoon leaders must be proficient in directing attack helicopter fires. Because ground reconnaissance leaders can direct the efforts of only a few aircraft at a time, it may be more effective for the aviation unit to retain control of its individual aircraft. They then operate by continuously rotating attack helicopter elements into the battle area where they then coordinate their attacks with the ground commander's maneuver.

3-56. The staff must consider numerous factors when coordinating and planning targets that will support in an urban environment. The most likely mission that must be planned entails identifying targets to support

disengagement from unexpected or overwhelming contact. Examples of fire support considerations for urban terrain include the following:

- Do the rules of engagement support the use of lethal fires within the urban area?
- Who controls each fire support asset?
- Has the fire plan been exchanged with adjacent units?
- Has the observer plan been developed, including observation posts in buildings, location of laser designators, and overwatch of trigger points?
- Have locations of hazardous sites been identified? This includes above- and below-ground sites (fuel and industrial storage tanks, gas distribution lines) and other areas where incendiary effects of detonating artillery and mortar rounds could start structure fires.
- Has the general construction or composition of buildings and road surfaces been identified? This may affect the type of munitions used.
- Where do buildings, overhead power lines, or towers mask or degrade global positioning system devices and compasses?
- Will obscuration and illumination favor friendly or threat units?
- Will buildings or structures require fire support personnel to carry or use equipment not normally on hand (field expedient antennas, climbing ropes, wire gloves, axes, sledgehammers)?
- What are the requirements for radar coverage? Should radar zones be established? If so, where and how long?

3-57. The use of conventional and precision guided munitions must be carefully considered. The biggest consideration for using precision guided munitions is that some sort of laser or infrared designator equipment must be available. In the event these assets are not available, augmentation may be required from the BCT/RCT.

3-58. Reconnaissance elements may be supported by a variety of attack helicopters. The increased risk of small arms, rocket propelled grenade, and man-portable air defense system engagements means aviation forces normally support urban operations by operating away from built-up areas. If the risk analysis determines that the payoff is higher than the risk, aviation forces can be employed in and around the urban area. The most common missions assigned to attack helicopters in urban operations are the following:

- Reconnaissance.
- Security of friendly locations.
- Isolation of urban objectives.
- Precision engagement of hardened point targets.
- Interdiction and destruction of threat armored vehicles moving against friendly forces.

3-59. Aviation assets may also be called on to perform nontraditional roles in urban terrain. This is particularly true during stability in urban areas. Additional missions may include—

- Providing a limited relay of radio messages from isolated ground units.
- Videotaping or photographing routes or objectives for later analysis by ground commanders.
- Assisting, for limited periods, in the control and coordination of fires with the maneuver of ground forces.
- Marking or identifying specific buildings and areas by smoke, fires, or targeting lasers.
- Providing navigational and directional assistance to ground units.
- Providing countersniper and countermortar armed reconnaissance patrols around friendly unit locations.

3-60. Reconnaissance elements may be supported by a variety of assault or lift helicopters. These assets can be crucial for the flexible and responsive movement of troops and supplies. The most common missions assigned to assault or lift helicopters in the urban environment are—

- Air assault.
- Medical evacuation.
- Air movement of troops and supplies.

- Emplacement of logistics RPs.
- Control of ground forces (airborne command post).
- Noncombatant evacuation operations.
- Electronic warfare.
- Combat search and rescue. (Marines perform tactical recovery of aircraft and personnel vice combat search and rescue.)
- Emplacement of volcano mines.

3-61. The need to deliver hovering fires from a temporary battle position may require the aircraft to carry less than a full load of munitions or fuel. This is especially true in hot climates and high altitudes. Reduced loads mean more frequent trips to forward arming and refueling points and less time on station. Long route distances during air movements may require the establishment of forward arming and refueling points along the route before missions. Climate will also affect the number of troops or amount of supplies the aircraft can transport.

Improving the Urban Sketch

3-62. Because individual vehicles and sections execute urban reconnaissance, personnel must have an understanding of the sketch and reference system. Sketches are critical to visualize unit locations with detail and in obtaining precise location updates throughout the mission.

3-63. The staff confirms and updates urban sketches during planning and execution of urban operations and continues to add more detail throughout the operation. Specifically, reconnaissance elements assess entry routes that the BCT/RCT could use in support of operations. Because most maps do not provide the necessary level of detail to meet these important operational considerations, selected reconnaissance elements will usually have to create overlays to enhance situational understanding. Included with the sketches are overlays that categorize sections of the urban area by ethnicity, religious affiliation, and other prevailing characteristics that could affect operations. The consolidated sketches and overlays are used to create an urban map with overlays for the BCT/RCT.

URBAN TERRAIN (SUBTERRANEAN)

3-64. This section discusses reconnaissance to collect information on the use of tunnels, natural caves, or underground facilities by enemy forces. Caves and underground facilities can be used for command and control centers, logistics staging areas, hospitals, or fortifications. The larger underground facilities can be quite complex. They can be wired for electricity and communications and can have pumping stations for supplying air to lower levels. Caves can have many large chambers connected by passageways. Also, tunnel systems can have many large rooms joined by interconnecting tunnels. Search operations include a specified target, whereas the reconnaissance objective is to collect specified information. Search team organization and the reconnaissance team organization may differ significantly as well.

Note. This section should not be confused with the discussion on reconnaissance of tunnels on routes.

Tunnel Uses

3-65. Tunnels can be dug with zigzags and sumps to reduce the effects of small-arms fire, explosives, and gas. Some tunnels, rooms, passageways, or chambers can contain concealed exits to allow an enemy to hide or escape if the complex or cave is penetrated. Other tunnels can be booby-trapped to kill intruders. Tunnels and caves are hard to detect from the air or ground. Their construction can make them impossible to destroy with conventional ammunition. Tunnels can also be dug in the basement of safe houses for use as escape routes if a house is compromised. Tunnel entrances are normally covered by fire from another point in the complex.

3-66. An enemy can use tunnels in penetration operations to gain access to restricted areas. In built-up areas, the enemy can infiltrate through sewers or tunnel to its target from the basement of a nearby building, subway tunnel, or sewer. When an enemy is below the target, it can build an exit and penetrate the target from below or fill the tunnel with explosives and destroy the target.

3-67. Tunnels are used for approach and escape, for access to caves and underground bunkers, for firing positions, and for protection against indirect fires. They are also used as a common method for storing food and materials in underground caches. If large enough, some tunnel complexes can house underground hospitals and base camps.

Tunnel Detection

3-68. The first step in detecting or locating tunnels is to reduce a large geographical area of interest to a smaller area of interest or a smaller area of probable locations. This can be accomplished by studying indications of probable tunnel locations. Some indicators that tunnels are being employed by insurgent forces include—

- Movement of insurgents in a specific direction after being spotted by aircraft.
- Sniper fire occurring from areas where there are no obvious avenues of withdrawal.
- Vegetable gardens far from places of habitation.
- Operations where insurgents inflict casualties at relatively long range and disappear without making close contact or being detected by friendly forces.
- The smell of burning wood or food cooking in an area lacking habitation.

3-69. Conventional aerial photography produces results if the appearance of the surface and vegetation is changed from the normal. This requires skilled personnel to interpret photographs. In a jungle environment, aerial photography may be prohibited since dense vegetation (such as double or triple canopy jungle) obscures the ground.

3-70. Once it is determined that a certain area may contain a tunnel system, several indicators can be helpful in detecting tunnels. Visual inspections often disclose the general area of a tunnel but not the precise location. The key to finding a tunnel system is applying common sense to the situation. A platoon, company, or troop should be assigned a small search area (never larger than a 1,000-meter grid square). These small areas are chosen based on intelligence reports or on past actions of the enemy force. The unit searches every square meter of the area. Some visual indicators usually found include—

- Worn places on trees that were used as handholds.
- A small trail (much like a game trail) through brush into a clump of small trees.
- Cut trees (not a sure indicator).
- Limbs tied near the treetop to conceal the use of a tunnel from aircraft.
- A slight depression in or around a group of small trees.
- Air holes (sure indicators).
- A lone individual, mainly a female, in the area.
- Freshly cooked food with no one attending the site.
- Fresh human feces in the area.

3-71. These are all good indicators; however, they can vary depending on the area. The places to look for indicators are in the corners of hedgerows, trails, and streams. The enemy often hides in these places to see without being seen. Also, hiding in these places allows those who finished the camouflage to escape undetected. The insurgents are aware of the danger of setting a pattern; however, they must have a location that provides observation and concealment. Soldiers and Marines should look for observation posts that allow the insurgent to move into or out of an area undetected.

3-72. Sometimes, the exact location of a tunnel can be obtained by questioning the local populace or prisoners who may have occupied or helped dig the system. Due to compartmentalization, they may not be able to locate an entrance or exit unless they have seen or used the completed tunnel.

Tunnel Reconnaissance

3-73. Entering an area where a tunnel complex is located requires a methodical approach. Security to the flanks and rear is imperative. The size of the objective AO determines the strength of the unit assigned the search mission. The unit, company, or platoon is task-organized for tunnel operations. Elements include the following:

- Security element (plus headquarters element to cordon search area).
- Search element (to search the immediate area for tunnels). The search element is subdivided into search and security teams.
- Reserve element (to assist in cordon and reinforce as needed).

3-74. The techniques of a deliberate search are centered on the rifle squad. Each squad is divided into a security and a search team. A slow methodical search is conducted in the AO. Once assigned a search area, the squad systematically searches every square meter. The security element moves toward the limits of the search area. Once a tunnel is discovered, the security element surrounds the area while the search team prepares to destroy or neutralize the tunnel.

3-75. The reconnaissance element may require the following special items to perform tunnel operations:

- **Mine detectors.** Mine detectors are used to detect ammunition and weapon caches.
- **Grenades.** Grenades are fragmentary, smoke, white phosphorus, and concussion types. Grenades should not be used after friendly forces have entered a tunnel.
- **Demolitions.** Demolitions are used to destroy tunnel systems. Due to the complexity of charges needed to destroy some tunnel complexes, an engineer team should support the search unit. Also, the large amount of demolitions required for some operations can present unique logistics problems, mainly in a jungle environment. (See ATTP 3-06.11 for additional information on the urban environment.)
- **Air generator.** An air generator is used to force smoke into a tunnel complex.
- **Flashlights.** Flashlights are used to search tunnels.
- **Weapons.** Pistols should be used inside tunnels. The pistol has good stopping power and is effective at close range.
- **Loudspeaker.** A loudspeaker is used to call the enemy from tunnels.

3-76. Tactical reconnaissance will require engineer support in all types of terrain and climate. The advantages and disadvantages of each environment are considered in the planning and conduct of ERT operations. The ERTs conduct route, zone, and area reconnaissance in jungles, mountainous areas, deserts, and cold regions; the ERTs employ specialized knowledge, skills, techniques, and equipment for each of these areas. This section presents characteristics of four environments that affect tactical engineer reconnaissance support and the associated considerations.

JUNGLE TERRAIN

3-77. Jungles are humid, tropic areas with a dense growth of trees and vegetation. Typically, visibility is less than 100 feet, and areas are sparsely populated. Mounted infantry and armor units are limited in jungle areas. Jungle vegetation provides excellent concealment from air and ground observation. Vegetation does not provide adequate cover from small caliber direct-fire and artillery indirect-fire fragments. Adequate cover is available using the natural ravines and gullies produced by erosion from the high annual rainfall in the area. Few natural or locally procurable materials are available in jungle areas. Other considerations are high water tables, dense undergrowth, and tree roots (often requiring aboveground level protective construction).

3-78. The focus of engineer reconnaissance support in jungle terrain is influenced by the engineer tasks typically conducted. The following discussion highlights common mobility/countermobility/survivability tasks requiring engineer reconnaissance in jungle terrain.

3-79. The construction and maintenance of roads, tracks, and trails are the initial means of improving mobility. Heavy rainfall, the clearance of vegetation, drainage, and the movement of equipment and materials all combine to make this a long and painstaking task. Once constructed, routes will need regular maintenance. Landing sites and drop zones will also need to be constructed to enhance the ability to move troops and stores

by air transport and helicopters. However, with training and advice, other nonengineer troops should also be able to take on some of these tasks. Crossing obstacles (such as large rivers) may require engineer advice, support and, possibly, equipment; but once suitable material for the construction of boats, rafts, and small bridges has been provided, other troops will often be able to complete the task. Bridging of obstacles to allow vehicle passage normally requires special equipment, and it should remain an engineer task. Minefields in the jungle are likely to be of the nuisance or protective variety, and they will remain an engineer task for clearance. Engineers may also be required to reduce enemy defensive positions and clear explosive hazards.

3-80. The main countermobility tasks for engineers will be to block roads, tracks, and trails; employ mines and booby traps (where rules of engagement permit); and carry out demolitions. Blocking roads, tracks, and trails is always particularly effective to provide opportunities for counteraction (ambush, air strike). Countermobility tasks may also assist in developing a deception plan if it is coordinated at the highest appropriate level.

3-81. Engineers may be required to construct defensive positions, field fortification (including artillery gun positions), and protective locations for combat supplies. Engineers will have a large variety of other tasks and commitments that will demand their advice and attention. In the early stages of a deployment, engineers are most likely to be concerned with establishing a secure base.

MOUNTAINOUS TERRAIN

3-82. Characteristics of mountain ranges include rugged and poorly trafficable terrain, steep slopes, and altitudes greater than 1,600 feet. Irregular mountain terrain provides numerous places for cover and concealment. Because of rocky ground, it is difficult and often impossible to dig below ground positions; therefore, boulders and loose rocks are used in aboveground construction. Construction materials used for structural and shielding components are most often indigenous rocks, boulders, and rocky soil. Often, rock formations are used as structural wall components without modification. Conventional tools are inadequate for preparing individual and crew-served weapons fighting positions in rocky terrain. Engineers assist with light equipment and tools (such as pneumatic jackhammers). These tools are delivered to mountain areas by helicopter. Explosives and demolitions are used extensively for positions requiring rock and boulder removal.

3-83. The focus of engineer reconnaissance support in mountainous terrain is influenced by the engineer tasks typically conducted. (See FM 3-97.6 for additional information on mountainous terrain.)

3-84. Mobility support is likely to be the major task, particularly the construction, improvement, and maintenance of routes. Main supply routes may be vulnerable, particularly where they run through defiles. The provision of drainage and bridging is likely to be required because of the large number of mountain streams and their susceptibility to flash flooding. New bridges may be required to cross streams, replace weak bridges, and cross gorges. Constructing new routes is likely to involve major engineering work, especially excavation and fill. Because of the shortage of routes and restricted access, the following mobility tasks will also assume particular significance:

- Clearing obstacles.
- Constructing passing and parking areas.
- Clearing snow.
- Constructing helicopter landing sites.
- Supporting tasks related to resupply by air.

3-85. As routes are restricted, the effect of obstacles will be greatly enhanced. Blocking roads and passes, destroying tunnels, and laying mines are particularly effective in rugged terrain. Care must be taken not to restrict the movement of friendly forces. All obstacles may have to be coordinated at a higher formation level than for normal operations.

3-86. Digging in may be difficult even when using explosive means. It is likely that defensive positions will largely be based on raised fortifications. The construction of defensive positions remains an all arms/branches responsibility, but engineers may be called upon to provide advice and enhanced engineer capabilities to support their efforts. Some measure of tunneling may even be required. Irregular mountain terrain provides many opportunities for cover and concealment. Light engineer equipment transported by helicopters can

provide valuable assistance in protecting maneuver units. There may also be the need to construct support bases for indirect-fire weapons.

3-87. Other common engineer tasks may include—

- Constructing and operating aerial ropeways.
- Constructing logistic facilities.
- Supporting antihelicopter measures.
- Supporting remote signals sites.
- Supporting surveying.

DESERT TERRAIN

3-88. Deserts are extensive, arid, and treeless. Deserts have a severe lack of rainfall and extreme daily temperature fluctuations. The terrain is sandy with boulder-strewn areas, mountains, dunes, deeply eroded valleys, areas of rock and shale, and salt marshes. Effective natural barriers are found in steep slope rock formations. Wadis and other dried up drainage features are used extensively for protective position placement. Camouflage, concealment, and light and noise discipline are important considerations in desert terrain. Target acquisition and observation are relatively easy in desert terrain. (See FM 90-3 for additional information on desert considerations.)

3-89. The focus of engineer reconnaissance support in desert terrain is influenced by the engineer tasks typically conducted. The following discussion highlights common M/CM/S tasks in desert terrain.

3-90. The vastness of the desert makes mobility a prime concern. Cross-country mobility may be poor in soft sand, rocky areas, and salt flats. Greater engineer reconnaissance effort will be needed to identify routes, existing obstacles, and minefield locations. Engineer tasks may include—

- Assisting maneuvers by reducing slopes, smoothing rock steps, and maintaining routes.
- Providing dry-gap crossings, including those required to traverse oil pipelines.
- Increasing weight-bearing capacity through soil stabilization to provide good roads or sites for aircraft landing strips or helicopter landing zones.
- Employing dust abatement materials to support aircraft operations at landing strips and landing zones.
- Obscuring enemy lines of sight during breaching.

3-91. To be of tactical value in the desert, a minefield must usually cover a relatively large area. Mechanical and scatterable mines may be widely used in desert terrain. Scatterable mines may also be widely used. Since there are often too many avenues of approach to be covered with mines, it is usually best to employ tactical minefields to cover gaps between units, especially for night defense. Target-oriented obstacles may often be the best choice to reduce enemy mobility. Terrain dependent obstacles may be extensive and must be used in conjunction with each other and with any natural obstacles. All obstacles should support engagement areas.

3-92. Sand is effective in covering mines. However, shifting sand creates potential problems, such as exposing the mines (causing malfunctions) or accumulating excessive sand (degrading performance). Shifting sand can also cause mines to drift. Antitank ditches require extensive preparation time and may require extensive maintenance. Caution must be exercised to prevent the ditch from identifying a defensive front or flank and to deny their use as protection for enemy infantry.

3-93. Deserts provide little cover and concealment from ground-based observers and even less from aircraft. Because of the lack of concealment, camouflage must often be used. Hull and turret defilade positions for tactical vehicles may be important. Dispersion and frequent moves are other survivability techniques. Preparation of fortifications in the desert is difficult. Sandy soil requires revetments, while rocky plains or plateaus may be impossible to dig in. To counter this problem, emplacements are built up with rocks, and depressions are used when possible. Hardening of facilities and nodes and upgrades to, or construction of, forward landing strips and main supply routes are important in the desert.

COLD REGION TERRAIN

3-94. Cold regions of the world are characterized by deep snow, permafrost, seasonally frozen ground, frozen lakes and rivers, glaciers, and long periods of extremely cold temperatures. Digging in frozen or semifrozen ground is difficult with equipment and virtually impossible for personnel using an entrenching tool. Fighting and protective position construction in snow or frozen ground takes twice as long as positions in unfrozen ground. Operations in cold regions are affected by wind and the possibility of thaw during warming periods. An unexpected thaw causes a severe drop in the soil strength, which creates mud and drainage problems. Positions near bodies of water (lakes, rivers) are carefully located to prevent flooding damage during the spring melting season. Wind protection greatly decreases the effects of cold on personnel and equipment. (See ATTP 3-97.11/MCRP 3-35.1D for additional information on arctic and cold regions.)

SUPPORT TO OTHER RECONNAISSANCE TYPES

3-95. Generally, other types of engineer reconnaissance are intended to support a survey by technical elements. The search, environmental assessment, and infrastructure assessment are usually linked to urban locations, although not exclusively.

SEARCH

3-96. The ERTs support military search by collecting technical information on the potential target of the search. The information collected through route, zone, or area reconnaissance supports the planning and targeting for subsequent search operations. While the ERT and search team are distinct and mission specific organizations, the ERT can be augmented by a military search advisor to ensure that the information collected is relevant to planned search operations. Each team has the potential to enable the other team.

ENVIRONMENTAL ASSESSMENT

3-97. If the tactical situation permits, commanders conduct or direct an environmental baseline survey before occupying the AO in conjunction with an environmental health site assessment. An environmental baseline survey is typically performed by or with support from and centered on general engineer elements supported by other technical specialties. An environmental health site assessment is performed by a team centered on preventive medicine personnel and supported by other technical specialties. The ERTs may need to perform an initial site assessment to gather information for an environmental baseline survey and the engineer portion of the environmental health site assessment.

INFRASTRUCTURE ASSESSMENT

3-98. The reconnaissance of infrastructure is accomplished in two stages (the infrastructure assessment and the infrastructure survey). Since it is most likely that combat engineer units will be onsite first, an ERT can be expected to conduct the initial assessment with the other technical expertise that is available in the unit the ERT is supporting. The ERT uses a series of smartcards to determine the infrastructure capacity. The initial infrastructure assessment will then be provided to a specialist in the field for the assessment area evaluated. As operations mature, supporting technical elements will be available to provide teams who are qualified to perform a comprehensive infrastructure survey. The infrastructure survey teams use the infrastructure assessments that were prepared by the ERTs to prioritize the categories and parts of the infrastructure that require reexamination during the infrastructure survey. The U.S. Army Corps of Engineers and Naval Facilities Engineering Command will normally perform thorough assessments with field force engineering assigned specialty designated teams.

Chapter 4

Technical Reconnaissance—Route Classification

The ERTs, engineer assessment teams, and survey teams collect technical information to determine a route classification for specified routes. The classification is displayed using a route classification format and route symbols on an overlay. Assessment and survey teams employ a high degree of technical expertise, and the assessment and survey teams are focused on detailed technical information required for design of repairs or upgrades along the route. The capabilities in both cases overlap substantially, and these capabilities could be conducted in phases. This chapter discusses the technical information required for a route classification.

ROUTE CLASSIFICATION

4-1. Route classification information is collected, assembled, and retained as supporting data for a graphical representation. This data is also useful in planning and designing repairs and upgrades along the route. While ERTs provide a degree of technical expertise in many route classification components, they operate as an integrated part of an overall reconnaissance effort at the BCT/RCT level and below. The ERT would typically conduct a route reconnaissance with a specified additional focus on collecting information required to assign a classification. Technical augmentation to ERTs adds to the degree of technical expertise available to collect information that is more detailed on specific route components, to include roadbeds, bridges, tunnels, and other limiting factors of the route. An ERT will conduct an initial route reconnaissance to collect only the technical information required to determine the overall classification of the route.

4-2. Route classification results from collecting detailed technical information on various components and sections of a designated route. Route classification provides a graphical display of the load-carrying capacity and number of vehicles that can travel the route over a period of time on a selected route. The designated route components are reconnoitered, and a classification is determined. The resulting classification and the graphical information from the classification components are displayed as a route classification overlay, which may be included directly on the common operational picture. It is supplemented by the components report documentation that is generated to determine the classification. A route classification may only include the details about restrictions or limitations of the route or section of a route.

4-3. Hasty route reconnaissance includes only the essential facts about a route. Information is gathered as quickly and safely as possible during a route reconnaissance. The ERTs are most likely employed to collect technical information. The results of the reconnaissance may not provide the detailed information necessary to determine a full route classification. The tempo of the reconnaissance element will dictate the tempo of the ERT ability to gather sufficient technical information to classify the route. As the primary use of the route shifts to sustainment, the reconnaissance focus may change to collecting the information necessary to assess improvements along the route, but more likely, a supporting general engineer element will be tasked to conduct the necessary assessment. During stability, detailed route classification and a broader selection of the route components are performed to obtain in-depth information for upgrade or maintenance of, or along, the route.

4-4. Routes are classified by obtaining pertinent information concerning trafficability and applying it to the route classification format. The lowest rating from any section (road segment or restriction) of the route constitutes the overall route classification. DD Form 3010; DD Form 3011, *Bridge Reconnaissance Report*; DD Form 3012, *Tunnel Reconnaissance Report*; DD Form 3013, *Ford Reconnaissance Report*; and DD Form 3014, *Ferry Reconnaissance Report*, help organize the reconnaissance information that is collected. These forms are covered in detail in appendix B.

ROUTE CLASSIFICATION OVERLAY

4-5. A route classification overlay graphically depicts the network of roads, bridge sites, and other components of a route. The route components are reconnoitered and the data recorded as support documentation for the complete route. A route classification overlay gives specific details on what obstructions will slow down a convoy or maneuver force along a route. The following information is included on the route classification overlay (see figure 4-1):

- The route classification format.
- The name and rank of the person in charge.
- The unit conducting the classification.
- The date-time group that the classification was conducted.
- The map name, edition, and scale. Ensure that a North arrow and grid reference marks are indicated on the overlay.
- The remarks necessary to ensure complete understanding of the information on the overlay. Include—
 - A route name, when applicable.
 - A legend for any nonstandard symbols used on the overlay.
- The overlay classification (classified or unclassified).
- The limits of the route reconnoitered (indicated by an open arrowhead on the side of the route). Route segments are labeled with an alphanumeric designation.

BYPASSES

4-6. A bypass is a detour along a route that allows traffic to avoid an obstruction. Bypasses limited to specific vehicle types (such as those capable of swimming or deep-water fording) are noted on the reconnaissance report. Bypasses are classified as easy, difficult, or impossible. Use *bypass easy* when the obstacle can be crossed in the immediate vicinity by a family of medium tactical vehicles without work to improve the bypass. Use *bypass difficult* when the obstacle can be crossed in the immediate vicinity, but some work to improve the bypass is necessary (the estimation of time, troops, and equipment necessary to prepare the bypass is included on the reconnaissance report). Use *bypass impossible* when the obstacle can be crossed only by repairing the existing bridge, constructing a new bridge or tunnel, or by constructing a detour. Each type of bypass is represented symbolically on the arrow extending from the symbol to the map location. (See appendix B for bypass symbols.)

FORMAT

4-7. The route classification format is derived from information gathered during the route reconnaissance and reconnaissance of key components of the route. The format is recorded on the route classification overlay (see the route classification format in table 4-1, page 4-4). The format consists of the following:

- (1) Traveled-way width (in meters).
- (2) Route type.
 - All weather (X).
 - Limited, all weather (Y).
 - Fair weather (Z).
- (3) Lowest MLC.
- (4) Lowest overhead clearance (in meters).
- (5) Obstructions to traffic flow (OB).
- (6) Seasonal conditions, such as snow blockage (T) or flooding (W), as required.

Note. Use this example format for the route classification format.

(1) / (2) / (3) / (4) / (5) / (6)

5.5 / Y / 30 / 4.6 / (OB) / (T or W)

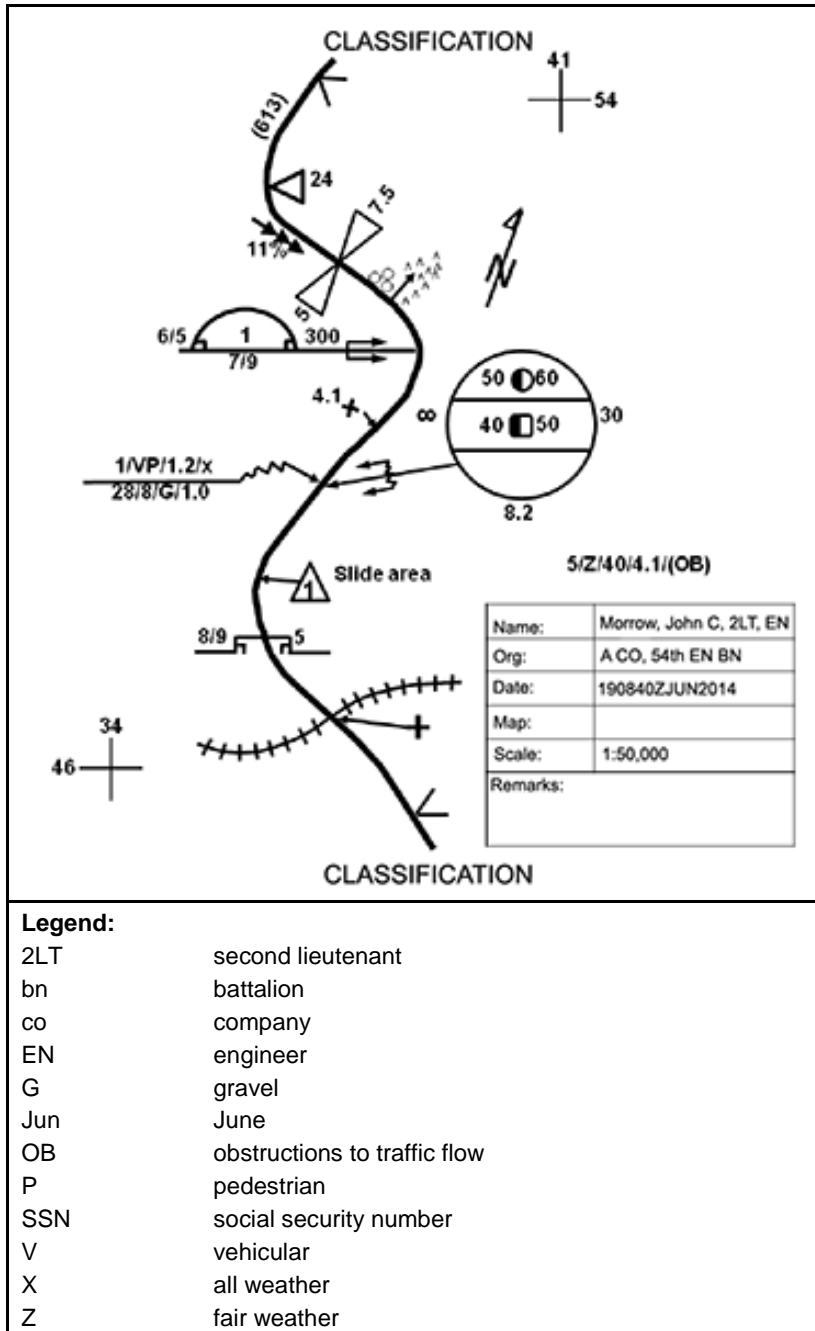

Figure 4-1. Route classification overlay

Table 4-1. Examples of the route classification format

<i>Route Classification Format</i>	<i>Description</i>
6.1/Z/40/∞	A fair-weather route with a minimum traveled way of 6.1 meters and an MLC of 40. Overhead clearance is unlimited, and there are no obstructions to traffic flow. This route, based on its minimum traveled-way width, accommodates wheeled and tracked, single-flow traffic without obstructions.
6.1/Z/40/∞/OB	A fair-weather route similar to the previous example except there is an obstruction. This obstruction could consist of overhead clearances of less than 4.3 meters, grades of 7% or greater, curves with a radius of 25 meters or less, fords, and ferries. A traveled way of 6.1 meters limits this route to one-way traffic without a width obstruction. If the route is used for double-flow traffic, then 6.1 meters of traveled way is considered an obstruction, and it is indicated in the format as an obstruction.
7/Y/50/4.6/OB	A limited, all-weather route with a minimum traveled way of 7 meters, an MLC of 50, an overhead clearance of 4.6 meters, and an obstruction. This route width is not suitable for double-flow traffic (wheeled or tracked). This width constriction is indicated as OB in the route classification format if the route is used for double-flow traffic.
10.5/X/120/∞/OB/W	An all-weather route with a minimum traveled-way width of 10.5 meters (suitable for two-way traffic of wheeled and tracked vehicles; an MLC of 120; unlimited overhead clearance; an obstruction; and regular, recurrent flooding).
Legend:	
MLC	military load classification
OB	obstruction
W	flooding
X	all weather
Y	limited, all weather
Z	fair weather

(1) Traveled-Way Width

4-8. The traveled-way width is the narrowest width of traveled way on a route. (See figure 4-2 for additional information.) This narrow width may be the width of a bridge, tunnel, road, underpass, or other constriction that limits the traveled-way width. The number of lanes is determined by the traveled-way width. The lane width normally required for wheeled vehicles is 3.5 meters and 4.0 meters for tracked vehicles.

4-9. According to the number of lanes, a road or route can be classified—

- **Limited access.** Permits the passage of isolated vehicles of an appropriate width in one direction only.
- **Single lane.** Permits passage in only one direction at any one time. Passing or movement in the opposite direction is impossible.
- **Single flow.** Permits the passage of a column of vehicles and allows isolated vehicles to pass or travel in the opposite direction at predetermined points.
- **Double flow.** Permits two columns of vehicles to proceed simultaneously. Such a route must be at least two lanes wide.

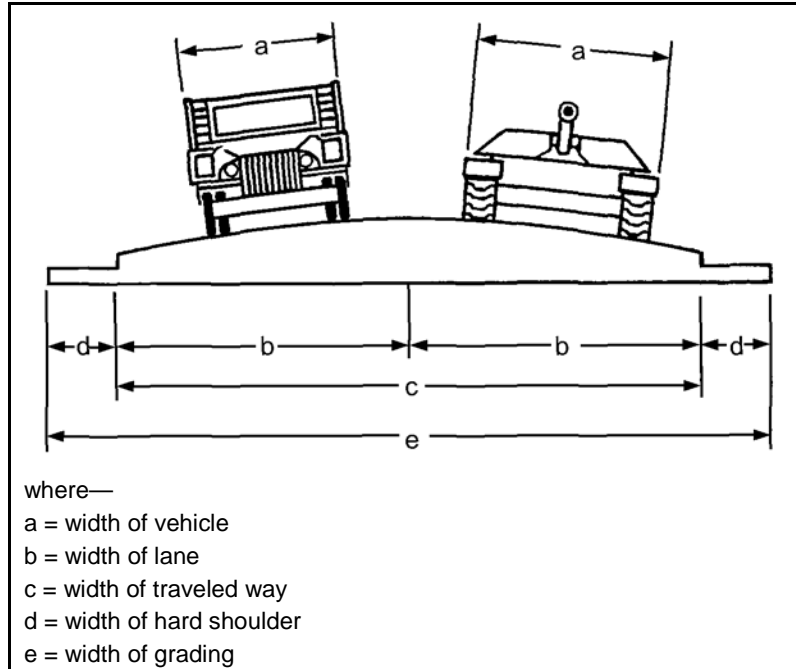

Figure 4-2. Route widths

(2) Route Type

4-10. The route type is determined by the ability to withstand weather. It is determined by the worst section of road on the entire route and is categorized as follows:

- **Type X.** An all-weather route that, with reasonable maintenance, is passable throughout the year to a volume of traffic never appreciably less than its maximum capacity. This type of route is normally formed of roads having waterproof surfaces and being only slightly affected by rain, frost, thaw, or heat. This type of route is never closed because of weather effects other than snow or flood blockage.
- **Type Y.** A limited, all-weather route that is passable throughout the year with reasonable maintenance, but at times has a volume of traffic considerably less than maximum capacity. This type of route usually consists of roads that do not have waterproof surfaces. The route is considerably affected by rain, frost, thaw, or heat. This type of route is closed for short periods (up to one day at a time) by adverse weather conditions during which heavy use of the road would probably lead to complete collapse.
- **Type Z.** A fair-weather route is passable only in fair weather. This type of route is so seriously affected by adverse weather conditions that it may remain closed for long periods. Improvement of such a route can only be achieved by construction or realignment.

(3) Lowest Military Load Classification

4-11. A route MLC is a weight load classification number that represents the safe load carrying capacity, and it indicates the maximum vehicle class that can be accepted under normal conditions. Usually, the lowest bridge MLC (regardless of the vehicle type or conditions of traffic flow) determines the route MLC. If there is not a bridge on the route, the worst section of road will determine the overall classification of the route.

4-12. In cases where vehicles have a higher MLC than the route, an alternate route may be sought or an additional reconnaissance of sections within the route may be necessary to determine whether a change in traffic flow (such as single-flow crossing of a weak point) will permit heavier vehicles on the route. When possible, ensure that the number of classes of traffic routes (by type) is included. This helps staff planners manage traffic control along the routes. The entire network class is determined by the minimum load classification of a road or a bridge within the network.

- 4-13. The broad categories are—
- Class 50, average-traffic route.
 - Class 80, heavy-traffic route.
 - Class 120, very heavy-traffic route.

(4) Lowest Overhead Clearance

4-14. The lowest overhead clearance is the vertical distance between the road surface and any overhead obstacle that denies the use of the road to some vehicles. Use the infinity symbol for unlimited clearance in the route classification format. Points along the route where the minimum overhead clearance is less than 4.3 meters are considered an obstruction.

(5) Obstructions to Traffic Flow

4-15. Route obstructions restrict the type, amount, or speed of traffic flow. They are indicated in the route classification format by the annotation OB. If an obstruction is encountered, its exact nature must be depicted on the route classification overlay. Obstructions include—

- Overhead obstructions, to include tunnels, underpasses, overhead wires, and overhanging buildings with a clearance of less than 4.3 meters.
- Reductions in traveled-way widths that are below the standard minimums prescribed for the type of traffic flow. (See table 4-2.) This includes reductions caused by bridges, tunnels, craters, lanes through mined areas, projecting buildings, or rubble.
- Slopes (gradients) of 7 percent or greater.
- Curves with a radius of 25 meters and less. Curves with a radius of 25.1 to 45 meters are not considered an obstruction; however, they must be recorded on the route classification overlay.
- Ferries.
- Fords.

Table 4-2. Traffic flow capability based on route width

	<i>Limited Access</i>	<i>Single Lane</i>	<i>Single Flow</i>	<i>Double Flow</i>
Wheeled	At least 3.5 meters	3.5 to 5.5 meters	5.5 to 7.3 meters	Over 7.3 meters
Tracked or a combination of vehicles	At least 4.0 meters	4.0 to 6.0 meters	6.0 to 8.0 meters	Over 8 meters

Seasonal Conditions

4-16. In cases where snow blockage is serious and blocks traffic on a regular and recurrent basis, the symbol following the route classification format is T. In cases where flooding is serious and blocks traffic on a regular and recurrent basis, the symbol following the route classification format is W.

CURVE CALCULATIONS

4-17. The speed at which vehicles move along a route is affected by sharp curves. Curves with a radius of 25 meters or less are obstructions to traffic. These curves are indicated as obstructions on the route classification format by the annotation OB, and they are identified on DD Form 3010. (See appendix B.) Curves with a radius between 25.1 and 45 meters are recorded on the overlay, but they are not considered obstructions.

MEASURING METHODS

4-18. There are three primary methods used to measure curves. Each of the following methods provide adequate information about the curve:

- Tape measure.
- Triangulation.
- Chord.

Tape-Measure Method

4-19. A quick way to estimate the radius of a sharp curve is by using a tape measure to find the radius. (See figure 4-3.) Imagine the outer edge of the curve as the outer edge of a circle. Find (estimate) the center of this imaginary circle and then measure the radius using a tape measure. Start from the center of the circle and measure to the outside edge of the curve. The length of the tape measure from the center of the imaginary circle to its outer edge is the curve radius. This method is practical for curves located on relatively flat ground and having a radius up to 15 meters.

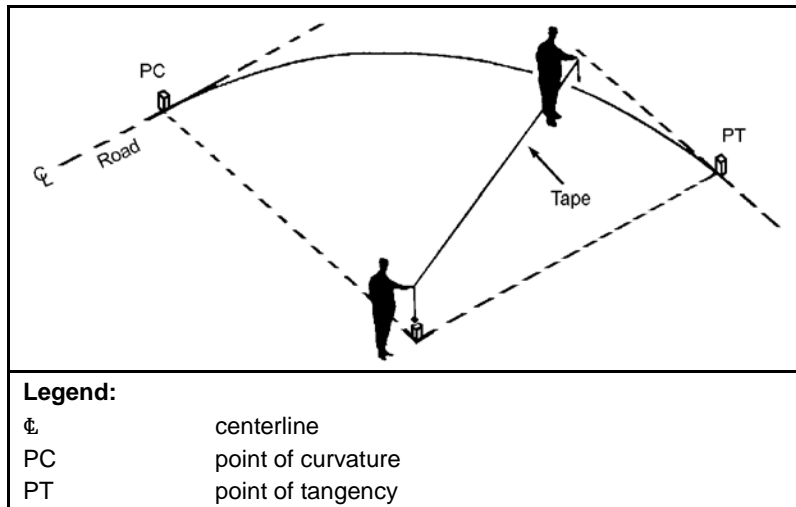

Figure 4-3. Tape-measure method

Triangulation Method

4-20. The approximate radius of a curve can be determined by laying out right triangles (Pythagorean theorem) at the point of curvature and point of tangency locations. (See figure 4-4, page 4-8.) A right angle is created by using a leg 3 feet, a leg 4 feet, and a leg 5 feet (or a proportional ratio of 3/4/5). The intersection (o), which is formed by extending the legs of each triangle, represents the center of the circle. The distance (R) from point (o) to point PC or PT represents the curve radius.

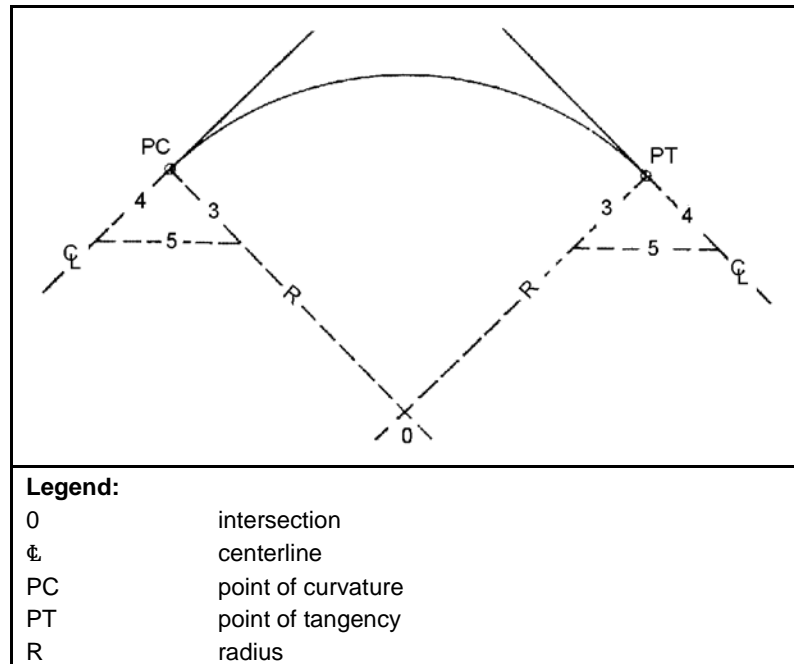

Figure 4-4. Triangulation method

Chord Method

4-21. The chord method can also be used to determine the curve radius. (See figure 4-5.) The chord method is based on the formula below:

$$R = \frac{M^2 + C^2}{2M}$$

where—

R = radius of the curve

C = 1/2 the distance from the centerline of the road at the outer extremities of the curve

M = perpendicular distance from the center of the tape to the centerline of the road

Note. When conditions warrant, set the perpendicular distance at 4 meters from the centerline and then measure the distance from the centerline at 2 meters. Use this method when there is a time limitation or because natural or man-made restrictions prevent proper measurements.

4-22. For example, if the distance from the centerline of the road to the centerline of the road at the outer extremities of the curve is 24 meters and the perpendicular distance from the center of the tape, 12 meters to the centerline of the road is fixed at 4 meters—

$$R = \frac{12^2 + 4^2}{2 \times 2}$$

$$R = \left(\frac{160}{8}\right) = 20$$

where—

R = radius of the curve

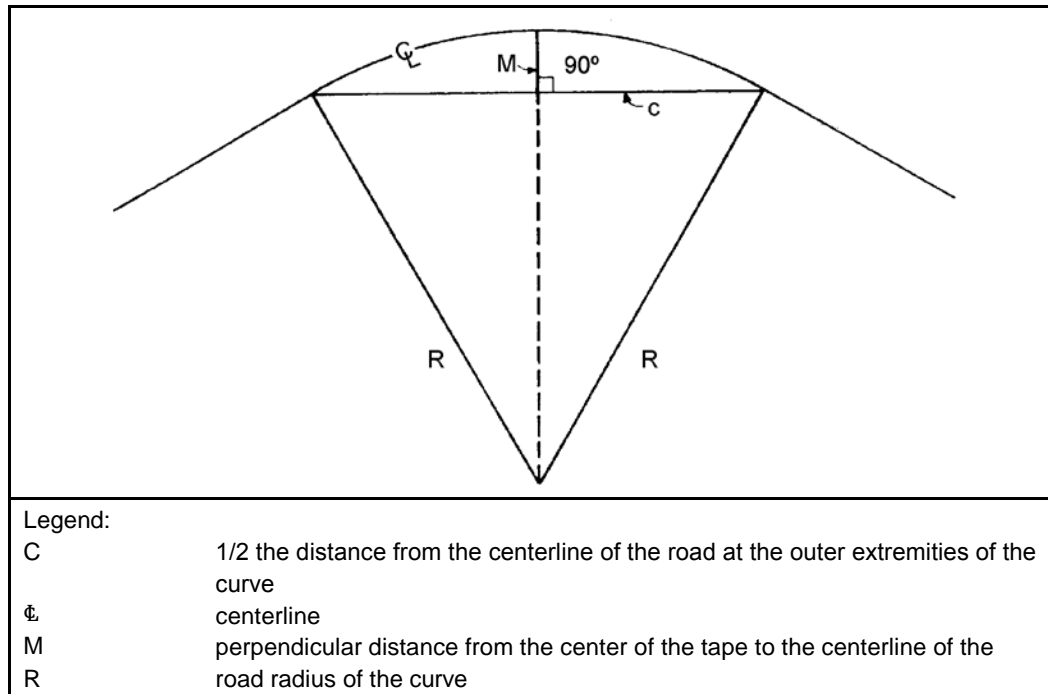

Figure 4-5. Chord method

4-23. The result of this calculation would be an obstruction to traffic flow. The obstruction (OB) is annotated in the route classification format.

CURVE SYMBOL

4-24. Sharp curves with a radius of 45 meters or less are symbolically represented on maps or overlays by a triangle that points to the exact map location of the curve. The measured value (in meters) for the radius of curvature is written outside the triangle. (See figure 4-6.) All curves with a radius of 45 meters are reportable, and are noted on DD Form 3010.

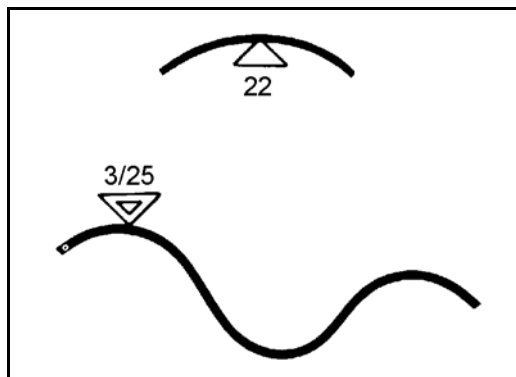

Figure 4-6. Curve symbols

4-25. A series of sharp curves is represented by two triangles, one drawn inside the other. The series of sharp curves symbol is annotated when there is insufficient space on the graphic to annotate multiple representations. The outer triangle points to the location of the first curve. The number of curves and the radius of curvature for the sharpest curve of the series is written to the outside of the triangle. (See figure 4-6).

SLOPE ESTIMATION

4-26. The rise and fall of the ground is known as the slope or gradient (grade). A slope of 7 percent or greater affects movement speeds along a route, and it is considered an obstruction. The percent of slope is used to describe the effect that inclines have on movement rates. The percent of slope is the ratio of the change in elevation (the vertical distance to the horizontal ground distance) multiplied by 100. (See figure 4-7.) It is important to express the vertical distance and the horizontal distance in the same unit of measure. Report slopes greater than 5 percent on the route classification overlay.

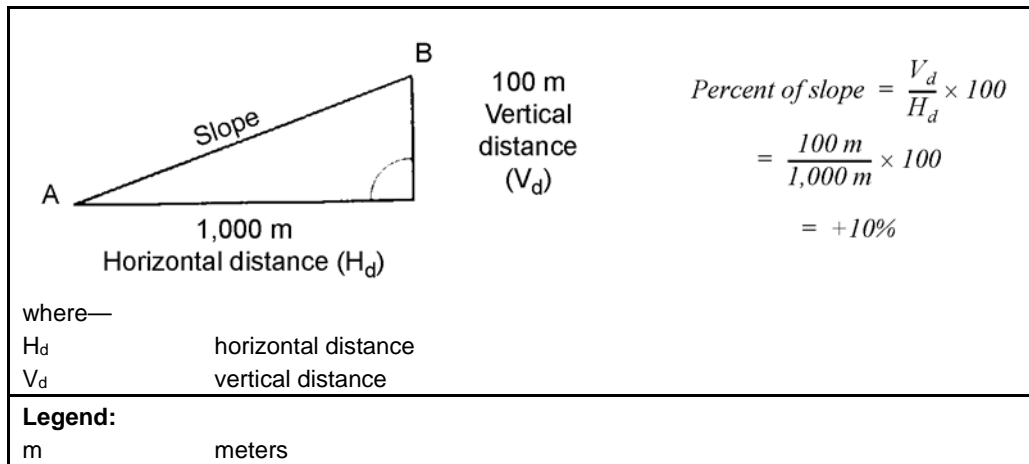

Figure 4-7. Percent of slope format

Percent of Slope

4-27. There are four general methods to determine the percent of slope:

- Clinometer.
- Map.
- Pace.
- Angle of slope.

Clinometer Method

4-28. A clinometer is an instrument that directly measures the percent of slope. Clinometers are found in engineer survey units, as part of an artillery compass, and integrated on some vehicles. The aim point for vehicle-mounted clinometers must take into account the height of the clinometer off the ground to the point of aim above the ground at the top of the slope.

Map Method

4-29. Use a large-scale map (such as 1:50,000) to estimate the percent of slope quickly. After identifying the slope on the map, find the difference in elevations between the top and bottom of the slope by reading the elevation contours or spot elevation. Then, measure and convert the horizontal distance (usually road distance) to the same unit of measurement as the elevation difference. Substitute the vertical and horizontal distances in the percent-of-slope format and compute the percent of slope. (See figure 4-8.)

Pace Method

4-30. The pace method is a quick way to estimate percent of slope. First, determine the height and pace for each member of the reconnaissance team. As a rule of thumb, the eye level of the average person is 1.75 meters above the ground. The pace of the average person is 0.75 meter.

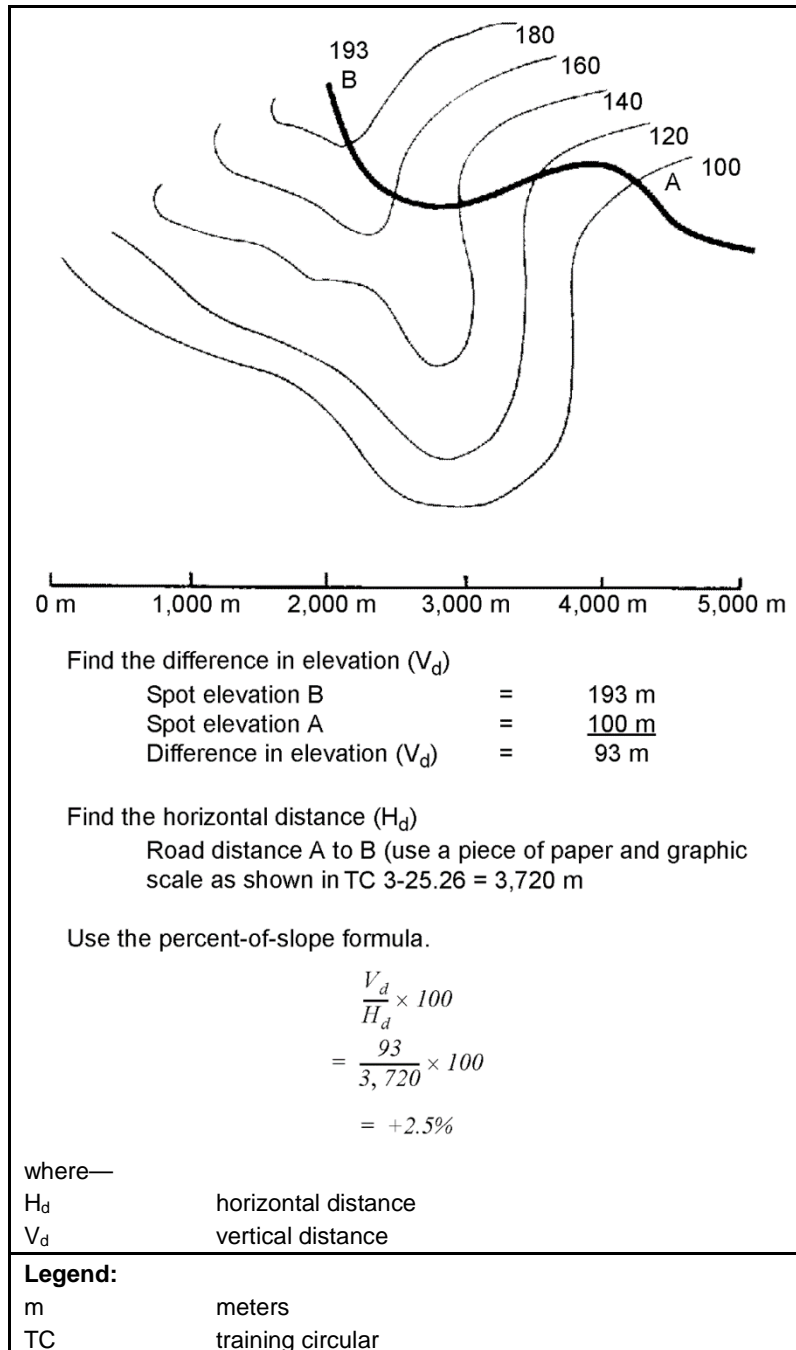

Figure 4-8. Map method to determine percent of slope

4-31. Perform the following procedures for the pace method:

- Stand at the bottom of the slope with your head and eyes level.
- Sight a spot on the slope. This spot should be easily identifiable. If it is not, another member of the team should go forward to mark the location.
- Walk forward and stand on the marked spot. Record the number of paces. Repeat this procedure until the top of the slope (estimate fractions of an eye level) is reached.

- Compute the vertical distance by multiplying the number of sightings by the eye-level height (1.75 meters). Compute the horizontal distance by totaling the number of paces and converting them to meters by multiplying by 0.75 (or the known pace-to-meter conversion factor).
- Calculate the percent of slope by substituting the values into the percent-of-slope format. (See figure 4-9.) Because this method considers horizontal ground distance and incline distance as equal, reasonable accuracy can only be obtained for slopes less than 30 percent. This method requires practice to achieve acceptable accuracy. A line level and string can be used to train this method.

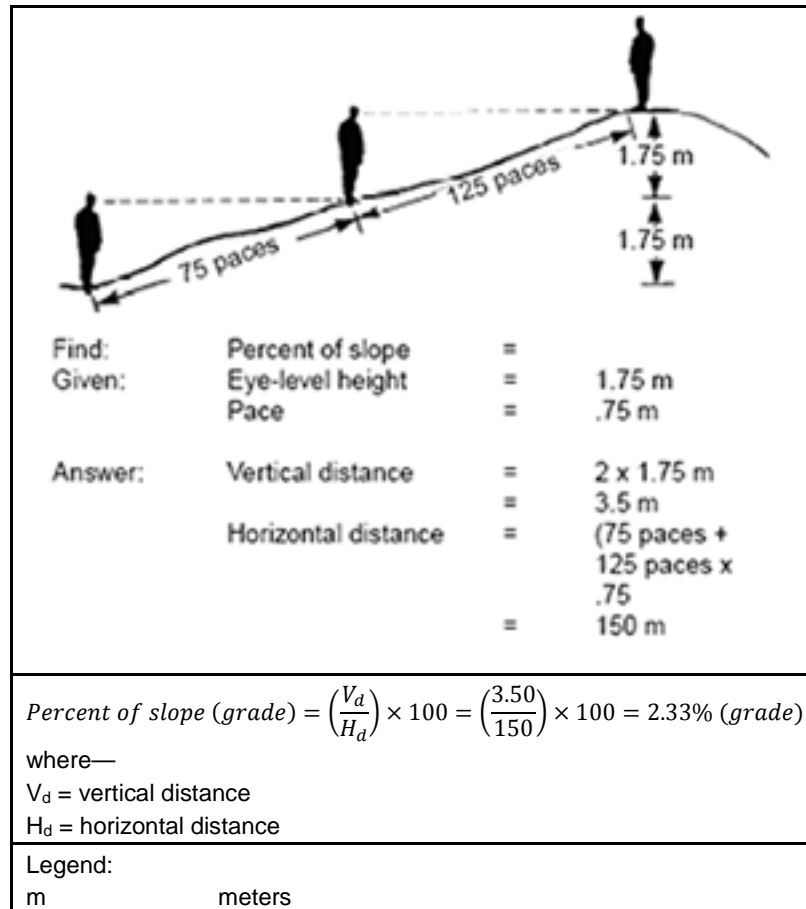

Figure 4-9. Pace method to determine percent of slope

Angle-of-Slope Method

4-32. The angle-of-slope method is a quick way to estimate the percent of slope. The angle of slope is first measured by using an elevation quadrant, an aiming circle, and an M2 compass or binoculars with a standard reticle. If the instrument used to take the angle of measurement is mounted above ground level, the height difference must be compensated for by sighting a corresponding, equal distance above the slope. The corresponding distance is the distance the instrument is above the ground. Obtain the angle of measurement at the base of the slope. (See figure 4-10.) Once angle of measurement is obtained, enter the column corresponding to the measured angle or percent of the slope on table 4-3.

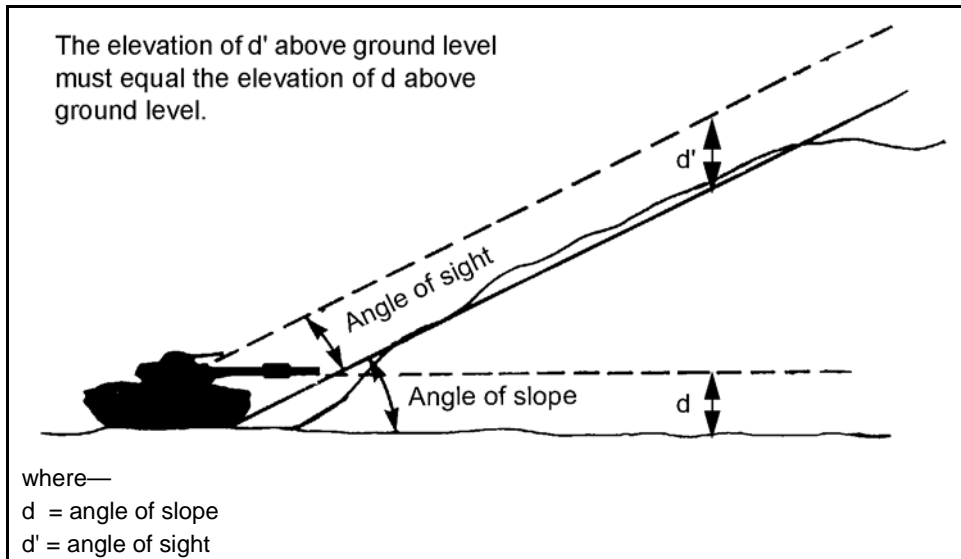

Figure 4-10. Angle-of-slope method to determine percent of slope

Table 4-3. Conversion of degrees and mils to percent of slope

<i>Degrees of Slope</i>	<i>Mils of Slope</i>	<i>Percent of Slope</i>
1	18	1.7
2	36	3.5
3	53	5.2
4	71	7.0
5	89	8.7
10	175	17.6
15	267	26.7
20	356	36.4
25	444	46.6
30	533	57.7
35	622	70.0
40	711	83.9
45	800	100.0
50	889	108.7
55	978	117.6
60	1,067	126.7

Slope Symbols

4-33. Most vehicles negotiating slopes of 7 percent or greater for a significant distance will be slowed. Such slope characteristics must be accurately reported. The symbols illustrated in figure 4-11, page 4-14, are used to represent various slopes.

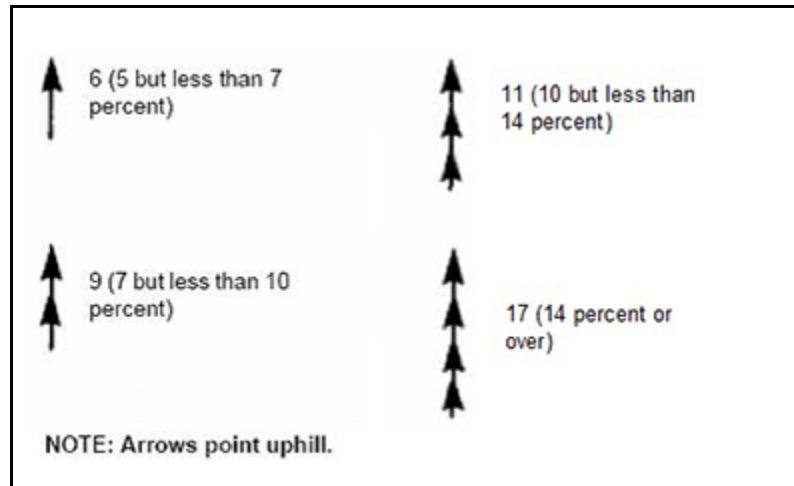

Figure 4-11. Percent-of-slope symbols

4-34. A single arrowhead along the trace of a route pointing in the uphill direction indicates a grade of at least 5 percent, but less than 7 percent. Two arrowheads represent a grade of at least 7 percent, but less than 10 percent. Three arrowheads represent a grade of at least 10 percent, but less than 14 percent. Four arrowheads represent a grade of 14 percent or more. A symbol is not required for slopes less than 5 percent.

4-35. The percent of slope is written to the right of the arrow. (See figure 4-11.) When the map scale permits, the length of the arrow shaft will be drawn to map scale to represent the approximate length of the grade.

Note. Slopes of 7 percent or greater are obstructions to traffic flow and are indicated by OB on the route classification format.

CONSTRICTIONS

4-36. Constrictions are reduced traveled-way widths that may include narrow streets in built-up areas, drainage ditches, embankments, and war damage. These constrictions may also limit vehicle movement.

4-37. Constrictions in the traveled-way width below minimum requirements are depicted on maps and overlays by two opposing shaded triangles. The width of the usable traveled way (in meters) is written next to the left triangle. The length of the constriction along the route is written (in meters) next to the right triangle. (See figure 4-12.)

Note. Constrictions of traveled-way widths below the minimum standard for the type and flow of traffic are obstructions and are indicated by the annotation OB in the route classification format.

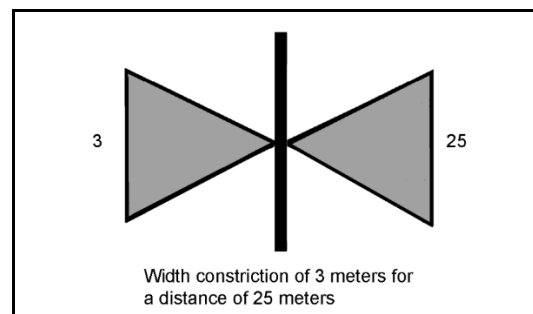

Figure 4-12. Route construction symbol

UNDERPASSES

4-38. An underpass is depicted on a map or overlay by a symbol that shows the structure ceiling. It is drawn over the route at the map location. The width is written (in meters) to the left of the underpass symbol, and the overhead clearance is written (in meters) to the right of the underpass symbol. (See figure 4-13).

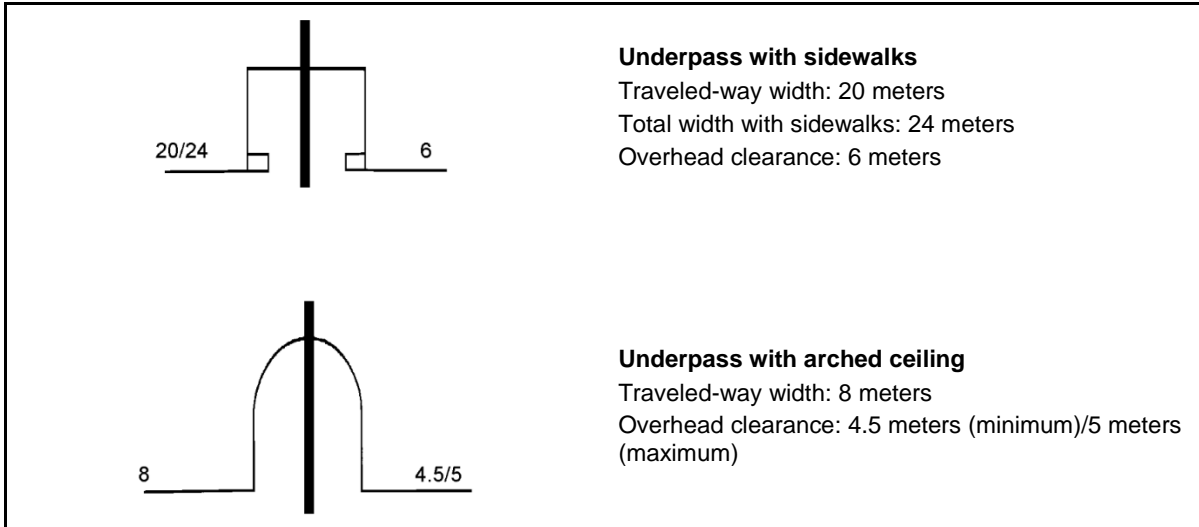

Figure 4-13. Underpass symbols

4-39. If sidewalks permit emergency passage of wider vehicles, the sidewalks are symbolically represented. This information should be noted on DD Form 3012. (See appendix B.) The traveled-way width is recorded first, followed by a slash; then the structure total width, including the sidewalks, is recorded.

CAUTION

Structures with arched ceilings or other ceiling irregularities that result in a decrease in overhead clearance must be noted. In such cases, an extension of width may not mean that the structure will accommodate wider vehicles.

4-40. Minimum and maximum overhead clearances, if different, will be recorded. The minimum overhead clearance is recorded first, followed by a slash; then the maximum overhead clearance is recorded.

TUNNELS ON ROUTES

4-41. A tunnel on a route is an artificially covered structure (covered bridge, snowshed) or an underground section of road along a route. A tunnel reconnaissance determines essential information, to include—

- Serial number.
- Location.
- Type.
- Length.
- Width (including sidewalks).
- Bypasses.
- Alignment.
- Gradient.
- Cross section.

4-42. Tunnel reconnaissance is reported on DD Form 3012. (See appendix B.) A tunnel consists of a bore, a tunnel liner, and a portal. Common shapes of tunnel bores are square with an arched ceiling, elliptical, horseshoe, and semicircular. (See figure 4-14.)

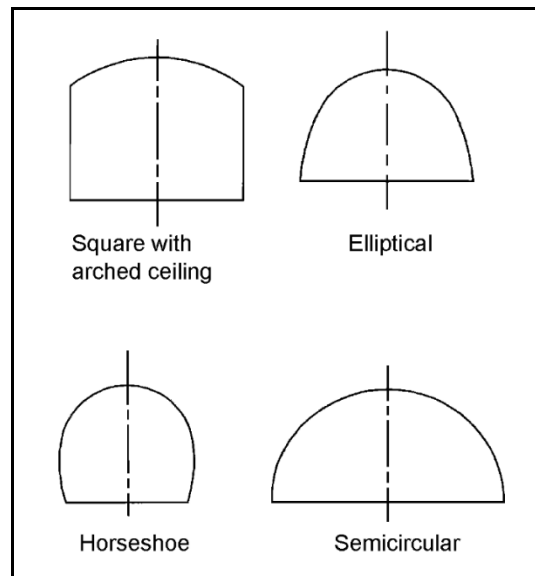

Figure 4-14. Types of tunnel bores

4-43. Basic tunnel information is recorded on maps or overlays using symbols. (See figure 4-15.) The location of the tunnel entrance is shown on a map or overlay by an arrow to the location of the entrance. For long tunnels (greater than 30.5 meters), both tunnel entrance locations are indicated.

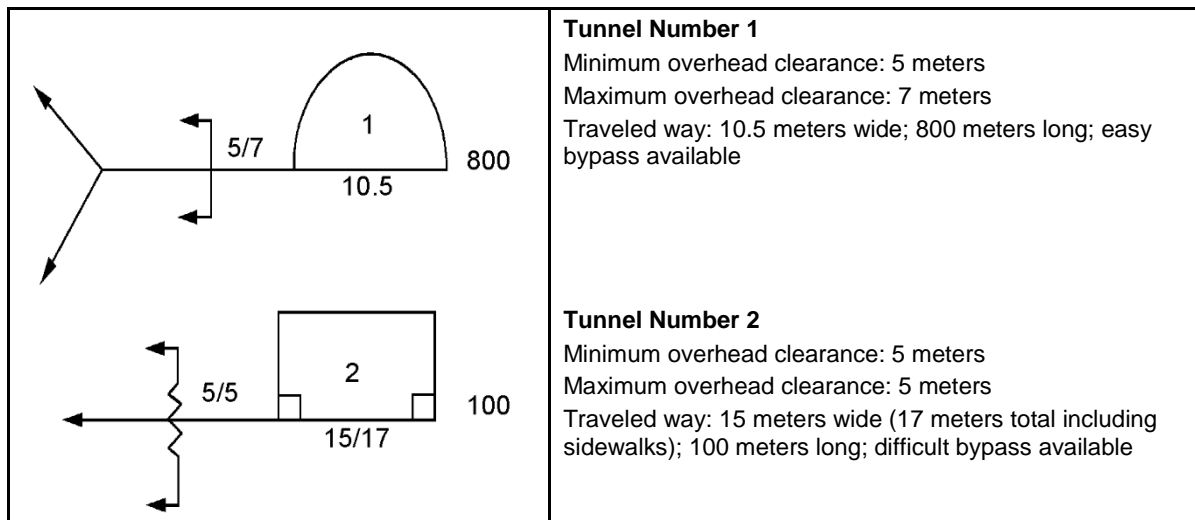

Figure 4-15. Tunnel symbols

4-44. For later reference, a serial number is assigned to each tunnel. Check for an existing fixed serial number on the actual tunnel or map sheet. If the tunnel does not have a serial number, assign a serial number based on the unit SOP. Serial numbers are not duplicated on any one map sheet, overlay, or document. The number is recorded inside the symbol. The traveled-way width is shown in meters, and it is placed below the symbol.

4-45. If sidewalks permit the emergency passage of wider vehicles, then the sidewalks are symbolically represented. The traveled-way width is recorded first, followed by a slash; then the total width, including the sidewalks, is recorded.

CAUTION

Structures with arched or irregular ceilings will decrease overhead clearance. An extension of width does not always mean that the structure will accommodate wider vehicles.

4-46. The overhead clearance is the shortest distance between the surface of a traveled way and any obstruction vertically above the traveled way. The measurement of overhead clearance must be accurate. Obtain the measurements as shown in figure 4-16 and figure 4-17, page 4-18. Record the measurements on DD Form 3012.

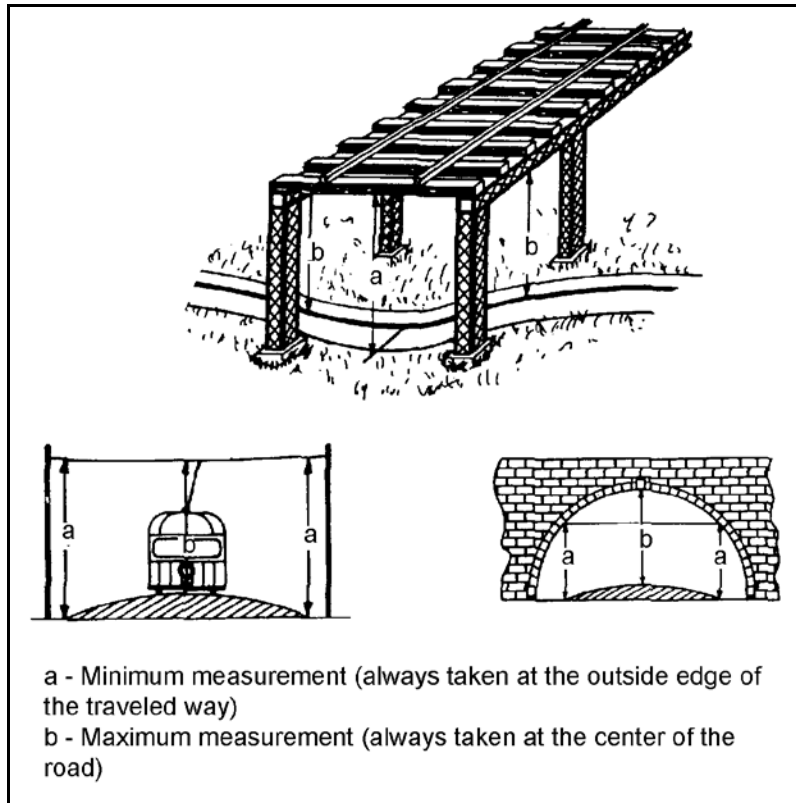

Figure 4-16. Overhead clearance measurements

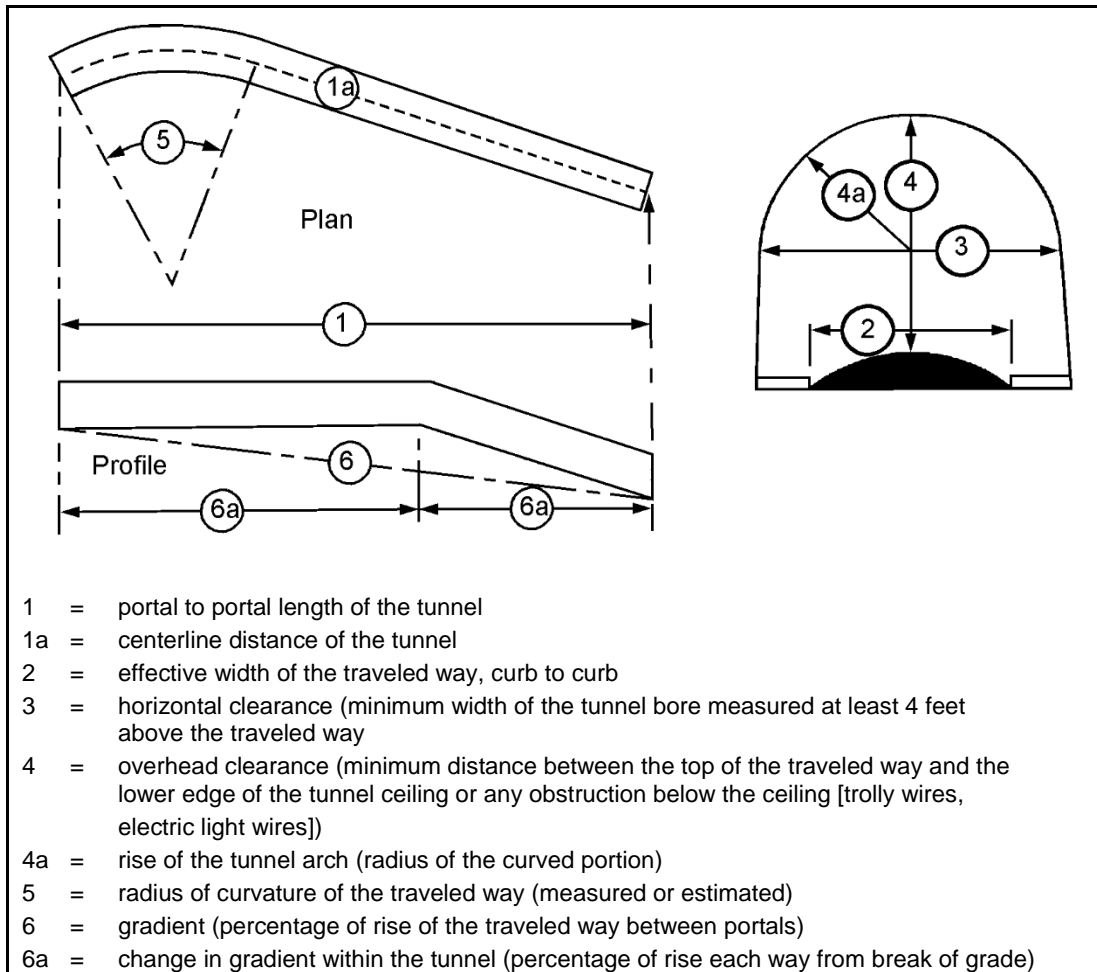

Figure 4-17. Dimensions required for tunnels

4-47. The reconnaissance element records a general description and sketch of the tunnel entrances (portals) and the composition. The portal view information and sketch are recorded on DD Form 3012. (See figure 4-18.)

ROAD RECONNAISSANCE

4-48. A road reconnaissance collects detailed technical information on the engineering characteristics and trafficability of a road or road section within a route. Report the results of a road reconnaissance on DD Form 3010. In general, a road consists of a road surface, base course, and subgrade. (See figure 4-19.)

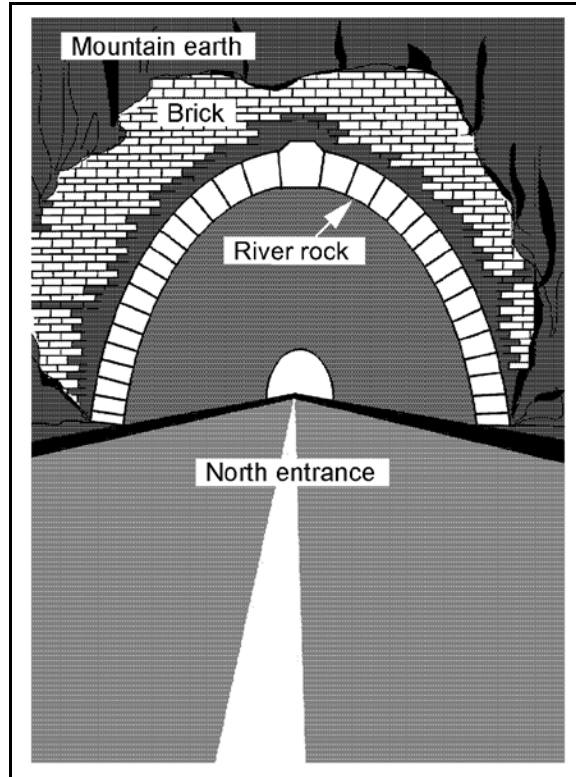

Figure 4-18. Portal view of tunnel

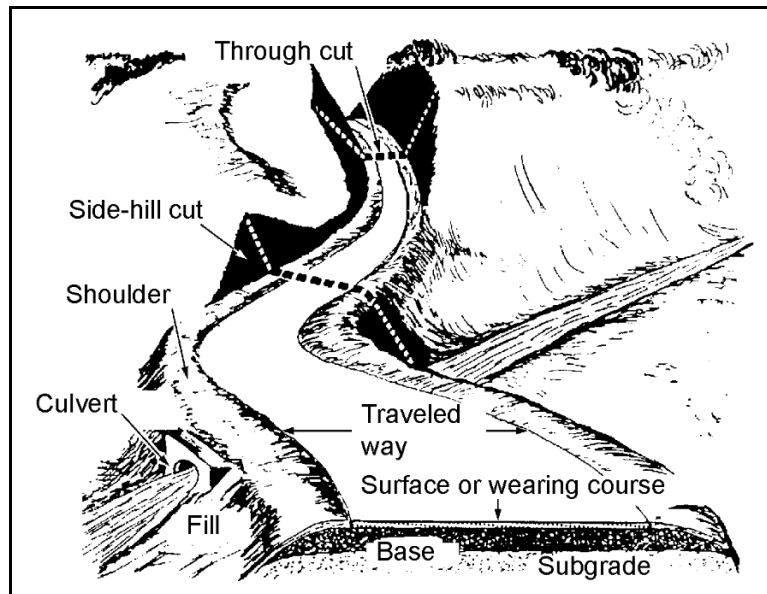

Figure 4-19. Parts of a road

4-49. Identifying the soil type used in road construction is a critical component of the road reconnaissance. Soils, stabilized when necessary, form the subgrade and base course for the vast majority of roads. Soils are considered according to type, characteristics, and allowable foundation bearing pressure. Soil types range from gravel and sandy soils to clay and silty soils. The principal soil type is described in table 4-4, page 4-20, and those characteristics are further analyzed in table 4-5, page 4-21, including an allowable bearing pressure.

The allowable bearing pressure is expressed as a California bearing ratio, which is used to determine the load-bearing capacity of a flexible road surface.

Note. The California bearing ratio is a measure of the shearing resistance of soil under controlled density and moisture conditions. (See figure 4-20, page 4-22.) It is expressed as a ratio of the unit load required to force a piston into the soil to the unit load required to force the same piston the same depth into standard crushed stone.

Table 4-4. Principle soil types

Name	Description
Gravel	Gravel is a mass of detached rock particles, generally water worn. Gravel passes a 3-inch sieve, and it is retained on a Number 4 sieve (0.187 inches).
Sand	Sand is a granular material that is composed of rock particles. The rock particles can pass a Number 4 sieve (0.187 inches), but they are retained on a Number 200 sieve (0.0029 inches). It is difficult to distinguish sand from silt when the particles are uniformly small. Dried sand, however, differs from silt; it has no cohesion and feels grittier.
Silt	Silt is a fine, granular material composed of particles that can pass the Number 200 sieve (0.0029 inches). It lacks plasticity, and it has little dry strength. To identify silt, prepare a pat of wet soil and shake it horizontally in the palm of your hand. With typical inorganic silt, shaking causes water to come to the surface of the sample, making it appear glossy and soft. Repeat the tests with varying moisture contents. Squeezing the sample between your fingers causes the water to disappear from the surface, and the sample quickly stiffens and finally cracks or crumbles. Allow the sample to dry, test its cohesion, and feel it by crumbling it with your fingers. Typical silt shows little or no dry strength, and it feels only slightly gritty in contrast to the rough grittiness of fine sand.
Clay	Clay is an extremely fine-grained material composed of particles that can pass the Number 200 sieve (0.0029 inches). To identify clay, work a sample with your fingers, adding water when stiffness requires it. The moist sample should be plastic enough to be kneaded like dough. Test it further by rolling a ball of kneaded soil between the palm of your hand and a flat surface. Clay can be rolled to a slender thread, about 1/4 inch in diameter, without crumbling; silt crumbles without forming a thread. Measure the hardness of dry clay by the finger pressure required to break a sample. It requires much greater force to break dry clay than dry silt. Clay feels smooth in contrast to the slight grittiness of silt.
Organic	Organic soil is composed of decayed or decaying vegetation, sometimes mixed with fine-grained mineral sediments (peat, muskeg). It is identified by a coarse and fibrous appearance and odor. The odor may be intensified by heating. Plastic soils containing organic material can be rolled into soft, spongy threads.

Table 4-5. Soil characteristics of roads and airfields

Major Divisions		Letter	Name	Field CBR	
Coarse-grained soils	Gravel and gravelly soils	GW	Well-graded gravels or gravel-sand mixtures, little or no fines	60-80	
		GP	Poorly graded gravels or gravel-sand mixtures, little or no fines	25-60	
		GM	d ¹	Silty gravels, gravel-sand-silt mixtures	40-80
			u ²		20-40
	GC	Clayey gravels, gravel-sand-clay mixtures	20-40		
	Sand and sandy soils	SW	Well-graded sands or gravelly sands, little or no fines	20-40	
		SP	Poorly graded sands or gravelly sands, little or no fines	10-25	
		SM	d ¹	Silty sands, sand-silt mixtures	20-40
u ²			10-20		
SC	Clayey sands, sand-clay mixtures	10-20			
Fine-grained soils	Silts and clays (liquid limits <50)	ML	Inorganic silts and very fine sands, rock flour, silty or clayey fine sands, or clayey silts with slight plasticity	5-15	
		CL	Inorganic clays of low to medium plasticity, gravelly clays, sandy clays, silty clays, lean clays	5-15	
		OL	Organic silts and organic silt-clays of low plasticity	4-8	
	Silts and clays (liquid limits >50)	MH	Inorganic silts, micaceous or diatomaceous fine sandy or silty soils, elastic silts	4-8	
		CH	Inorganic clays of high plasticity, fat clays	3-5	
		OH	Organic clays of medium to high plasticity, organic silts	3-5	
	Highly organic soils	Pt	Peat and other highly organic soils		
<p>Note. Division of GM and SM groups into subdivisions of d¹ and u² are for roads and airfields only; the subdivision is a basis of the Atterberg limits.</p> <p>¹Indicates liquid limit is 28 or less, and plasticity index is 6 or less.</p> <p>²Indicates liquid limit is 28 or greater.</p>					
<p>Legend: CBR California bearing ratio</p>					

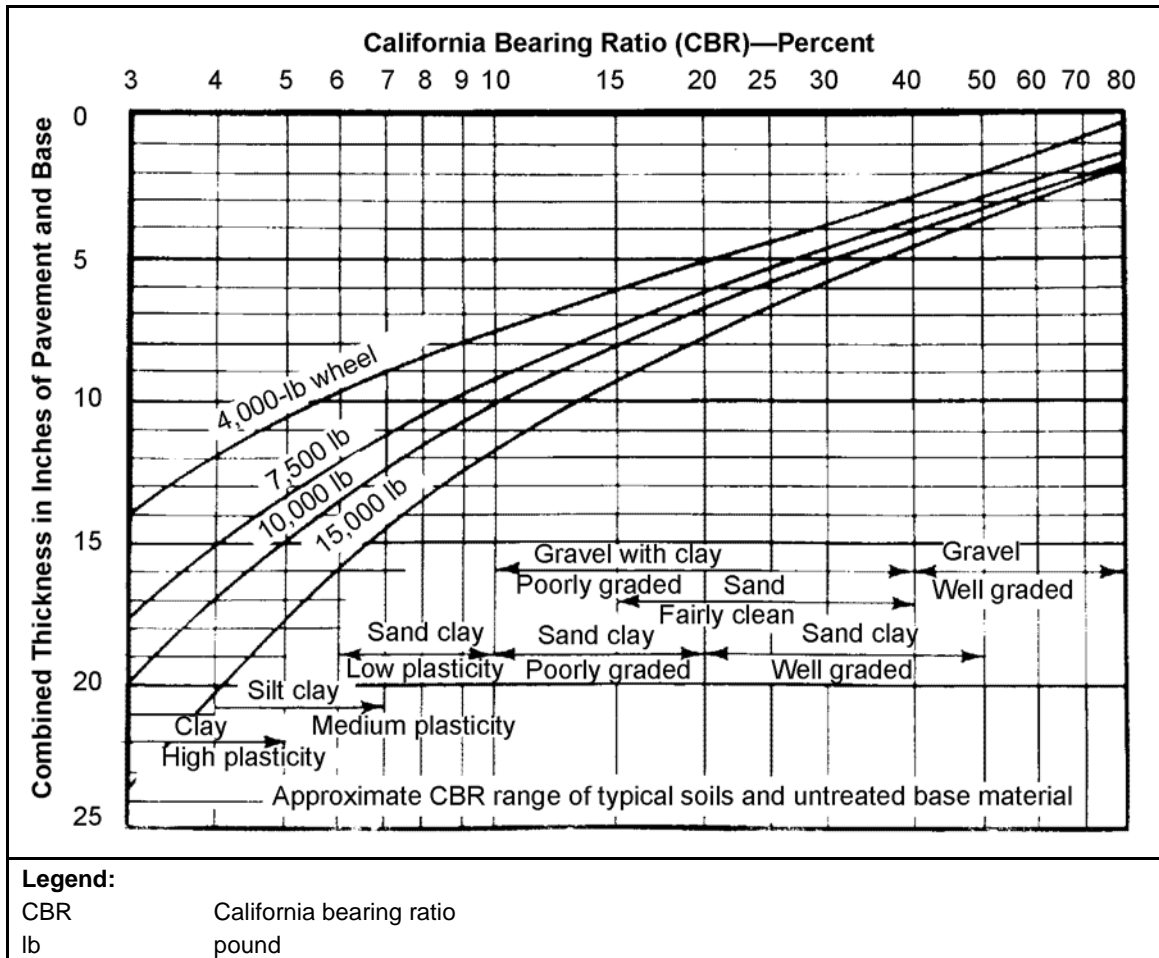

Figure 4-20. Load bearing capacity of roads with a flexible surface

BASE COURSE AND SUBGRADE

4-50. The base course and subgrade are the intermediate fill under the traveled surface of the roadway. Base courses are usually composed of gravel or crushed rock. Subgrade soils are typically more silts and clay soils. Table 4-6 cross-references various engineering properties of soils to the soil letter designator.

ROAD CAPACITY AND COMPUTATIONS

4-51. The load-bearing capacity of a road is its ability to support traffic, and it is expressed by an MLC. The load-bearing capacity of a road with a flexible surface describes its ability to support traffic, and it is expressed initially as a maximum allowable wheel load and then converted to an equivalent MLC. After determining the type of subgrade material of the road using table 4-4, page 4-20; table 4-5, page 4-21; and table 4-6; an accurate estimation of the load-bearing capacity of a road for wheeled vehicles can be made by measuring the combined thickness of the surface and base course. Then use figure 4-20 to obtain the corresponding load bearing capacity in pounds. The load-bearing capacity determined in figure 4-20 is expressed as a maximum allowable wheel load in pounds. See table 4-7, page 4-24, to convert the bearing capacity in pounds to an equivalent MLC. Road classification for tracked vehicles is not normally assigned. Usually, other factors (such as wear and tear on the road surface by track action) determine the road capacity to support track vehicles.

Table 4-6. Engineering properties of soil types

Letter		Value as Foundation when Not Subject to Frost Action ³	Value as Base Directly Under Bituminous Pavement	Potential Frost Action ⁴	Compressibility and Expansion	Drainage Characteristics
GW		Excellent	Good	None to very slight	Almost none	Excellent
GP		Good to excellent	Poor to fair	None to very slight	Almost none	Excellent
GM	d ¹	Good to excellent	Fair to good	Slight to medium	Very slight	Fair to poor
	u ²	Good	Poor	Slight to medium	Slight	Poor to practically impervious
GC		Good	Poor	Slight to medium	Slight	Poor to practically impervious
SW		Good	Poor	None to very slight	Almost none	Excellent
SP		Fair to good	Poor to not suitable	None to very slight	Almost none	Excellent
SM	d ¹	Good	Poor	Slight to high	Very slight	Fair to poor
	u ²	Fair to good	Not suitable	Slight to high	Slight to medium	Poor to practically impervious
SC		Fair to good	Not suitable	Slight to high	Slight to medium	Poor to practically impervious
CL		Fair to poor	Not suitable	Medium to high	Medium	Practically impervious
OL		Poor	Not suitable	Medium to high	Medium to high	Poor
MH		Poor	Not suitable	Medium to high	High	Fair to poor
CH		Poor to very poor	Not suitable	Medium	High	Practically impervious
OH		Poor to very poor	Not suitable	Medium	High	Practically impervious
Pt		Not suitable	Not suitable	Slight	Very high	Fair to poor

¹Indicates liquid limit is 28 or less, and plasticity index is 6 or less.
²Indicates liquid limit is 28 or greater.
³Values are for subgrades and base courses except for base courses directly under bituminous pavement.
⁴Indicates whether these soils are susceptible to frost.

4-52. If the MLC of the road is greater than the classification of the weakest bridge on the route, the bridge classification determines the capacity of the route. After determining the type of subgrade material, an accurate estimation of the load-bearing capacity of a road for wheeled vehicles can be made by measuring the combined thickness of the surface and base course. Use figure 4-20 to obtain the corresponding load-bearing capacity in pounds. Some pavement sections may include a sand (depicted as start point [SP]) subbase material between the base course and a silt or clay subgrade. The thickness of the SP can be included in the calculations for the combined thickness in inches of pavement and base in figure 4-20.

Table 4-7. Wheeled vehicle classification related to single wheel load

<i>Classification number</i>	<i>Maximum single wheel load (pounds)</i>
4	2,500
8	5,500
12	8,000
16	10,000
20	11,000
24	12,000
30	13,500
40	17,000
50-150	20,000

ROAD CLASSIFICATION FORMAT

4-53. The road classification format is a systematic description of the limiting section of a road. Do not confuse it with the route classification format. Recorded information from the road classification format is included in the route classification format. The following describes each portion of the format:

- (1) Prefix the format with A if there are no limiting characteristics or B if there is one or more limiting characteristics.
- (2) Limiting characteristics represent an unknown or undetermined characteristic with a question mark, together with the feature to which it refers. (See table 4-8.)
- (3) Minimum traveled-way width is expressed with width in meters followed by a slash and the combined width of the traveled way and the shoulders.
- (4) Road surface material is expressed with a letter symbol. The format above describes the surface material as water-bound macadam. Use the symbols listed in table 4-9. They are further related to the X, Y, and Z route types of the route classification described earlier in paragraph 4-10.
- (5) Road length is expressed in kilometers and placed in parentheses.
- (6) Indicate obstructions along a road by placing the symbol OB after the road length. Details of the obstructions are not shown in the format; they are reported separately by appropriate symbols on accompanying maps, overlays, or DD Form 3010. Report the following obstructions:
 - Overhead obstructions (less than 4.3 meters over the route).
 - Constrictions in traveled-way widths less than 6 meters for single-flow traffic or less than 8 meters for double-flow traffic (tracked or combination vehicles [see table 4-2, page 4-6]).
 - Slopes of 7 percent or greater.
 - Curves with a radius of less than 25 meters (report curves of 25.1 to 45 meters).
- (7) If blockage is regular, recurrent, and serious, the effects of snow blockage and flooding are indicated in the road classification report. Use T to indicate snow blockage, and use W to indicate frequent flooding.

Note. Use this example format for the road classification report.

(1) / (2) / (3) / (4) / (5) / (6) / (7)

B / g s / 4/5 / r / (8 km) / (OB) / (T)

Table 4-8. Symbols for limiting characteristics

<i>Limiting Characteristics</i>	<i>Criteria</i>	<i>Symbol</i>
Sharp curves	Sharp curves with a radius of 25 meters or less	c
Steep gradients	Steep gradients, 7% or steeper (such as gradients)	g
Poor drainage	Inadequate ditches, crown or camber, or culverts; culverts and ditches blocked or otherwise in poor condition	d
Weak foundation	Unstable, loose, or easily displaced material	f
Rough surface	Bumpy, rutted, or potholed to an extent likely to reduce convoy speeds	s
Excessive camber or superelevation	Falling away so sharply as to cause heavy vehicles to skid or drag toward shoulders	j

Table 4-9. Symbols for type of surface materials

<i>Symbol</i>	<i>Material</i>	<i>Route Type</i>
K	Concrete	Type X; generally heavy duty
kb	Bituminous (asphaltic) concrete (bituminous plant mix)	Type X; generally heavy duty
P	Paving brick or stone	Type X or Y; generally heavy duty
Pb	Bituminous surface on paving brick or stone	Type X or Y; generally heavy duty
rb	Bitumen-penetrated macadam, water-bound macadam with superficial asphalt or tar cover	Type X or Y; generally medium duty
r	Water-bound macadam, crushed rock or coral or stabilized gravel	Type Y; generally light duty
L	Gravel or lightly metaled surface	Type Y; generally light duty
nb	Bituminous surface treatment on natural earth, stabilized soil, sand-clay, or other select material	Type Y or Z; generally light duty
b	When type of bituminous construction cannot be determined	Type Y or Z; generally light duty
n	Natural earth stabilized soil, sand-clay, shell, cinders, disintegrated granite, or other select material	Type Z; generally light duty
V	Various other types not mentioned above	Classify X, Y, or Z depending on the type of material used (indicate length when this symbol is used).
Legend:		
X	all weather	
Y	limited, all weather	
Z	fair weather	

4-54. A sample DD Form 3010 is shown in appendix B. (See table 4-10 for examples of the road classification format.)

Table 4-10. Examples of the road classification format

Road Classification Format	Description
A 5.0/6.2	A road with no limiting characteristics or obstructions, a minimum traveled way of 5.0 meters, a combined width of traveled way and shoulders of 6.2 meters, and a concrete surface.
B g s 4/5 L (OB)	A road with limiting characteristics of steep gradients and a rough surface, a minimum traveled way of 4 meters, a combined width of 5 meters, gravel or light metal surfaces, and obstructions.
B c (f?) 3.2/4.8 P (4.3km) (OB) (T)	A road with limiting characteristics of sharp curves and unknown foundation, a minimum traveled way of 3.2 meters, a combined width of 4.8 meters, paving brick or stone surface, obstructions, and 4.3 kilometers long subject to snow blockage.
Legend:	
A	no limiting characteristics
B	limiting characteristics
km	kilometers
OB	obstruction
P	pedestrian
T	tracked

Notes.

1. Where rockslides are a hazard or poor drainage is a problem, include information on a written enclosure or legend.
 2. Ensure that a new classification format is entered on DD Form 3010 each time the road changes significantly.
-

Chapter 5

Technical Reconnaissance—Assessments and Surveys

The ERTs conduct reconnaissance but may include all or key portions of an assessment as part of the specified focus of technical information. Assessments may be conducted as an integrated requirement in the reconnaissance or may be in support of information requirements at the operational level. Typically, engineer surveys are conducted at the operational level. Operational-level assessments and survey teams employ a routinely high degree of technical expertise. Survey teams are focused on the technical requirements of the reconnaissance support mission. The capabilities in both cases overlap substantially, but the overall nature of the engineer reconnaissance support is distinct. This chapter discusses assessment and survey capabilities and those assessment capabilities available from ERTs. Regardless of the level of reconnaissance support integration when operating within assigned maneuver areas, the assessment or survey team must fully coordinate their activity with the maneuver unit.

BRIDGE RECONNAISSANCE

5-1. A bridge reconnaissance is conducted to collect detailed technical information on selected bridges. The bridge reconnaissance is conducted as part of a route or road classification or as a separate mission focused on the selected bridge. Based on the situation, the reconnaissance may be conducted by an ERT, an augmented ERT, an assessment team, or a survey team. The level of detail of the information collected will increase in the progression from ERT to survey team. In every case, the information collected can be used to determine the bridge load-carrying capacity and to estimate resources required to repair or upgrade the bridge. The ERTs also conduct bridge reconnaissance to collect information to enable the planning and estimation of the materials required for a bridge demolition. See FM 3-34.214/MCRP 3-17.7L for additional information on bridge demolition requirements. DD Form 3011 is used to report the information collected from a bridge reconnaissance.

5-2. Large, multilane highway bridges are common in most theaters of operations. These bridges with steel girders or prestressed concrete beams may be difficult to classify. Damaged bridges will also present a challenge for classification, resulting from the damage and for repair options to mitigate the damage. The U.S. Army Corps of Engineers and Naval Facilities Engineering Command have developed specific expertise to assist in assessing bridges that present a challenge to reconnaissance elements in the field. The assistance is available through reachback support via the U.S. Army Corps of Engineers, Reachback Operations Center.

BRIDGE CONDITION

5-3. The reconnaissance team collects general information and assesses the general condition of the bridge, paying particular attention to evidence of damage from natural causes (rot, rust, deterioration) or combat action. Classification procedures presume that a bridge is in good condition. If the bridge is in poor condition, the classification obtained from mathematical computations must be reduced according to the classifier's judgment. See TM 3-34.22/MCRP 3-17.1B for a complete discussion of bridge classification procedures and signing of a bridge. The bridge assessment provides the basic MLC information necessary for the commander to plan for the use of the bridge.

BRIDGE SYMBOL

5-4. The reconnaissance team collects the specific bridge information necessary to fill out the full North Atlantic Treaty Organization (NATO) bridge symbol. (See TM 3-34.22/MCRP 3-17.1B.) This symbol is

different from an on-site bridge classification. The information necessary for the full bridge symbol includes the—

- Bridge serial number.
- Geographic location.
- Bridge MLC.
- Overall length.
- Traveled-way width.
- Overhead clearance.
- Available bypasses.

5-5. A bridge serial number is assigned for future reference, and it is recorded in the lower portion of the symbol (assign a number according to the unit SOP). For proper identification, do not duplicate serial numbers within any one map sheet, overlay, or document.

5-6. A telltale or other warning device is placed before the bridge to indicate overhead clearance limitations. (See figure 5-1.) A question mark is used to indicate information that is unknown or undetermined and is included as part of the bridge reconnaissance symbol.

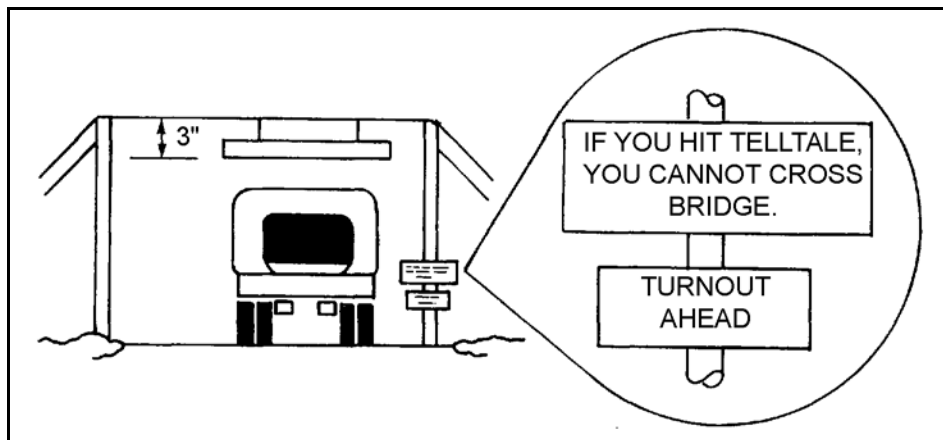

Figure 5-1. Telltale

5-7. The reconnaissance team may be interested in railway bridges that could be used by other vehicles in an emergency. The team conducts a bridge reconnaissance and makes an overall assessment of the adaptability of the railway bridge for vehicle traffic indicating *use easy* or *use difficult* on the bridge symbol. A railroad bridge is considered easy to adapt for use if it can be adapted in less than 4 hours with 35 Soldiers/Marines and the appropriate resources.

OTHER GAP-CROSSING SITES

5-8. Like bridges, the range of engineer reconnaissance capabilities is employed to collect detailed technical information on gap-crossing sites where bridges are not present. Similar to bridge reconnaissance, reconnaissance of gap-crossing sites is conducted to collect detailed technical information where bridges are not present. It is typically conducted as part of a route or road classification or as a separate evolution directed toward collection at a selected site. Based on the situation, the reconnaissance may be conducted by an ERT, an augmented ERT, an assessment team, or a survey team. The level of detail of the information collected increases in the progression from ERT to survey team. The information collected is used to determine the route classification and to estimate resources for repair or upgrade of the site or for construction of a bridge at the site. There are several forms used to record and report the information collected during reconnaissance of gap-crossing sites. Appendix B provides detailed instructions for their use.

FORD RECONNAISSANCE

5-9. A ford is a location in a water barrier where the current, bottom, and approaches allow personnel, vehicles, and other equipment to cross and remain in contact with the bottom during crossing. Fords are obstructions to traffic flow. Detailed ford reconnaissance information is recorded on DD Form 3013. (See appendix B.)

5-10. During high-water periods, low-water bridges are easily confused with paved fords because they are completely submerged. It is important to know the difference between this type of bridge and a paved ford because of corresponding military load limitations.

5-11. Fords are classified according to the crossing potential (or trafficability) for pedestrians or vehicles. Fordable depths for vehicular traffic can be increased by suitable waterproofing and adding deepwater fording kits. Check vehicle technical manuals for fording capabilities.

5-12. Record the composition of the approaches. They may be paved or covered with mat or trackway, but they are usually unimproved. The composition and the slope of the approaches to a ford should be carefully noted to determine the trafficability after fording vehicles saturate the surface material of the approaches. Identify the ford left and right approaches when looking downstream.

5-13. Record the current velocity and the presence of debris to determine the effect, if any, on the ford condition and passability. Estimate the current as—

- Swift (more than 1.5 meters per second).
- Moderate (1 to 1.5 meters per second).
- Slow (less than 1 meter per second).

5-14. The ford bottom composition largely determines its trafficability. It is important to determine whether the bottom is composed of sand, gravel, silt, clay, or rock and in what proportions. Record whether the natural river bottom of the ford has been improved to increase the load-bearing capacity or to reduce the water depth. Improved fords may have gravel, macadam, or concrete surfacing; layers of sandbags; metal screening or matting; or timber (corduroy) planking. Nearby material may be used to improve the ford. Record the ford limitation information on maps or overlays using a symbol as shown in figure 5-2, page 5-4. The information recorded should include—

- **Geographic location.** The geographic location of the ford is shown by an arrow from the symbol to the ford location on a map or overlay. The symbol is drawn on either side of the stream.
- **Serial number.** A serial number is assigned to each ford for reference (if the ford already has an assigned serial number on the map sheet, use it). Follow the unit SOP in assigning serial numbers. They must not be duplicated within any one map sheet, overlay, or document.
- **Ford type.** The type of ford is determined by bottom conditions, width, and water depth. Use the letters V for vehicular or P for pedestrian to show the ford type. Approaches are not considered in determining the ford type.
- **Stream velocity.** The normal stream velocity is expressed in meters per second. Seasonal limiting factors follow the stream velocity notation and are shown by the following letter designation:
 - **X.** No seasonal limitations except for sudden flooding of limited duration (such as flash floods).
 - **Y.** Serious, regular, or recurrent flooding or snow blockage. If symbol Y is used, the route type in the route classification format automatically becomes type Z.
- **Ford length.** The ford length, expressed in meters, is the distance from the near to far shores. The width of the ford is the traveled-way width of the ford bottom.
- **Ford bottom.** The nature of the bottom is indicated by the most appropriate letter designation:
 - M = mud.
 - C = clay.
 - S = sand.
 - G = gravel.

- R = rock.
- P = artificial paving.
- **Depth.** The normal depth is the depth of water at the deepest point, expressed in meters. During a hasty reconnaissance, the actual water depth is used.
- **Stream banks.** The left and right banks of a stream are found by looking downstream. From the middle of the stream and looking downstream, your left arm indicates the left bank and your right arm indicates the right bank. In drawing this portion of the symbol, pay attention to the direction of the stream flow. A difficult approach is shown by irregular lines placed on the corresponding side of the basic symbol.

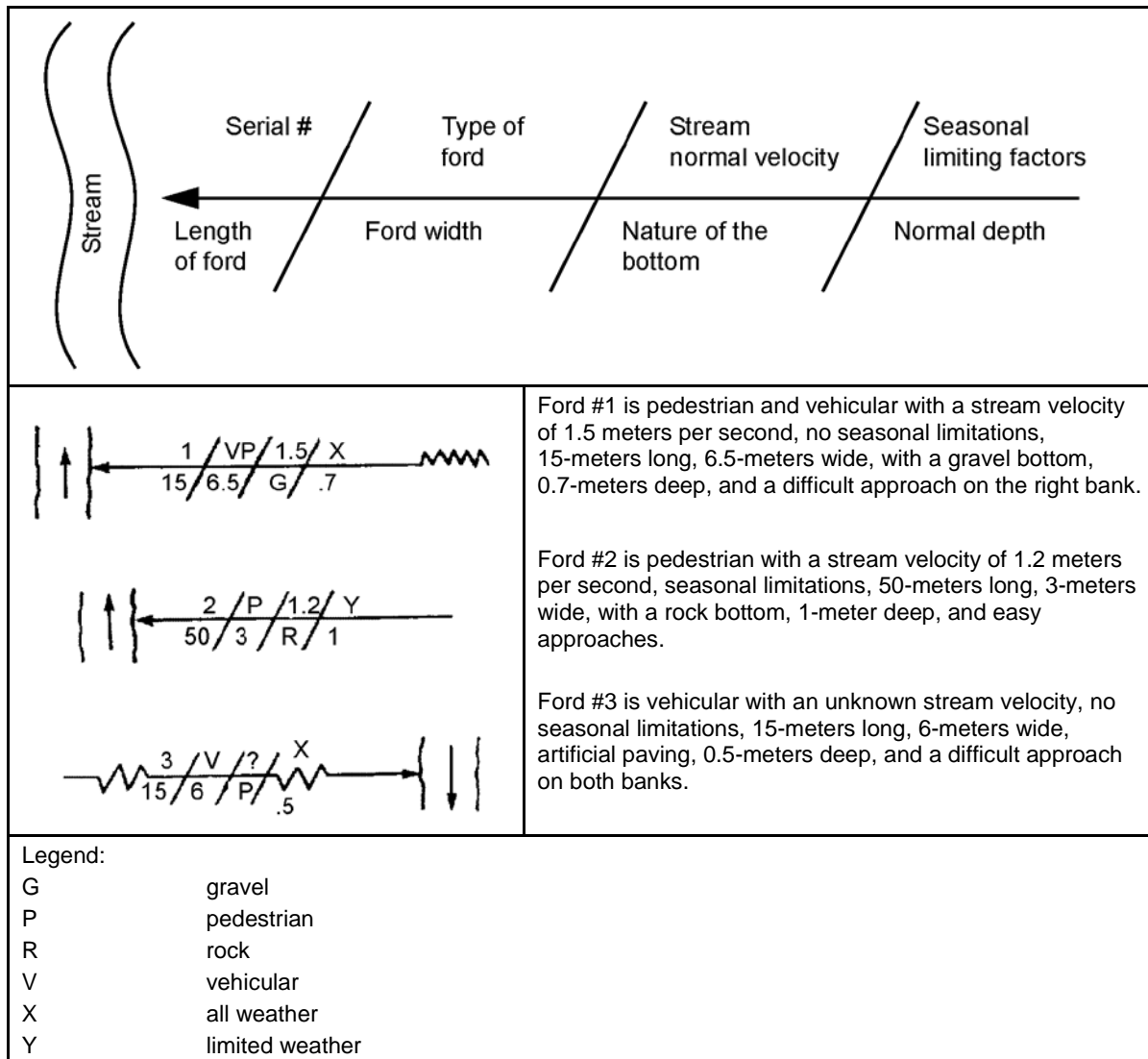

Figure 5-2. Ford symbols

5-15. All elements of the ford symbol are separated by slashes. If the ford symbol is unknown or cannot be determined, substitute a question mark for the required information.

FERRY RECONNAISSANCE

5-16. Ferries are considered obstructions to traffic flow and are indicated by the letters OB on the route classification format. Ferryboat construction varies widely and ranges from expedient rafts to ocean-going

vessels. Ferries differ in physical appearance and capacity depending on the water width, depth, current, and the characteristics of the traffic to be moved. Ferries may be propelled by oars, cables and pulleys, poles, stream current, or engines (steam, gasoline, or diesel). Detailed ferry reconnaissance information is recorded on DD Form 3014. (See appendix B.)

5-17. Usually, the capacity of a civil ferryboat is expressed in short tons and total number of passengers. The ferry is often assigned an MLC number. Ensure that the capacity of each ferry is recorded when more than one is used at a given site. The ferries may vary in capacity.

5-18. Ferry slips (or piers) are usually provided on each shore to permit easy loading of passengers, cargo, and vehicles. The slips may range from simple log piers to elaborate terminal buildings. A distinguishing characteristic of a ferry slip is often the floating pier that adjusts, with changes in the water depth, to the height of the ferryboat.

5-19. Approach routes to ferry installations have an important bearing on using the ferry. Reconnoitering and recording the conditions of the approaches (including the load-carrying capacity of landing facilities) is very important.

5-20. Limiting characteristics of ferry sites that should be considered are the—

- Width of the water barrier from bank to bank.
- Distance and time required for the ferryboat to travel from one bank to the other.
- Depth of the water at each ferry slip.
- Ease in which each landing site can be defended.

5-21. Climatic conditions affect ferry operations. Fog and ice substantially reduce the total traffic moving capacity and increase the hazard of the water route. As a result, planners should review meteorological data (tidal fluctuations, freezing periods, floods, excessive dry spells, storm seasons) and consider the effect that local weather conditions may have on ferrying.

5-22. Limited ferry information is recorded on maps or overlays by using the symbols shown in figure 5-3, page 5-6. Figure 5-4, page 5-6, gives examples of completed ferry symbols. The information recorded includes the—

- **Geographic location.** The geographic location of the ferry is shown by an arrow from the symbol to the location of the ferry on a map or overlay. The symbol may be drawn on the map or overlay on either side of the stream.
- **Serial number.** A serial number is assigned to each ferry for later reference. The numbers must not be duplicated within any one map sheet, overlay, or document. Some maps will already show a ferry serial number. Use this number for your reconnaissance. If you do not find a number, record a number according to the unit SOP.
- **Ferry type.** The type of ferry (V for vehicular and P for pedestrian) is shown after the serial number. If the ferry can haul vehicles, it can also haul pedestrians.
- **Deck MLC.** The deck MLC is placed in the bottom left box of the symbol. Most ferries have this information on the data plate.
- **Dead-weight capacity.** The dead-weight capacity of the ferry is the MLC plus the actual weight of the ferry in short tons.
- **Turnaround time.** The turnaround time is shown by the number of minutes required to cross the water obstacle, unload, and return.

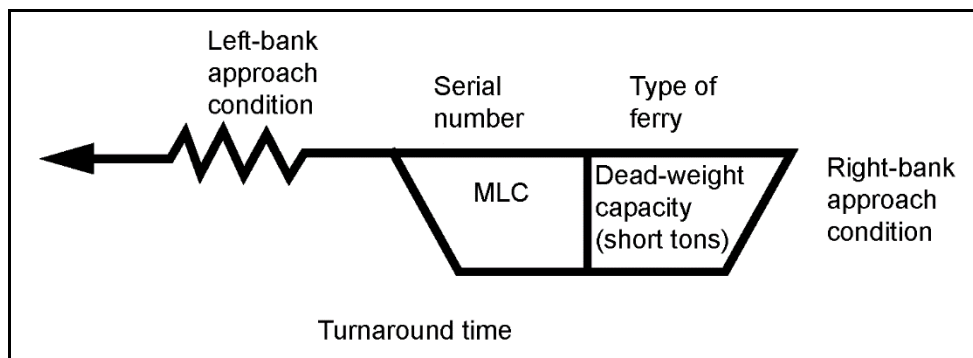

Figure 5-3. Ferry symbols

Ferry #1 is a pedestrian ferry with an MLC deck unknown, 8 short ton dead-weight capacity, 12 minute turnaround time, and a difficult left bank approach.

Ferry #2 is a vehicular and pedestrian ferry with MLC of deck 60, unknown dead-weight capacity, a 20 minute turnaround time, and a difficult right bank approach.

Ferry #3 is a vehicular and pedestrian ferry with MLC of deck 60, 100 short ton dead-weight capacity, 18-minute turnaround time, and difficult approaches on both banks.

Legend:
 MLC military load classification
 P pedestrian
 V vehicular

Figure 5-4. Sample ferry symbols

5-23. When drawing the approach condition portion of the symbol, pay attention to the direction of stream flow. Left and right banks are determined by looking downstream. Approach conditions are determined in the same manner as fords. A difficult approach is shown by irregular lines placed on the corresponding side of the basic symbol. A question mark is substituted for unknown or undetermined information.

RIVER RECONNAISSANCE

5-24. River reconnaissance is conducted to collect and report technical information regarding sites that may be suitable for military rafting or bridging. The data collected can also be used to determine the suitability of sites for fording or swimming. See ATTP 3-90.4/MCWP 3-17.8 for information related to wet and dry gap crossing. Desirable site characteristics are—

- Current velocity between 0 and 1.6 meters per second.
- Banks that permit loading without a great deal of preparation.
- Approaches that permit easy access and egress.
- Strong, natural anchorage or holdfasts.
- Sites with no shoals, sandbars, or snags.
- Sites clear of obstacles immediately downstream.

- Sites clear of mines and booby traps.
- Sites with enough depth to prevent grounding the raft during loading and unloading operations or when crossing.
- Suitable raft-construction sites (depending on the type of raft).
- Holding areas for vehicles awaiting passage.
- Suitable road network to support crossing traffic.

5-25. The ERTs use DD Form 3016, *River Reconnaissance Report*, to record the technical information collected. DD Form 3016 is transmitted to the headquarters that ordered the reconnaissance once complete. Some confusion may exist regarding the use of DD Form 3014 and DD Form 3016. DD Form 3014 is used to collect detailed information about an existing, operational ferry while DD Form 3016 is used to collect information when no crossing means (ferry, ford, bridge) exists at collection sites. DD Form 3016 is appropriate when no existing crossing means (ferry, ford, bridge) is present.

5-26. In either case, the ERT will identify and report locations that permit smooth traffic flow and reduce route obstructions as much as possible. When conducting a river reconnaissance, record the river depth, width, approaches, velocities, and natural and man-made obstacles. (See figure 5-5.) The percent of slope is equal to the grade.

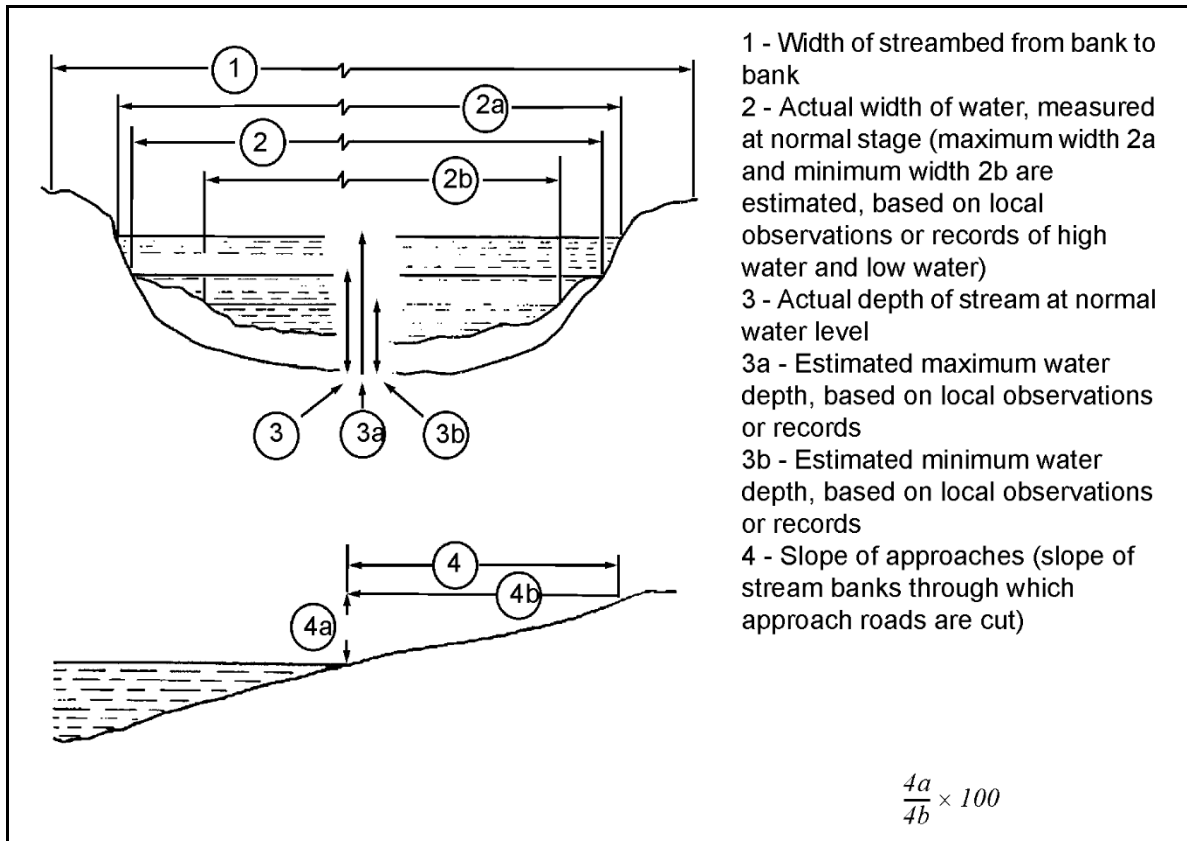

Figure 5-5. Dimensions required for streams and rivers

5-27. Stream depth is usually measured using field-expedient devices (poles, weighted ropes). The depth should be measured every 3 meters along the planned stream-crossing route. Recheck depths and currents frequently during and immediately after any inclement weather. A sudden, heavy rainfall can cause a sluggish stream or river to become torrential quickly, particularly in mountainous, tropical, and arid regions. Monitor weather reports for the areas adjacent to streams and rivers because storms that occur miles away can cause flash flooding. It may also be helpful to review historical meteorological data to determine whether the area is subject to extreme seasonal weather events. Planners should also consider the impact that upstream dams

or locks may have if they become damaged, destroyed, or are opened to regulate (control) local flooding that is caused by inclement weather.

Note. When performing a hasty reconnaissance, the actual depth measured is recorded as the normal depth.

5-28. There are four methods that can be used to determine the width of a gap—

- **Compass method.** This method requires that a compass be used to take an azimuth from a point on the near shore (close to the edge) to a point on the opposite shore (close to the edge). (See figure 5-6.) On the near shore, establish another point that is on a line and at a right angle to the azimuth selected. The azimuth to the same point on the far shore is ± 45 degrees (800 mils) from the previous azimuth. Measure the distance between the two points on the near shore. This distance is equal to the distance across the gap.
- **Aiming circle, azimuth indicator, or alidade method.** Use an aiming circle, azimuth indicator, or alidade to measure the angle between two points that are a known distance apart on the near shore and a third point directly across the gap from one of these points. (See figure 5-7.) Using trigonometric relationships, compute the distance across the gap.
- **Global positioning system method.** Calculate the distance using two known grid points (from a global positioning system).
- **Direct measurement method.** Measure short gaps with a tape measure or a laser range finder

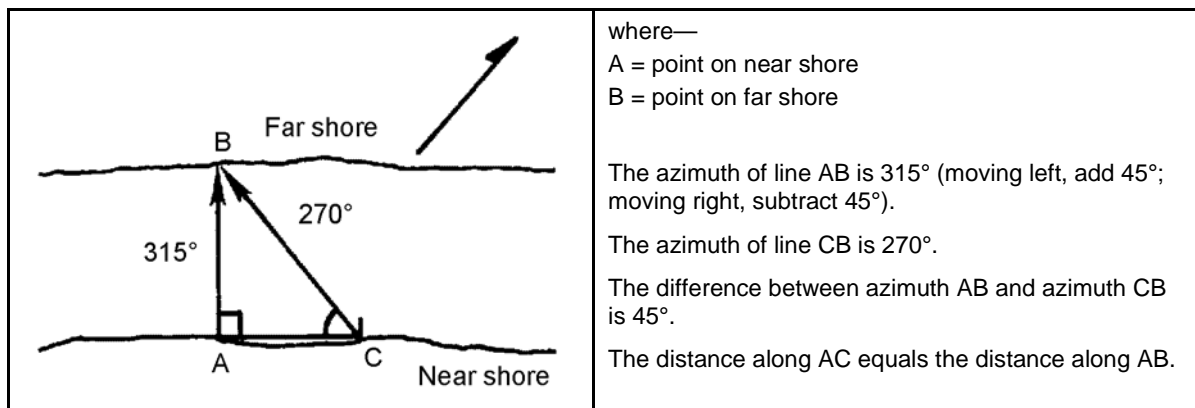

Figure 5-6. Compass method to measure width of stream

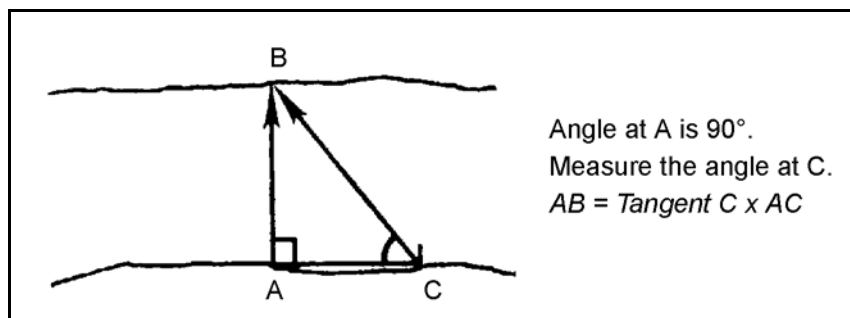

Figure 5-7. Measuring gap width with a surveying instrument

5-29. Current velocities vary in different parts of a stream or river. The velocity is usually slower near the shore and faster in the main channel. Perform the following procedure to determine stream or river velocity—

- Measure a distance along a riverbank.
- Throw a light floating object (not affected by the wind) into the stream or river.
- Record the time it takes the object to travel the measured distance.
- Repeat the procedure at least three times.
- Use the average time of the test in the format shown in figure 5-8 to determine the stream velocity.

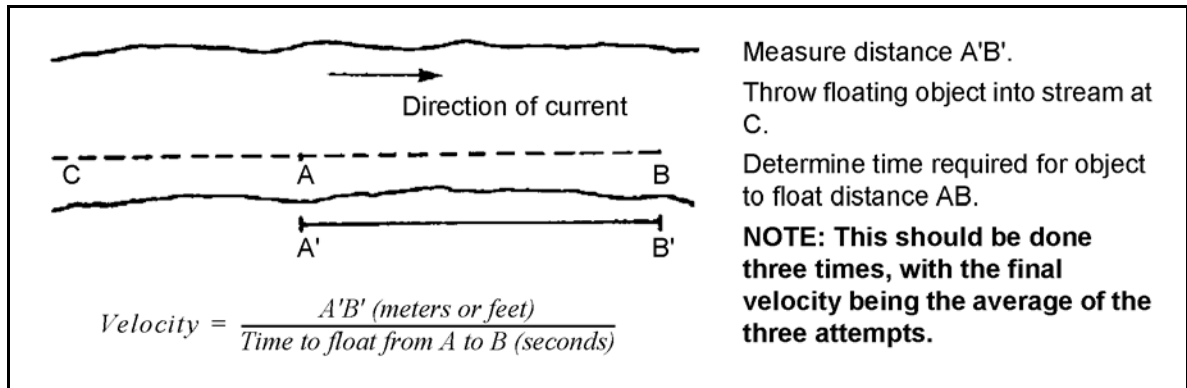

Figure 5-8. Finding stream velocity

5-30. Gently sloping stream approaches are desirable for fording and swimming operations. Slope is expressed in percent. The slope climbing capability is considered for vehicles that are expected to ford or swim the water. This information is usually located on the vehicle data plate, on the vehicle dash plate, or in the vehicle technical manual. When considering slope climbing capability, consider the degrading effects of weather, the condition of the vehicle tires or tracks, the quantity of vehicles using the site, and the condition of the ground surface on both sides of the stream. When bank improvements are necessary, include the scope of work required on DD Form 3015, *Engineer Reconnaissance Report*.

5-31. Consider the following obstacles during river reconnaissance:

- High, vertical banks.
- Mines and booby traps that are located at the entrance, exit, or likely approaches; submerged; or attached to poles and floating logs.
- Debris and floating objects (logs, brush, cadavers, poles, floating logs with wire attached) that can foul propellers and suspension systems.
- Ice crusts.

UNDERWATER RECONNAISSANCE

5-32. The Army engineer force structure includes diving teams that can conduct underwater reconnaissance for deepwater fording sites, and the diving teams determine bottom conditions. When the divers cannot easily span the distance between banks, other means of deployment are required to deliver divers to selected entrances and drop off sites at regular intervals. Engineer light diving teams routinely conduct river reconnaissance at night.

5-33. To assist underwater reconnaissance teams in maintaining direction, weighted lines (transverse lines) may be placed across the bottom of the water obstacle. Buoys or other floating objects are attached to the lines to indicate the survey area for underwater reconnaissance teams. When the current is greater than 1.3 meters per second, underwater reconnaissance personnel will have difficulty maintaining a position along the line selected. To assist divers, another transverse line that is parallel to the original line (with lateral lines connecting both lines) may be placed upstream. The operational techniques that are required to compensate for the current velocity and other environmental factors should be considered when employing a dive team. These can include local security at the reconnaissance site, surface support, and underwater environmental

factors (water temperature, turbidity, visibility, bottom clutter, chemical contamination, biological and other hazards [disease, dangerous marine animals]) that affect the pace and accuracy of the reconnaissance.

ENGINEER RESOURCE ASSESSMENT

5-34. ERTs, augmented ERTs, and assessment teams conduct an engineer resource assessment to determine the location, availability, and suitability of existing engineer resources within an assigned AO, which may be useful or necessary to engineer support. ERTs will typically include an assessment of engineer resources as part of an area reconnaissance, while an assessment team may be nearly exclusively focused on collecting specific engineer resource information.

5-35. The information collected can pertain to availability and suitability of construction materials, raw materials, or local commercial engineer capabilities (skilled labor, equipment, construction firms). The assessment team can be employed in conjunction with other reconnaissance. The assessment team movement must be coordinated with the respective maneuver commander of the area to be reconnoitered by the team. The assessment report is used to report engineer information requirements not adequately covered by any of the other reconnaissance capabilities.

INFRASTRUCTURE RECONNAISSANCE

5-36. **Infrastructure reconnaissance is a multidisciplinary reconnaissance focused on gathering technical information on the condition and capacity of existing public systems, municipal services, and facilities within an assigned area of operations.** Infrastructure reconnaissance seeks to assess SWEAT-MSO. SWEAT-MSO is the common memory aid that reminds users of categories of concern within the infrastructure.

5-37. The engineer will likely be responsible for coordinating infrastructure reconnaissance but also relies on other branches for support depending on the category or required expertise. The infrastructure reconnaissance team includes expertise from at least the engineer, civil affairs, preventive medicine, and military police disciplines. Augmentation from additional disciplines is provided when necessary.

5-38. Similar to other reconnaissance endeavors, infrastructure reconnaissance involves the collection and analysis of data over time. Depending on the intensity and tempo of military activity that is occurring, information collected and reported by the infrastructure assessment and survey teams can overlap as depicted in figure 5-9. As a result, combat engineer units are generally the first to conduct an initial infrastructure assessment. The initial assessment can be used by planners to tailor the composition and guide the positioning of infrastructure survey teams. A series of smartcards are available to assist with the more detailed infrastructure survey. (See appendix C.)

5-39. As the commander becomes concerned about infrastructure issues and how those issues affect the military operation, demand for infrastructure information becomes a priority. Common questions of interest regarding the infrastructure include—

- Has the infrastructure been maintained?
- Who built that component of the infrastructure?
- Are repair parts and equipment available?
- Will host nation employees return to the site after hostilities?
- Is the infrastructure protected or can it be?

5-40. In some infrastructure reconnaissance cases and typically with assessments, the assessment team will be required to collect information on or to inspect infrastructure categories without significant knowledge of the systems being inspected. The results will have significant gaps, but they should be adequate to help prioritize and plan further reconnaissance. Smartcards are employed to focus collection within each infrastructure category on the major technical components of the systems. The smartcards have the following objectives:

- Assist the inspector in identifying and inventorying the primary components of the system.
- Indicate what types of damage the inspector should be looking for and reporting.
- Provide guidance for collecting the information visually or from operators and locals workers.

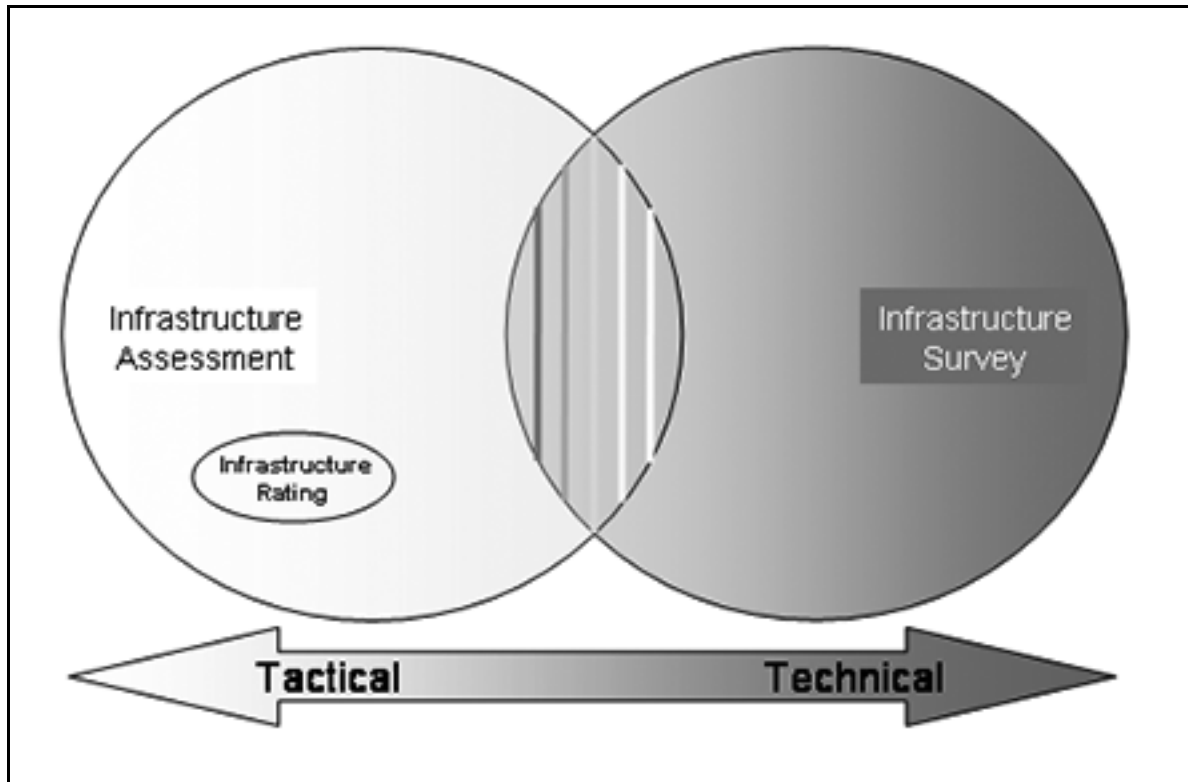

Figure 5-9. Assessment overlapping survey

5-41. Specific situations may not require inspection and inventory of all the components covered in each infrastructure reconnaissance smartcard. The first part of the smartcard provides a brief overview of the infrastructure category, how it works, and some of the major components in the system. The second part is the form that the inspector uses to collect inventory and inspection information. The assessment team should consider relevant SWEAT-MSO work sheet and the following tools to assist in collecting information:

- Multi-tool knife.
- Flashlight.
- Hammer.
- Global positioning system receiver.
- Digital camera.
- Safety equipment (personal protective equipment).
- Tape measure.
- Measuring wheel.
- Binoculars.
- Teleengineering Communications Kit-Deployable.
- Reconnaissance and Surveying Instrument Set (common name: ENFIRE).

5-42. The assessment team may be required to determine an overall status for each infrastructure category. Color-coding is a common status indicator. Table 5-1, page 5-12, provides guidance for the status color-coding of each infrastructure category.

Table 5-1. Status color coding of infrastructure categories

<i>Category</i>	<i>Green</i>	<i>Amber</i>	<i>Red</i>	<i>Black</i>
Sewage	Sewage system works consistently.	Sewage system works, but treatment status is undetermined.	No treatment observed, but treatment plant exists.	Sewage treatment system is destroyed.
	No sewage is observed, and there is no odor.	No sewage is observed, but there is odor present or the system is damaged.	Sewage is observed, and odor is present.	Presence of raw sewage is a public health issue.
	Sewage system is operational in 100% of public facilities.	Sewage system is operational in 50% or more of public facilities.	Operational in less than 50% of public facilities.	No operational sewage in public facilities.
Water	Water distribution works at 100% capacity.	Water distribution works at 50% or more of capacity and/or there are some leaks.	Water distribution does not work.	Water distribution system is destroyed.
	Water tested as clean or local populace is consuming.	Water appears clean, with no smell and the local populace states that it is clean.	Water does not appear clean and local populace states that it is not clean.	Water is tested as nonpotable, appears contaminated, and/or has a bad odor.
	Running water is in 100% of public facilities.	Running water is in 50% or more of public facilities.	Running water is in less than 50% of public facilities.	No running water in public facilities.
Electricity	Power distribution system works; blackouts are planned.	Power distribution system works; blackouts are unplanned.	Power distribution system is unreliable; there are frequent blackouts.	Power distribution system is destroyed.
	Electric lines are 100%; there is no damage and/or no power loss.	Electric lines are 50%; there is minor damage or undetermined power loss.	Electric lines are less than 50%; there is major damage or noticeable power loss.	Electric lines are all down; hot wires exposed; significant power loss.
	Power grid station intact and secure.	Power grid station is operational, but it is not secure.	Power grid station is nonoperational; unable to secure.	Power grid station is stripped or destroyed.
Academics	Building is serviceable; all utilities operational and secure.	Building is adequate; utilities operate over 50%, but are not secure.	Building is useable; utilities operate less than 50%; not secure.	Building is not useable; utilities are nonfunctional.
	Academic resources are available to all students.	Academic resources are available to 50% or more.	Academic resources are available to less than 50%.	Extremely limited academic resources.
Trash	Formal trash collection system is operational.	Formal trash collection system exists, but it is limited.	No formal trash collection system.	No trash collection.
	Trash collection is in a central area that does not present a health hazard.	No known central trash collection area.	Central trash collection area presents a possible health hazard.	Trash is consolidated in an area that presents a health hazard.
	No trash buildup in public facilities.	Limited trash in public facilities; relatively clean.	Public facilities have no means to remove trash.	Public facilities have excess trash.

Table 5-1. Status color coding of infrastructure categories (continued)

Category	Green	Amber	Red	Black
Medical	Medical facilities are functional and secure; there is backup power and minimal equipment issues.	Medical facilities are useable but not secure; there is no backup power and some equipment shortages.	Medical facilities are unsanitary; there are significant equipment and supply shortages.	Medical facilities are not useable due to damage, unsanitary conditions, or looting.
	Emergency services are available, including multiple ambulatory services.	Emergency services exist (ground transport only).	Emergency services are unavailable; ground transport does not have medically trained personnel.	Emergency services are not available.
	Veterinary services are available; an animal holding area is available.	Limited veterinary services are available; holding area is inadequate.	On-call veterinary services, but no holding area.	Veterinary services are not available.
(Public) Safety	Police department is functional; the building is secure; equipment is available and operational.	Police department is functional a minimum of 50%; building is securable; equipment is available and operational more than 50%.	Police department is functional less than 50%; unable to secure the building; limited equipment is available.	Police department is nonfunctional; building is not useable; equipment is unavailable.
	Fire department is functional; building is secure; equipment is available and operational.	Fire department is functional a minimum of 50%; building is securable; equipment is available and operational more than 50%.	Fire department is functional less than 50%; unable to secure the building; limited equipment is available.	Fire department is nonfunctional; building is not useable; equipment is unavailable.
Other considerations: Roads and Railroads	Road is Class C at a minimum that can be upgraded, and it has no visible damage.	Road is Class D at a minimum; damage and upgrade requirements will affect traffic flow.	Road is Class E at a minimum; upgrade requirements are significant, and materials are not readily available.	Road is not trafficable.
	Railroad system is operational.	Railroad is damaged, but resources to repair are available; jacks are available.	Railroad damage is extensive; resources to repair are not readily available.	Railroad system did exist, but it now has extensive damage to the track and the trains.
Other considerations: Bridges and Waterways	Bridges are trafficable, with no visible damage.	Bridges are trafficable; supports are intact, but there is damage to spans.	Bridges are not trafficable for the military and risky for civilians; there is damage to spans and supports.	Bridges are not trafficable, and they are impassable.
	The MLC is verified through ERDC or Naval Facilities Engineering Command.	The MLC is calculated but not verified due to damage.	The MLC is ineffective due to damage.	Construction repair is required before MLC can be determined.

Table 5-1. Status color coding of infrastructure categories (continued)

<i>Category</i>	<i>Green</i>	<i>Amber</i>	<i>Red</i>	<i>Black</i>
Other considerations: Bridges and Waterways (continued)	Inspection and evaluation shows original strength assessment is valid.	Inspection and evaluation determines strength support issues.	Inspection and evaluation determines minimal supportable strength.	Inspection and evaluation determines that the bridge cannot support weight.
Other considerations: Airports	Airport is capable of supporting military and civilian traffic concurrently; there is no visible damage.	Airport can support limited military traffic; there is no visible damage.	Airport is damaged; utilities and structures are not reliable or safe.	Airport is not working or unavailable.
	Runway, taxiway, and parking aprons are serviceable; working and parking maximum aircraft on the ground is greater than or equal to 2 (military).	Runway is serviceable, but taxiway and parking is limited (C130/C17 only).	Runway is not serviceable; but can be repaired with available resources.	Runway is not serviceable; dimensions will not support military aircraft; major repair and upgrades are required.
Other considerations: Housing	Residences are structurally sound and offer protection from the environment.	Residences are damaged and need structural evaluation; they offer limited protection from the environment.	Residences are damaged and structurally unsafe; no protection from the environment.	Residences are destroyed.
	Utilities are working and reliable.	Utilities are working over 50%, but they are not reliable.	Utilities work less than 50% and require significant repairs.	Utilities are nonoperational.
Other considerations: Communications	Telephone system is operational and reliable in public facilities.	Telephone hookups are available; some equipment is available and somewhat reliable.	Limited telephone hookups and equipment are available but not reliable.	Telephone hookups or equipment is not available.
	Postal system is operational and reliable.	Postal system is slow; over 50% of the mail is delivered.	Postal system exists; extremely slow; less than 50% of the mail is delivered.	Postal system is not available.
	Media (television, Internet, radio, newspaper) is operational, available, and reliable.	One form of media exists, is operational, available, and reliable.	One form of media exists, but it has limited availability and reliability.	Media is not available.
Other considerations: Hazardous Materials	Hazardous materials and hazardous waste are properly segregated, stored, and labeled.	Some hazardous materials or hazardous waste is not properly segregated, stored, or labeled.	Hazardous materials or hazardous waste is not properly segregated, stored, or labeled.	Hazardous materials or hazardous waste is not segregated, stored, or labeled.

Table 5-1. Status color coding of infrastructure categories (continued)

Category	Green	Amber	Red	Black
Other considerations: Hazardous Materials (continued)	Containers are adequate for the material.	Containers are not adequate, but there is limited corrosion or damage.	Containers are inadequate, corroded, and leaking.	Containers are inadequate, corroded, and leaking.
	Safety measures and secondary containment is in place.	Safety measures and secondary containment are inadequate.	No safety measures or secondary containment.	Safety measures or secondary containment is not available.
	Hazards communications system is in place.	Hazards communications system is limited.	Hazards communications system is not available.	Hazards communications system is not available.
	No leaks or spills.	Potential for leaks and spills.	Some leaks and spills are present; contaminants may enter air, soil, groundwater, or watercourses.	Gross contamination is present; contaminants have entered air, soil, ground water, and watercourses.
	Spill prevention and cleanup measures is in place and available.	Limited spill prevention and cleanup measures are available.	No ability to prevent or cleanup spills.	No ability to prevent or cleanup spills.
Other considerations: Attitude	Community leaders are not hostile; religious centers are intact; and the community is supportive of general engineering effort.	Community leaders are neutral; religious centers are damaged but securable.	Community leaders are negative; religious centers are damaged and not securable; and community is skeptical of general engineering support.	Community leaders are hostile; religious centers are destroyed; and community does not want general engineering assistance.
	Ethnic tension is not present.	Distinct ethnic groups exist within the AO; they are supportive of general engineering effort if equal among groups.	Distinct ethnic groups exist within the AO; one group is dominant; general engineering tasks cannot be accomplished for all groups.	Ethnic violence occurs; one group is extremely dominant; general engineering effort would increase ethnic tension.
	Unemployment is less than 50%.	Unemployment is greater than 50%; population is willing and able to work to support general engineering effort.	Unemployment is greater than 50%; population is unable to support general engineering work effort.	Unemployment is a serious issue; population is unwilling to support general engineering work effort.
	A formal paramilitary threat is not present.	Paramilitary threat is briefed at the BCT/RCT level.	Paramilitary threat is a concern at the BCT/RCT level.	Paramilitary threat is a concern at the echelons above BCT/RCT level.
<p>Legend: AO area of operations BCT brigade combat team ERDC Engineer Research and Development Center MLC military load classification RCT regimental combat team</p>				

5-43. Infrastructure protection may be another element of the infrastructure reconnaissance process that would commonly be addressed as part of the survey stage. This may be important to maintaining the status quo of the infrastructure evaluated during the survey or in providing security while identified repairs are implemented. Infrastructure protection may also be necessary for a time after the infrastructure elements are in full operation to ensure continuing operation. Considering infrastructure protection in the survey phase requires the identification of threats to the infrastructure elements and the vulnerabilities associated with those threats and the development of courses of action for mitigating those vulnerabilities. Those courses of action could involve hardening components of infrastructure elements, identifying forces to protect them, and identifying redundancies that make protection of individual elements unnecessary.

ENVIRONMENTAL RECONNAISSANCE

5-44. Environmental reconnaissance is focused on collecting technical information on existing environmental conditions and identifying areas that are environmentally sensitive or are of relative environmental concern. An environmental baseline survey is performed before long periods of occupation of a location. Environmental baseline surveys are normally conducted by individuals or teams with a specialized study in geosciences, biology, chemistry or natural sciences, environmental science, environmental policy, or public health. The information collected is used to assess the impact of military operations on the environment and to identify potential environmental impacts on safety and protection. Commanders must be aware of the linkage of environmental concerns to local or regional instabilities. With adequate information on the risks from environmental hazards and the potential for damage to environmentally sensitive areas, planners can mitigate the impact of environmental concerns on the military operation. (See ATP 3-34.5 /MCRP 4-11B for additional information on environmental reconnaissance and surveys.)

AIRFIELD ASSESSMENT

5-45. An airfield assessment is conducted to collect detailed technical information on selected airfields and heliports. Typically, the airfield assessment is preceded by the use of geospatial and other intelligence information. This information provides a baseline level of awareness, helps formulate a listing of preliminary collection requirements, and helps formulate questions about the airfield before arriving at the airfield.

5-46. The assessment is conducted as part of an infrastructure assessment or as a separate mission focused on the selected facility. Based on the situation, the assessment may be conducted by an ERT, an augmented ERT, an assessment team, or a survey team. The level of detail of the information collected increases in the progression from ERT to survey team. The highest level of survey team will often include Air Force technical participation, especially if the airfield is to be used for intertheater or intratheater air mobility. (See FM 5-430-00-1/AFJPAM 32-8013 and FM 5-430-00-2/AFJPAM 32-8013 for additional information on qualities and capabilities of airfields.) In every case, the information collected can be used to determine the airfield operating capacity and to estimate resources for repair or upgrade of the airfield and its supporting facilities. The assessment is recorded using the airfields smartcard tool in the infrastructure reconnaissance smartcard package. (See the [Reachback Engineer Data Integration Smartcard Web site](#) for the smartcard package. See the Web site section of the references for a Web site address.)

5-47. Pavement damage categories are shown in figure 5-10. Damage to the pavement includes the apparent crater damage and the upheaval of pavement around the crater. The damage category for a given munition depends on the delivery method, extent of penetration, and charge size. See UFC 3-270-07 for additional information.

5-48. During the performance of amphibious operations or sustained operations ashore, the MAGTF will conduct a survey of those airfields that are seized to determine their suitability to support aviation missions ashore. When necessary, MAGTF engineer units (and seabees) will be deployed ashore to repair, expand, or improve airfields that have been seized and surveyed. Additional details regarding airfield repair, expansion, improvement, and airfield damage repair techniques can be found in MCWP 3-21.1.

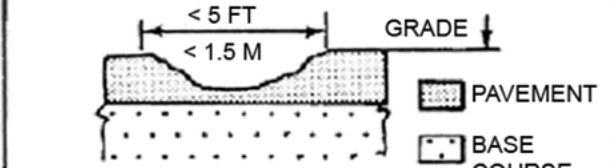
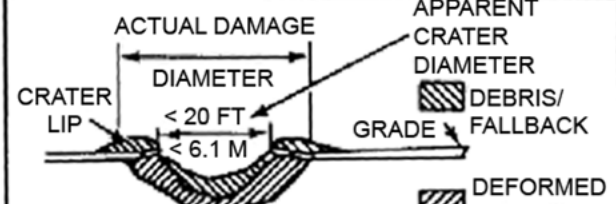
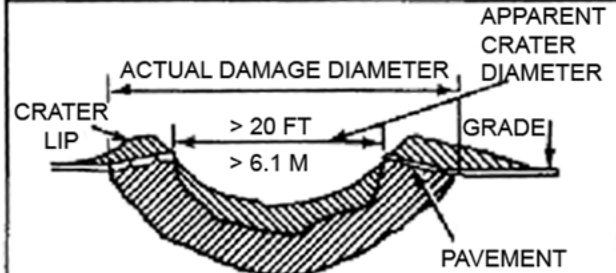
DAMAGE CATEGORY	PROBABLE MUNITIONS	PROBABLE CHARGE SIZE
 <p>A. SPALL/SCAB</p>	<ul style="list-style-type: none"> • SMALL ROCKET • CANNON FIRE • CONTACT-FUSED MUNITIONS 	<p>5-8 LB (2.3-3.6 KG)</p>
 <p>B. SMALL CRATER</p>	<ul style="list-style-type: none"> • LARGE ROCKET • CLUSTERED MUNITIONS • SMALL CONCRETE PENETRATORS 	<p>5-35 LB (2.3-15.8 KG)</p>
 <p>C. LARGE CRATER</p>	<ul style="list-style-type: none"> • BOMBS • DELAY-FUSED MUNITIONS • LARGE CONCRETE PENETRATORS 	<p>> 100 LB (45 KG)</p>

Legend:

ft	foot
kg	kilogram
lb	pound
m	meter

Figure 5-10. Airfield damage categories

5-49. Airfields and heliports are classified by their degree of permanence and type of aircraft (fixed or rotary wing) they are designed to support. These controlling aircraft or aircraft combination are identified for each kind of facility to establish limiting airfield and heliport geometric and surface strength requirements. See ATP 3-37.34/MCWP 3-17.6 for additional information on survivability (hardening) support and the construction of revetments for helicopters.

5-50. The maximum (aircraft) on the ground (MOG) is the maximum number of aircraft that can be accommodated on an airfield. There are two types of MOG:

- Parking MOG is the total number of aircraft that can be parked at an airfield. Parking MOG is affected by the overall size of the airfield and by how available space is managed.
- Working MOG refers to how many or how quickly parked aircraft can be offloaded, material through putted from the aerial port of debarkation, and aircraft serviced and prepared for departure.

5-51. Materials handling equipment, trucks, buses, and other surface transport vehicles, road networks, aircraft support equipment, fuel tankers, personnel, and other factors affect working MOG. Ideally, working MOG equals parking MOG. When it is not equal, backlogs occur. MOG is normally expressed in terms of C-141s. A minimum of MOG Class 2 is desired for airfields. (See AFPAM 10-1403 for aircraft dimensions.)

5-52. Air Force airfields are classified into six mission categories. A controlling aircraft or combination of controlling aircraft has been designated for each category to establish limiting airfield, geometric, and surface strength requirements. These airfield categories include—

- Light (F15, C-17).
- Medium (F-15, C-17, B-52).
- Heavy (F-15, C-5, B-52).
- Modified heavy (F-15, C-17, B-1).
- Auxiliary (F-15).
- Assault landing zone (C-130, C-17).

5-53. On normal operational airfields, pavements are grouped into the following four traffic areas based on their intended use and design load:

- **Type A.** Those traffic areas that receive concentrated traffic and the full design weight of the aircraft. These traffic areas require a greater pavement thickness than other areas on the airfield and include all airfield runways and, in some cases, taxiways. All airfield pavement structures on contingency operations airfields are considered Type A traffic areas.
- **Type B.** Those traffic areas that receive a more even traffic flow and the full design weight of the aircraft. These traffic areas include parking aprons, pads, and hardstands.
- **Type C.** Those traffic areas with a low volume of traffic or the applied weight of the operating aircraft is generally less than the design weight. These traffic areas include secondary taxiways and washrack pavements.
- **Type D.** Those traffic areas with an extremely low volume of traffic or the applied weight of the operating aircraft is considerably lower than the design weight.

5-54. An airfield can also be described based on its location within the AO—

- **Forward airfields.** Forward airfields provide focused logistics support or support combat missions of short-range aircraft (such as attack helicopters and UAS during contingency operations). These airfields are designed to initial or temporary contingency operations standards depending on mission and operational requirements, and forward airfields may be paved or semiprepared. These may be initially prepared or repaired as FACE tasks.
- **Intermediate airfields.** Intermediate airfields Provide general logistics support and support combat missions of longer-range aircraft during contingency operations or training. These airfields are designed to temporary or semipermanent standards depending on mission and operational requirements. Intermediate airfields are normally paved. These airfields provide a link between forward tactical airfields and sustainment level airfields.
- **Airfields.** Airfields provide logistics support forward from fixed, secure bases and support combat operations of long-range aircraft or training. These airfields are designed to be semipermanent or permanent facilities.

5-55. For airfield planning and design, refer to the following publications:

- FM 5-430-00-1/AFJPAM 32-8013.
- FM 5-430-00-2/AFJPAM 32-8013.
- TM 5-820-1/AFM 88-5, Chapter 1.
- UFC 3-260-01.
- UFC 3-260-02.
- UFC 4-141-10N.

Appendix A

Metric Conversion Chart

This appendix complies with AR 25-30 which states that weights, distances, quantities, and measurements contained in Army publications will be expressed in both U.S. standard and metric units. Table A-1 is a metric conversion chart for the measurements used in this publication. For a complete listing of preferred metric units for general use, see Fed-Std-376B.

Table A-1. Metric conversion chart

<i>U.S. Units</i>	<i>Multiplied By</i>	<i>Equals Metric Units</i>
Feet	0.30480	Meters
Feet per second	18.28800	Meters per second
Inches	2.54000	Centimeters
Inches	0.02540	Meters
Inches	25.40010	Millimeters
Miles (statue)	1.60930	Kilometers
Pounds	453.59000	Grams
Pounds	0.45360	Kilograms
Pounds per square inch	6.9000	Kilopascal
Short tons	0.90700	Metric (long) tons
Square feet	0.09290	Square meters
Square inches	6.45160	Square centimeters
Square yards	0.83610	Square meters
Yards	0.91400	Meters
<i>Metric Units</i>	<i>Multiplied By</i>	<i>Equals U.S. Units</i>
Centimeters	0.39370	Inches
Kilograms	2.20460	Pounds
Grams	0.0022046	Pounds
Kilometers	0.62137	Miles (statute)
Kilopascal	0.14493	Pounds per square inch
Meters	3.28080	Feet
Meters	39.37000	Inches
Meters	1.09360	Yards
Meters per second	3.28080	Feet per second
Metric (long) tons	1.10200	Short tons
Millimeters	0.03937	Inches
Square centimeters	0.15500	Square inches
Square meters	1.19600	Square yards
Square meters	10.76400	Square feet
Legend:		
U.S.	United States	

This page intentionally left blank.

Appendix B

Reporting

This appendix is intended to provide a quick reference for reporting of engineer related technical information. The first section provides, in table format, the various symbols used to describe the results of a route classification on an overlay. The second section provides examples of various report formats useful in documenting and reporting the results of technical engineer reconnaissance support. See FM 3-34.210/MCRP 3-17.2D for an explosive hazard survey form and instructions.

ROUTE CLASSIFICATION SYMBOLS

B-1. Table B-1 identifies symbols used on route classification overlays.

Table B-1. Route classification symbols

<i>Symbol</i>	<i>Definition</i>
	<p>Bridge symbol (abbreviated). Use this symbol only when the map scale does not permit the use of the full NATO bridge symbol. Submit DD Form 3011 if this symbol is used. Draw an arrow to the map location of the bridge. Show the bridge serial number in the lower portion of the symbol and the MLC for single-flow traffic in the upper portion. If there are separate load classifications for tracked or wheeled vehicles, show the lesser classification. Underline the classification number if the width or overhead clearance is below minimum requirements.</p>
	<p>Bridge symbol (NATO). The bridge symbol shows—</p> <ul style="list-style-type: none"> • Two-way wheeled classification, on the top left. • One-way wheeled classification, on the top right. • Two-way tracked classification, on the middle left. • One-way tracked classification, on the middle right. • Assigned serial number, bottom inside circle. • Traveled-way width, bottom outside circle. • Overhead clearance, on the outside left. • Length, on the outside right.
	<p>Bridge symbol (railway). Place RL above the symbol to indicate a railway bridge. At the left of the symbol, show the overhead clearance (in meters). Show the bridge overall length (in meters) at the right of the symbol. Indicate the traveled-way width below the symbol and underline it if it is below standard for the classification. Inside the symbol, show the bridge classification in the upper half. If the class is different for single- and double-flow traffic, show single flow on the left and double flow on the right. Place the railway bridge serial number in the lower half of the symbol. Draw an arrow to the map location of the bridge. On the arrow shaft, indicate the ease of adapting the bridge for road-vehicle use. A zigzag line means it would be difficult to adapt; a straight line means it would be easy to adapt. Place the bypass symbol on the arrow shaft to indicate bypass conditions. Show the bridge adapted traveled-way width directly below the symbol. Place the number of hours to adapt the bridge to a vehicular roadway below the railway bridge width number. More than 4 hours to adapt railway to roadway must be circled.</p>
	<p>Bypass symbols shown indicate (from left to right) that the bypass is easy, difficult, or impossible.</p>

Table B-1. Route classification symbols (continued)





Symbol	Definition
	<p>Concealment. Show roads lined with trees by a single line of circles for deciduous trees and a single line of inverted Vs for evergreen trees. Show woods bordering a road by several rows of circles for deciduous trees and several rows of inverted Vs for evergreen trees.</p>
	<p>Critical points. Number (in order) and describe critical points on DD Form 3015. Use critical points to show features not adequately covered by other symbols on the overlay.</p>
	<p>Constriction (underpass). The number on the left shows the narrowest width of the constriction; the number on the right is the overhead clearance (minimum/maximum). Both dimensions are in meters.</p>
	<p>Constriction (width). The number on the left shows the narrowest width of the constriction; the number on the right is the length of the route that is constricted. Both dimensions are in meters.</p>
	<p>Curve with a radius less than 45 meters. The symbol points toward the curve location and shows the actual radius of the curve outside of the triangle.</p> <p>A series of sharp curves is shown with a triangle drawn inside another triangle. The number of curves followed by the radius of the sharpest curve is shown outside of the triangles.</p>
	<p>Ferry symbol. The ferry symbol shows—</p> <ul style="list-style-type: none"> Assigned serial number, on the top left. Ferry type (V, P, or both), on the top right. MLC, enclosed left. Dead-weight capacity (if known), enclosed right. Ferry turnaround time, bottom bank conditions shown by arrow neck and tail.
	<p>Ford symbol. The ford symbol shows—</p> <ul style="list-style-type: none"> Assigned serial number, on the top left. Ford type (V, P or both), the top second from the left. Stream normal velocity, the top second from the right. Route type (X, Y, or Z), on the top right. Length of the ford, on the bottom left. Ford width, on the bottom second from left. Nature of the ford bottom, on the bottom second from the right. Normal depth, on the bottom right.
	<p>Grades—</p> <ul style="list-style-type: none"> Single arrowhead pointing up—indicates a grade between 5 to 6.9%. Double arrowhead pointing up—indicates a grade between 7 to 9.9%. Triple arrowhead pointing up—indicates a grade between 10 to 14.9%. Four arrowheads pointing up—indicates a grade that is 15% and over.

Table B-1. Route classification symbols (continued)

Symbol	Definition																										
	<p>Limits of the reconnoitered route. Show the reconnoitered section starting and ending points of a route covered by reconnaissance with open-ended arrows. Further, designate sections of the route that are included by using alphanumeric designations.</p>																										
	<p>Parking area.</p>																										
<p>4.2</p> 	<p>Railroad grade crossing. Use this symbol to show a level crossing where passing trains would interrupt traffic flow. If there is a power line present, show its height (in meters) from the ground. Underline the overhead clearance if it is less than 4.3 meters.</p>																										
<p>10.5m/X/120/00 6m/Z/30/4.1m/(OB) 9m/V/40/5m/(OB) (W)</p>	<p>Route classification format consists of, from left to right—</p> <ul style="list-style-type: none"> • Route width, in meters. • Route type (X, Y, or Z). • Lowest MLC. • Lowest overhead clearance, in meters. • Obstructions to traffic flow (OB). • Seasonal conditions (T or W). 																										
	<p>Tunnel symbol shows—</p> <ul style="list-style-type: none"> • Minimum/maximum overhead clearance, top left. • Traveled-way width, bottom center. • Tunnel length, top right. • Assigned serial number, inside tunnel type sketch. • Bypass type, on arrow toward tunnel. 																										
<p>4.00</p> 	<p>Turnout. Use this symbol to show the possibility of driving off the road. Draw the arrow in the direction of the turnout (right or left of the road). For wheeled vehicles, draw a small circle on the arrow shaft. For tracked vehicles, draw a small square on the arrow shaft and place the length of the turnout, in meters, at the tip of the arrow. When a turnout is longer than 1 kilometer, use double arrows.</p>																										
<p>Legend:</p> <table> <tr> <td>DD</td> <td>Department of Defense</td> </tr> <tr> <td>m</td> <td>meter</td> </tr> <tr> <td>MLC</td> <td>military load classification</td> </tr> <tr> <td>NATO</td> <td>North Atlantic Treaty Organization</td> </tr> <tr> <td>OB</td> <td>obstructions to traffic flow</td> </tr> <tr> <td>P</td> <td>pedestrian</td> </tr> <tr> <td>RL</td> <td>railway bridge</td> </tr> <tr> <td>T</td> <td>tracked</td> </tr> <tr> <td>V</td> <td>vehicular</td> </tr> <tr> <td>W</td> <td>flooding</td> </tr> <tr> <td>X</td> <td>all weather</td> </tr> <tr> <td>Y</td> <td>limited weather</td> </tr> <tr> <td>Z</td> <td>fair weather</td> </tr> </table>		DD	Department of Defense	m	meter	MLC	military load classification	NATO	North Atlantic Treaty Organization	OB	obstructions to traffic flow	P	pedestrian	RL	railway bridge	T	tracked	V	vehicular	W	flooding	X	all weather	Y	limited weather	Z	fair weather
DD	Department of Defense																										
m	meter																										
MLC	military load classification																										
NATO	North Atlantic Treaty Organization																										
OB	obstructions to traffic flow																										
P	pedestrian																										
RL	railway bridge																										
T	tracked																										
V	vehicular																										
W	flooding																										
X	all weather																										
Y	limited weather																										
Z	fair weather																										

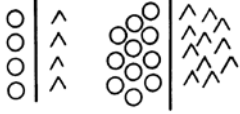
ENGINEER RECONNAISSANCE REPORTS

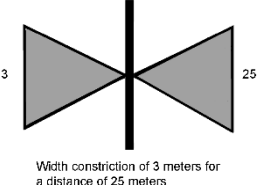
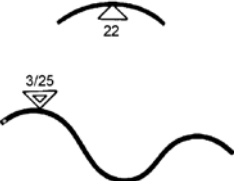
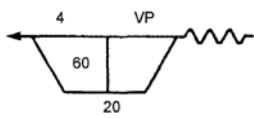
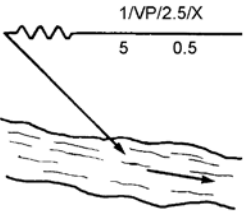
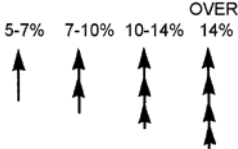
B-2. Table B-2 provides a summary of the various engineer reconnaissance reports and the page reference in this appendix where an example is provided.

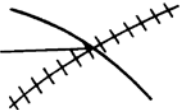
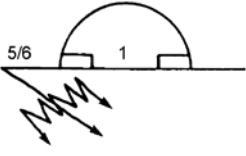
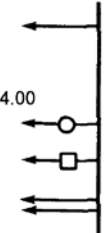
Table B-2. Engineer reconnaissance reports

<i>Form</i>	<i>Page</i>
DD Form 3009, <i>Route Classification</i> (formerly DA Form 1247)	Page B-5
DD Form 3010, <i>Road Reconnaissance Report</i> (formerly DA Form 1248)	Page B-12
DD Form 3011, <i>Bridge Reconnaissance Report</i> (formerly DA Form 1249)	Page B-15
DD Form 3012, <i>Tunnel Reconnaissance Report</i> (formerly DA Form 1250)	Page B-20
DD Form 3013, <i>Ford Reconnaissance Report</i> (formerly DA Form 1251)	Page B-23
DD Form 3014, <i>Ferry Reconnaissance Report</i> (formerly DA Form 1252)	Page B-26
DD Form 3015, <i>Engineer Reconnaissance Report</i> (formerly DA Form 1711)	Page B-29
DD Form 3016, <i>River Reconnaissance Report</i> (formerly DA Form 7398)	Page B-33
Legend:	
DA	Department of the Army
DD	Department of Defense

DD FORM 3009

B-3. Use a DD Form 3009 to report the technical information collected during route classification. Additionally, route classification information is summarized on the route classification overlay as described in chapter 5. Complete the route classification form as shown in figure B-1.

ROUTE CLASSIFICATION									
For use of this form, see ATP 3-34.81/MCWP 3-17.4; the proponent agency is TRADOC.									
SECTION I									
1. SERIAL NUMBER 001					2. TO S-2, 21st Engineer Battalion				
3. FOR INFORMATION fred.smith@us.army.mil					4. DATE/TIME GROUP 1 Nov 15				
5. NUMBER OF SHEETS OR ENCLOSURES 3					6. RECONNAISSANCE OFFICER/NCO Fred Smith, SFC				
7. UNIT A Company, 21st Engineer Battalion					8. FORMATION 1st Brigade Combat Team				
9. SIGNATURE SFC Fred Smith									
10. UNITS USED IN THE FORM (Please check)									
<input type="checkbox"/> CENTIMETERS <input type="checkbox"/> INCHES <input type="checkbox"/> FEET <input type="checkbox"/> MILES <input type="checkbox"/> METERS <input checked="" type="checkbox"/> KILOMETERS <input type="checkbox"/> CENTIGRADE <input type="checkbox"/> FAHRENHEIT									
11. MAPS									
12. COUNTRY USA					13. NAME Fort Belvoir Special				
14. EDITION AMS					15. SHEET NUMBER 5561 IV				
16. SERIAL V763					17. SCALE 1:50,000				
SECTION II									
1. ROUTE CLASSIFICATION (See Section VII, Block 4)							2. LIMITED BY SECTIONS		
6.7 / Y / 80 / 6 () () ()							C		
1 / 2 3 4 5 5 5									
SECTION III									
1. ROAD CLASSIFICATION (See Section VII, Block 7.2)				2. WEATHER (Include last rainfall, if known, plus the temperature)			3. GRID REFERENCE - START		
				Fair; temperature 79 degrees. Last rainfall 15 Oct 15			UT 122864		
4. ROAD									
SECTION A		5. PREFIX	6. LIMITED FACTORS	7. WIDTH	8. CONSTRUCTION	9. LENGTH	10. OBSTRUCTIONS		
11. START GRID	12. FORMULA	B	d	7.3/9.3	kb	5 km	OB		
UT 122864	13. SHOULDERS								
SECTION B									
11. START GRID	12. FORMULA	A		7.0/9.0	kb	5 km	OB		
UT 110910	13. SHOULDERS								
SECTION C									
11. START GRID	12. FORMULA	B	cgd	6.7/8.7	kb	6 km	OB		
UT 119921	13. SHOULDERS								
SECTION D									
11. START GRID	12. FORMULA								
	13. SHOULDERS								
14. GRID REFERENCE - END:									
SECTION IV									
1. ENCLOSURES									
SERIAL	TITLE	ATTACHED	SERIAL	TITLE	ATTACHED				
1	OVERLAY(S)	X	6	RAPID BRIDGE ASSESSMENT(S)					
2	MAP(S)	X	7	DETAILED BRIDGE ASSESSMENT(S)					
3	DETAILED SKETCH(ES)		8	PHOTOGRAPH(S)					
4	CALCULATION(S)		9	OTHER (Describe):					
5	WORK ESTIMATE(S)		10	OTHER (Describe):					

DD FORM 3009, DEC 2015

REPLACES DA FORM 1247, WHICH IS OBSOLETE.

Page 1 of 6 Pages
Adobe Professional X

Figure B-1. Sample DD Form 3009

SECTION V										
1. OBSTRUCTIONS AND RECOMMENDATIONS FOR UPGRADES										
2. SERIAL	3. OBSTRUCTION DETAILS (Including existing MLC)	4. ROAD SECTION	5. GRID	6. RECOMMENDATION FOR UPGRADE (Including new MLC)	7. MANPOWER	8. EQUIPMENT/ VEHICLES	9. CONSTRUCTION MATERIAL	10. TIME	11. NEW MLC	
1	Constriction - 7.3 250 M LONG	A	UT 119872							
2	Constriction - 7 m 20 m long	B	UT 115916							
3	Overpass - 6 m	B	UT 113922							
4	Sharp curve - 21 m	C	UT 112938							
5	Sharp grade - 8 percent	C	UT 109957							

SAMPLE

Figure B-1. Sample DD Form 3009 (continued)

SECTION VI	
<p>1. ROUTE CHART</p>	<p>Section A</p> <p>Section B</p> <p>Section C</p>
	<p>a. NAME SFC Fred Smith</p> <p>b. UNIT A Company, 21st Engineer Battalion</p> <p>c. DATE/TIME GROUP 011430ZJUL15</p> <p>d. SCALE NA</p> <p>e. REMARKS None.</p>
<p>2. NOTES</p> <p>None.</p>	

DD FORM 3009, DEC 2015

Page 3 of 6 Pages

Figure B-1. Sample DD Form 3009 (continued)

SECTION VII			
7.1. FACTORS USED IN ROUTE CLASSIFICATION FORMULAS. For example, 3.5/X/70/3.9(OB)			
SERIAL	FACTOR	SYMBOL	MEANING
1	WIDTH	For example, 3.5 meters	The width of the narrowest part for any given section.
2	ROUTE TYPE	X	All-weather route - waterproof surface, never closed by weather other than snow or flooding.
		Y	Limited all-weather route - loose or light surface, sometimes reduced volume of traffic due to bad weather.
		Z	Fair weather route - quickly impassable in adverse weather.
3	MLC	For example, 70	The maximum MLC of the vehicle which can use the route in convoy.
4	OVERHEAD CLEARANCE	For example, 3.9	The minimum vertical distance between the route or road surface and any overhead obstruction. Only included if height is less than the required for the MLC.
5	OBSTRUCTION TO TRAFFIC OTHER THAN A BRIDGE	(OB)	Temporary or single obstructions.
		(T)	Regular, recurrent and serious snow blockage.
		(W)	Regular, recurrent, and serious flooding.
7.2. FACTORS USED IN ROAD CLASSIFICATION FORMULAS.			
SERIAL	FACTOR	SYMBOL	MEANING
1	PREFIX	A	No limiting factors.
		B	One or more limiting factors.
2	LIMITING FACTORS:		
	SHARP CURVES	c	Radius less than 25 meters and deflecting the direction more than 90. ^o
	STEEP GRADIENTS	g	Gradients of 7 percent or over.
	POOR DRAINAGE	d	Inadequate or blocked drainage.
	WEAK FOUNDATIONS	f	Unstable, loose, or easily displaced.
	ROUGH SURFACE	s	Likely to reduce convoy speed.
	EXCESSIVE CAMBER OR SUPER ELEVATION	j	Likely to cause heavy vehicle to skid or drag towards roadside.
DOUBTFUL CONDITIONS	?	Indeterminate or doubtful conditions expressed with ? and (). For example, (f?).	
	SHOULDERS	-	No symbol, but written reports should specify.
3	WIDTH	/	Width of travelled way or total width including shoulders (when they are usable).
	CONSTRUCTION MATERIAL:		
	TYPE X ROUTE	k kb	Concrete. Bituminous or asphaltic concrete.
	TYPE X OR Y ROUTE	p rb	Paving brick or stone. Bitumen penetrated macadam, water-bound macadam with superficial asphalt or tar cover.
4	TYPE Y ROUTE	r l	Water-bound macadam, crushed rock or coral. Gravel or lightly metaled.
	TYPE Y OR Z ROUTE	nb	Bituminous surface treatment on natural earth, stabilized soil, sand-clay, and so forth.
	TYPE Z ROUTE	n b v	Natural earth, stabilized soil, sand-clay, shell, cinders, and so forth. Bituminous construction. To be used alone only when type of bituminous construction cannot be determined. Various other types not mentioned above.
5	LENGTH	(km)	The length of the section in kilometers may be added in brackets if desired.
6	OBSTRUCTIONS: SNOW FLOODING	(OB)	Symbol at the end of the formula indicates existence of obstruction.
		(T)	Regular, recurrent and serious snow blockage.
		(W)	Regular and sufficiently flooding which impedes traffic flow.

Figure B-1. Sample DD Form 3009 (continued)

7.2. FACTORS USED IN ROAD CLASSIFICATION FORMULAS. (continued)

NOTE. Consider the following as obstructions:

- Overhead clearance less than 4.3 meters.
- Reductions in road widths which limit traffic capacity, such as craters.
- Gradients of 7 percent and over.
- Curves with less than a 25-meter radius and deflecting more than 90.^o
- Ford and ferries.

Example: $B/c(f?)3.2/4.8/p/(4.5km)(OB)(T)$

According to the width, classify a route or road as follows:

- **Limited access.** Up to 3.5 meters wide; it permits passage of isolated vehicles in one direction only.
- **Single lane.** From 3.5 to 5.5 meters wide; it permits use only in one direction at any one time.
- **Single flow.** From 5.5 to 7.5 meters wide; it permits isolated vehicles to pass or travel in the opposite direction to the main flow.
- **Double flow.** Over 7.3 meters wide; it permits two columns of vehicles to proceed simultaneously.

7.3. MEASURING THE RADIUS OF AN EXISTING CURVE

Step 1. A chord AB is set out as shown and bisected at C, so that AC = BC = a.

Step 2. From point C, the perpendicular offset (x) is measured at point D of the curve.

Step 3. The radius is calculated from the formula. $R = \frac{x^2 + a^2}{2x}$

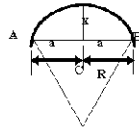

7.4. CONVERSION FACTORS.

U.S. UNITS	MULTIPLIED BY	EQUALS METRIC UNITS
CENTIMETER	0.39370	INCH
FOOT	0.30480	METER
INCH	2.54000	CENTIMETER
KILOMETER	0.62137	MILE
METER	3.28084	FEET
MILE	1.60934	KILOMETER

TEMPERATURE		
CENTIGRADE DEGREES	$C^{\circ} = \frac{5(F^{\circ} - 32)}{9}$	FAHRENHEIT DEGREES
FAHRENHEIT DEGREES	$F^{\circ} = \frac{9C^{\circ}}{5} + 32$	CENTIGRADE DEGREES

DD FORM 3009, DEC 2015 Page 5 of 6 Pages

Figure B-1. Sample DD Form 3009 (continued)

7.5. SYMBOLS AND DESCRIPTIONS	
SYMBOLS	DESCRIPTION
	<p><u>Sharp curve.</u> Less than 25 meters (the figure indicates radius) [left] <u>Series of sharp curves.</u> The figures indicate the number of curves/radius [right]</p>
	<p><u>Steep grade.</u> Arrows point up hill; grade in percent (length of the arrows may show the length of the grade when the scale allows)</p>
	<p><u>Constriction.</u> Left-Width Right-Total length</p>
	<p><u>Arch constriction.</u> Left-Width Right-Overhead clearance</p>
	<p><u>Tunnel.</u> Left-Height Right-Length Bottom-Roadway and total width (include footpath)</p>
	<p><u>Underpass constriction.</u> Width [left] and height [right]</p>
	<p><u>Obstacle bypass.</u> Easy-Can be crossed within the immediate vicinity by a NATO truck equivalent to a 2.5-ton truck. Difficult-Can be crossed within the immediate vicinity, but some work will be necessary to prepare the bypass. Impossible-Can be crossed after repairing/building of a new construction, or by a detour.</p>
	<p><u>Level crossing.</u> The figure indicates the height of the power line above ground.</p>
	<p><u>Bridge.</u> Arrow to the location Top segment-MLC Left-Overhead clearance In the middle-Serial number</p> <p><u>Culvert.</u> Arrow to location. Top-Depth of fill Bottom-Diameter of pipe]</p>
	<p><u>Limits of sector.</u> Left <u>Critical point.</u> Right-to be numbered and described in a remark frame).</p>
	<p><u>Concealment.</u> Line of trees (deciduous) Left-Evergreen Right-Woods</p> <p><u>Possibility of driving off the road.</u> Denoted by an arrow. For wheeled vehicles, the figure indicates the length of road where driving off is possible [left] or for tracked vehicles [right]).</p>
	<p><u>Ferry.</u> Arrow to the location Top-serial number and type (V = vehicle, P = pedestrian) Bottom-MLC</p>
	<p><u>Ford.</u> Arrow to the location. Top-serial number, type, current velocity of stream, seasonal limitations (V = vehicle, P = pedestrian, X = without seasonal limitations, Y = seasonal limitations). Bottom-length of crossing, width of ford, nature of bottom, depth (M = mud, C = clay, S = sand, G = gravel, R = rock, P = artificial paving).</p>
	<p><u>Difficult approach to cross-site.</u> Symbol omitted for easy.</p>

Figure B-1. Sample DD Form 3009 (continued)

Legend:	
ATP	Army techniques publication
attn	attention
DA	Department of the Army
DD	Department of Defense
Dec	December
Jul	July
km	kilometer
m	meter
MCWP	Marine Corps warfighting publication
MLC	military load class
SFC	Sergeant First Class
TRADOC	United States Army Training and Doctrine Command
USA	United States of America

Figure B-1. Sample DD Form 3009 (continued)

DD FORM 3010

B-4. Use DD Form 3010 to report the technical information collected during road reconnaissance. Additionally, the road information is summarized on the route classification overlay. Complete the road reconnaissance form as follows (see figure B-2, page B-12):

- There are four date blocks on the form (3 on the front side and 1 on the back); record the same date in each.
- Block 1a should indicate the country and the map name, not just the country.
- Block 1c should indicate the sheet number, edition, and map sheet date.
- Block 3 requires at least a 6-digit grid coordinate.
- In section II, record the information for the most limiting characteristics of the road.
- Section III(d) should read, "Curves with a radius of 25 meters or less. Also record curves with a radius of 25.1 to 45 meters."
- In section IV, complete the scale block as follows: Scale: ___units = ___kilometers. Include the road classification format for each section of the road. Indicate obstruction locations on the sketch.

ROAD RECONNAISSANCE REPORT			DATE (YYYYMMDD)	
For use of this form, see ATP 3-34.81/MCWP 3-17.4; proponent agency is TRADOC.			1 July 15	
TO (Headquarters ordering reconnaissance) Commander, ATTN: S-2, 21st Engineer Battalion		FROM (Name, grade and unit of officer or NCO making reconnaissance) Doe, John, 1LT, Company A, 522nd Engineer		
1. MAPS	a. COUNTRY USA, Fort Leonard Wood Special	b. SCALE 1:50,000	c. SHEET NUMBER OF MAPS AMS V733	2. DATE/TIME GROUP (Of signature) 011430ZJUL15
SECTION I - GENERAL ROAD INFORMATION				
3. ROAD GRID REFERENCE		4. ROAD MARKING (Civilian or Military number of road)		5. LENGTH OF ROAD (Miles or kilometers, specify)
a. FROM UT 122864	b. TO UT 097999	Missouri Route J		16 km
6. WIDTH OF ROADWAY (Feet or meters, specify) 6.7 m to 9.3 m		8. WEATHER DURING RECONNAISSANCE (Include last rainfall, if known) Fair - temperature 79 degrees Last rainfall - 15 Jun 15		
7. RECONNAISSANCE				
a. DATE (YYYYMMDD) 1 Jul 15	b. TIME 0615			
SECTION II - DETAILED ROAD INFORMATION				
When circumstances permit more detailed information will be shown in an overlay or on the mileage chart on the reverse side of this form. Use standard symbols.				
9. ALIGNMENT (Check one ONLY)		10. DRAINAGE (Check one ONLY)		
<input type="checkbox"/> (1) FLAT GRADIENTS AND EASY CURVES <input type="checkbox"/> (2) STEEP GRADIENTS (Excess of 7 in 100) <input type="checkbox"/> (3) SHARP CURVES (Radius less than 100 ft (30m)) <input checked="" type="checkbox"/> (4) STEEP GRADIENTS AND SHARP CURVES		<input type="checkbox"/> (1) ADEQUATE DITCHES, CROWN/CAMBER WITH ADEQUATE CULVERTS IN GOOD CONDITION <input checked="" type="checkbox"/> (2) INADEQUATE DITCHES, CROWN/CAMBER OR CULVERTS, ITS CULVERTS OR DITCHES ARE BLOCKED OR OTHER-WISE IN POOR CONDITION		
11. FOUNDATION (Check one ONLY)				
<input checked="" type="checkbox"/> (1) STABILIZED COMPACT MATERIAL OF GOOD QUALITY <input type="checkbox"/> (2) UNSTABLE, LOOSE OR EASILY DISPLACED MATERIAL				
12. SURFACE DESCRIPTION (Complete items 12a and b)				
a. THE SURFACE IS (Check one ONLY)				
<input checked="" type="checkbox"/> (1) FREE OF POTHoles, BUMPS, OR RUTS LIKELY TO REDUCE CONVOY SPEED <input type="checkbox"/> (2) BUMPY, RUTTED OR POTHOLED TO AN EXTENT LIKELY TO REDUCE CONVOY SPEED				
b. TYPE OF SURFACE (Check one ONLY)				
<input type="checkbox"/> (1) CONCRETE <input type="checkbox"/> (6) WATERBOUND MACADAM <input checked="" type="checkbox"/> (2) BITUMINOUS (Specify type where known): Asphalt <input type="checkbox"/> (7) GRAVEL <input type="checkbox"/> (3) BRICK (Pave) <input type="checkbox"/> (8) LIGHTLY METALLED <input type="checkbox"/> (4) STONE (Pave) <input type="checkbox"/> (9) NATURAL OR STABILIZED SOIL, SAND CLAY, SHELL, CINDERS, DISINTEGRATED GRANITE, OR OTHER SELECTED MATERIAL <input type="checkbox"/> (5) CRUSHED ROCK OR CORAL <input type="checkbox"/> (10) OTHER (Describe):				
SECTION III - OBSTRUCTIONS				
List in the columns below particulars of the following obstructions which affect the traffic capacity of a road. If information of any factor cannot be ascertained, insert "NOT KNOWN".				
(a) Overhead obstructions, less than 14 feet or 4.25 meters, such as tunnels, bridges, overhead wires and overhanging buildings.				
(b) Reductions in road widths which limit the traffic capacity, such as craters, narrow bridges, archways, and buildings.				
(c) Excessive gradients (Above 7 in 100)				
(d) Curves less than 100 feet (30 meters) in radius				
(e) Fords				
13.a. SERIAL NUMBER	b. PARTICULARS	c. GRID REFERENCE	d. REMARKS	
1	Sharp grade - 8%	UT 119872	200 m long	
2	Sharp curve	UT 112877	Radius 21 m	
3	Constriction	UT 112878	6.7 m wide, 300 m long	
4	Constriction	UT 105896	7 m wide, 100 m long	
5	Built-up area	UT 094856	7.3 m wide, 2,000 m long	

DD FORM 3010, DEC 2015

REPLACES DA FORM 1248, WHICH IS OBSOLETE.

Adobe Professional X

Figure B-2. Sample DD Form 3010

SECTION IV - MILEAGE CHART			
14. ROUTE		15. SCALE	16. DATE (YYYYMMDD)
a. FROM	b. TO	2 units = 1 km	1 Jul 15
UT 122864	UT 097999		
ROAD INFORMATION	DISTANCE	ROAD INFORMATION	
MILES		10	KILOMETERS
Missouri Route J			
	9		B d 7.3/9.3 kb (5 km) (OB)
(OB) Built-up area 5 (Westfeld)	8	7	
	6		11 km
	4		A 7.0/9.0 kb (5 km) (OB)
(OB) Constriction 4	3		6 km
	2		B cg (f?) 6.7/8.7 kb (6 km) (OB)
(OB) Constriction 3	1		
(OB) Sharp curve 2	0		
(OB) Steep grade 1			
17. REMARKS			
Shoulders are very soft, not stable.			
DD FORM 3010 (BACK), DEC 2015			

Figure B-2. Sample DD Form 3010 (continued)

Legend:	
1LT	First Lieutenant
ATP	Army techniques publication
attn	attention
DA	Department of the Army
DD	Department of Defense
Dec	December
Jul	July
Jun	June
km	kilometer
m	meter
MCWP	Marine Corps warfighting publication
TRADOC	United States Army Training and Doctrine Command
USA	United States of America

Figure B-2. Sample DD Form 3010 (continued)

DD FORM 3011

B-5. Use DD Form 3011 to report the technical information collected during a bridge reconnaissance. The bridge information is summarized on the route classification overlay when part of a route classification. Complete the bridge reconnaissance form as follows (see figure B-3):

- **Column 1.** Record the assigned serial number. This number matches the serial number used in the bridge symbol of the route classification overlay.
- **Column 2.** Record the 8-digit grid coordinates and the map identifier of the bridge site.
- **Column 3.** Record the horizontal clearance information in meters. The horizontal clearance is the clear distance between the inside edges of the bridge structure, measured at a height of 0.3 meters above the surface of the traveled way and upwards. However, horizontal clearance for truss bridges is measured 1.21 meters above the traveled way. Any horizontal clearance less than the minimum required for the bridge roadway width (table B-3, page B-17) is underlined. Unlimited clearance is indicated by the infinity (∞) symbol.
- **Column 4.** Record the under-bridge clearance in meters. It is the clear distance between the underside of each span and the surface of the water. The height above the streambed and the height above the estimated normal water level (pertaining to the appropriate bridge type) are included in this column for each span.
- **Column 5.** If the bridge is oriented more north to south, start with the northern most span and work south. Place the letter N in column 5 before the first span in the sequence. If the bridge is oriented more east than west, start with the eastern most span and work west. Place the letter E in column 5 before the first span in the sequence. For each span, list a sequence number followed by a slash and the total number of spans. Columns 5, 6, 7, and 8 are completed for each span.
- **Column 6.** Record the type of span construction. Refer to the numbers in table B-4, page B-17, and the diagrams in figure B-4, page B-18, for this information.
- **Column 7.** Record the type of construction material. Refer to table B-5, page B-19, for this information.
- **Column 8.** Record the span length in meters. This is a center-to-center spacing between bearings. The sum of the span length may not equal the overall length. Spans that are not usable because of damage or destruction are indicated by the pound (#) symbol, placed after the dimension of the span length. Spans that are over water are indicated by placing the letter W after the dimension of the span length. (See figure B-3.)

BRIDGE RECONNAISSANCE REPORT		DATE (YYYYMMDD)	SIGNATURE						
TO (Headquarters ordering reconnaissance) Commander, ATTN: S-2, 21st Engineer Battalion		1 Jul 15	SFC Gerald Smith						
FROM (Name, grade and unit of officer or NCO conducting Reconnaissance) Gerald Smith, SFC, Company A, 21st Engineer Battalion									
1. MAPS (Country, scale and sheet number or name) USA, 1:50,000, AMS V7333 5561 IV, Quantico									
2. DATETIME GROUP (Of signature) 011430ZJUL15									
3. ESSENTIAL BRIDGE INFORMATION									
a. SERIAL NUMBER	b. LOCATION	c. CLEARANCE		d. SPANS		(4) LENGTH AND CONDITION	16	37.8 m	Easy, ford safe located next to bridge
		(1) HORIZONTAL	(2) UNDER BRIDGE	(1) NUMBER	(2) TYPE OF CONSTRUCTION				
21	L.A. 07216874		9	N 1/6	3	h			
				2/6	3	h			
				3/6	3	h			
				4/6	3	h			
				5/6	3	h			
				6/6	3	h			
4. ADDITIONAL BRIDGE INFORMATION									
(Military log, class, overall length, roadway width, vertical clearance, bridge by-pass) (Add columns as needed)									

Adobe Professional X

REPLACES DA FORM 1249, WHICH IS OBSOLETE

DD FORM 3011, DEC 2015

Figure B-3. Sample DD Form 3011

5. SKETCHES	
a. SIDE ELEVATION	SCALE 1 SQUARE = None
b. CROSS SECTION OF CRITICAL SPAN	SCALE 1 SQUARE = None
<p>Stringer 10" x 16" → CAP (10" x 16") 25.4cm x 40.6cm</p> <p>Wooden Piles 16" dia (40.6 cm)</p> <p>←→ O.C. 44" (61 cm)</p>	<p>d. SITE PLAN</p> <p>SCALE 1 SQUARE = None</p>
c. CROSS SECTION OF CRITICAL MEMBER	SCALE 1 SQUARE = None
<p>←→ 10" (25.4 cm)</p> <p>↑ 16" (40.6 cm)</p>	
6. BRIDGE CLASS COMPUTATION	
None	
DD FORM 3011 (BACK), DEC 2015	

Figure B-3. Sample DD Form 3011 (continued)

Legend:	
ATP	Army techniques publication
attn	attention
cm	centimeter
DA	Department of the Army
DD	Department of Defense
Dec	December
Jul	July
m	meter
MCWP	Marine Corps warfighting publication
Rt	route
SFC	Sergeant First Class
TRADOC	United States Army Training and Doctrine Command
USA	United States of America

Figure B-3. Sample DD Form 3011 (continued)

Table B-3. Minimum roadway widths

Roadway Width (meters)	Bridge Classification	
	One-Way	Two-Way
2.75–3.34	12	0
3.35–3.99	30	0
4–4.49	60	0
4.5–4.99	100	0
5–5.4	150	0
5.5–7.2	150	30
7.3–8.1	150	60
8.2–9.7	150	100
Over 9.8	150	150

Note. The minimum overhead clearance for all classes is 4.3 meters.

Table B-4. Span construction types

Span Type	Number
Truss	1
Girder (including steel multigirder and two girder spans)	2
Beam (including reinforced or prestressed concrete and steel box beam spans)	3
Slab	4
Arch (closed spandrel)	5
Arch (open spandrel)	6
Suspension	7
Floating	8
Swing	9 (specify type in additional information)
Bascule	10 (specify type in additional information)
Vertical lift	11
Other	12 (specify type in additional information)

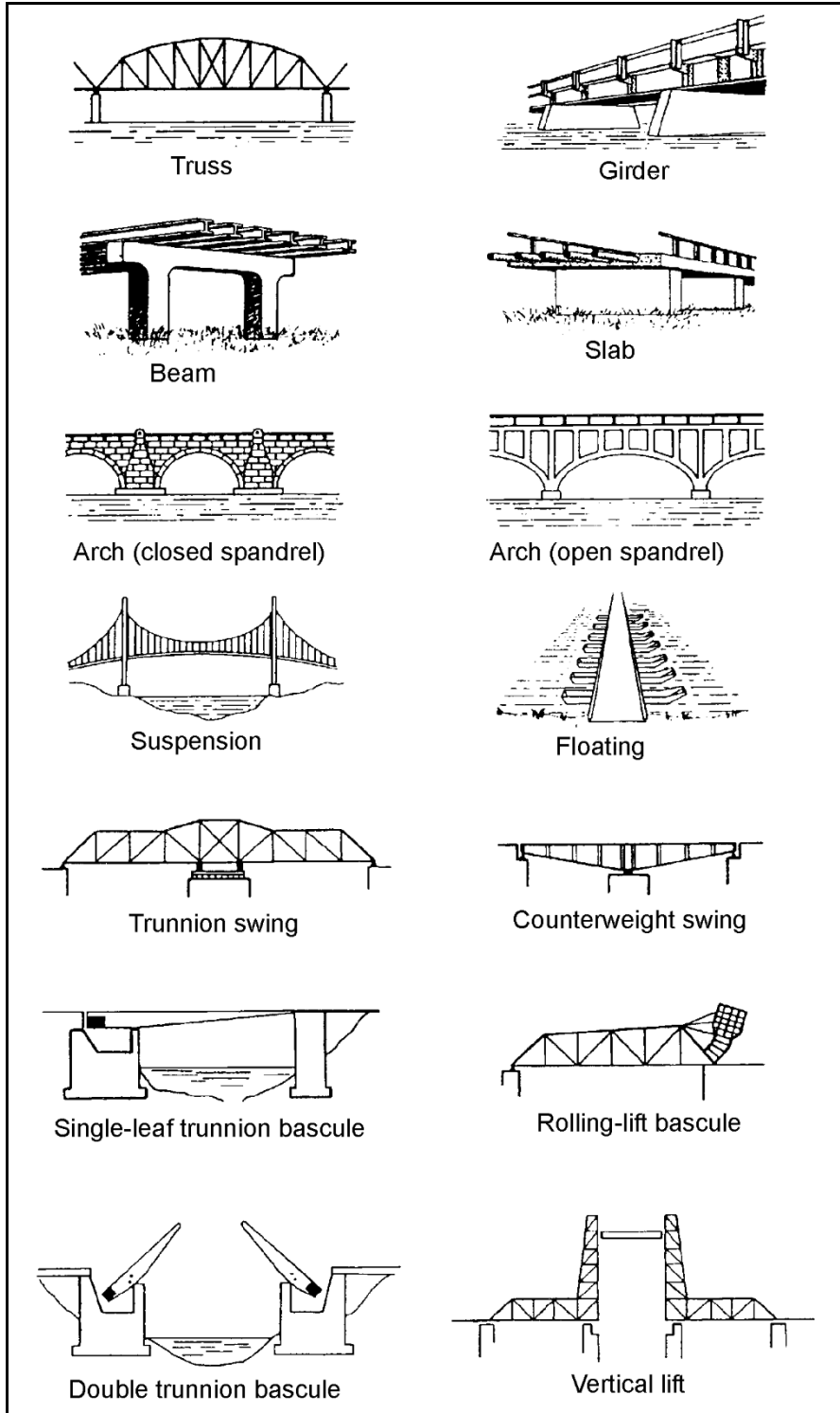

Figure B-4. Typical bridge spans

Table B-5. Construction material

<i>Material of Span Construction</i>	<i>Letter Symbol</i>
Steel or other metal	a
Concrete	k
Reinforced concrete	ak
Prestressed concrete	kk
Stone or brick	p
Wood	h
Other (specify by name)	o

B-6. Under the *Additional Bridge Information* block in DD Form 3011, the columns are added to give the MLC, overall length, roadway width, overhead clearance, and bypass possibilities (specify use easy, difficult, or impossible). Indicate whether the bridge is simply supported or continuous. (See figure B-3, page B-15.)

B-7. DD Form 3011 should include a sketch and photographs when possible. Show as much information as possible when sketching the bridge on page 2 of DD Form 3011 (see figure B-3). For bridges that present a challenge to reconnaissance elements collecting information and determining a classification, reachback assistance is available through the U.S. Army Corps of Engineers and the Naval Facilities Engineering Command.

DD FORM 3012

B-8. Use DD Form 3012 to report the technical information collected during the reconnaissance of tunnels on routes. Additionally, the tunnel information is summarized on the route classification overlay. Complete the tunnel reconnaissance form as follows (see figure B-5, page B-20):

- **Block 2.** Record the grid coordinates for the start of the route on which the tunnel is located.
- **Block 3.** Record the grid coordinates for the end of the route on which the tunnel is located.
- **Block 8.** Record the tunnel number found on the map sheet, head wall, or data plate of the tunnel. If a number is not found, assign an appropriate number based on the unit SOP. If there is a different number on the map than on the tunnel, record both serial numbers.
- **Block 9.** Record the distance and direction from the nearest town.
- **Block 13.** Record the number of railroad tracks passing through the tunnel, if applicable.
- **Block 15.** Record the vertical clearance (the shortest clearance from the road surface in the tunnel to the lowest point on the ceiling above the traveled way). Also, record the distance from the sidewalk to the ceiling if traffic can travel on the sidewalks.
- **Block 15 (continued).** Record the horizontal clearance. The horizontal clearance is the roadway width or the roadway width and sidewalks/emergency lanes (where vehicles can move through the tunnel without striking the top or sides).
- **Block 16.** Record the internal tunnel grade.
- **Block 17.** State whether the tunnel is straight or curved. Record curves that may restrict traffic flow.
- **Block 19.** Record a description of the tunnel entrances (portals) and their composition.
- **Block 22.** Mark the applicable box. Some tunnels are chambered for demolition. This means that the tunnel has predesigned locations for placing demolitions to destroy the tunnel and deny use by the enemy.
- **Block 23.** Record the date that the tunnel was constructed.
- **Block 27.** Record the grade of the tunnel entrances.
- **Block 29.** Inspect the rock or soil at the tunnel entrances. If a rock or mudslide is possible, record the location and possible solution to the problem.

TUNNEL RECONNAISSANCE REPORT				DATE (YYYYMMDD)	
For use of this form, see ATP 3-34.81/MCWP 3-17.4, proponent agency is TRADOC.				2015-07-01	
TO: <i>(Headquarters ordering reconnaissance)</i> Commander, ATTN: S-2, 21st Engineer Battalion			FROM: <i>(Name, grade and unit of reconnaissance officer)</i> Fred Smith, SFC, Company C, 21st Engineer Battalion		
1. ROUTE OR LINE		2. FROM <i>(Initial point)</i>	3. TO <i>(Terminal point)</i>	4. DATE/TIME <i>(Of signature)</i>	
a. HIGHWAY PA 126	b. RAILROAD NA	QQ 366311	QQ 508367	011430ZJUL15	
5. MAP SERIES	6. SHEET NUMBER	7. GRID REFERENCE		8. TUNNEL NUMBER	
PP01	PA 872	a. TYPE 1:25,000	b. COORDINATES QQ 381330	T1	
9. LOCATION FROM NEAREST TOWN				10. TYPE <i>(Subaqueous, rock, soil)</i>	
a. DISTANCE 2.5 kilometers	b. DIRECTION Northeast	c. NAME OF NEAREST TOWN Breezewood, PA		Rock	
11. NAME <i>(Mountain or water feature)</i>		12. LENGTH	13. NUMBER OF TRACKS	14. ROADWAY WIDTH	
Ray's Hill		1,077 meters	0	7 meters	
15. CLEARANCE		16. GRADE <i>(Percent)</i>	17. ALIGNMENT <i>(Straight or radius of curve)</i>		
a. VERTICAL 5 meters	b. HORIZONTAL 7.5 meters	1	Straight		
18. LINING <i>(Material)</i>	19. PORTALS <i>(Material)</i>	20. VENTILATION <i>(Type)</i>			
Concrete	Concrete	Air shaft above tunnels; exhaust fan on western portal. Fan is inoperative.			
21. DRAINAGE Storm drains every 25 meters; 75 centimeters piping.					
22. CHAMBERED FOR DEMOLITION		23. COMPLETED <i>(Year)</i>	24. CONDITION <i>(Check appropriate box)</i>		
<input type="checkbox"/> YES <input checked="" type="checkbox"/> NO		1940	<input type="checkbox"/> EXCELLENT <input type="checkbox"/> GOOD <input checked="" type="checkbox"/> FAIR <input type="checkbox"/> POOR		
25. BYPASSABILITY Impossible on both sides.					
26. ALTERNATE CROSSING From Breezewood, travel east on I-76 to Sidling Hill Plaza.					
27. APPROACHES Western approach to portal 1% up slope and four lane highway in fair condition. Eastern exit from portal 4% down slope and four lane highway in fair condition.					
28. IN-TUNNEL RESTRICTIONS None.					
29. GEOLOGIC DATA Surrounding area near portals stable on both ends.					

DD FORM 3012, DEC 2015

REPLACES DA FORM 1250, WHICH IS OBSOLETE.

Adobe Designer 9.0

Figure B-5. Sample DD Form 3012

30. PLAN AND PROFILE	PLAN SCALE 1 SQUARE =	PROFILE SCALE 1 SQUARE =	HORIZONTAL <input checked="" type="checkbox"/> VERTICAL <input type="checkbox"/>
31. PORTAL VIEW SCALE 1 SQUARE = 0.50	32. CROSS SECTION OF BORE SCALE 1 SQUARE = 0.25		
<p>33. REMARKS (Attach photograph)</p> <p>Tunnel is two lanes, and highway is four lanes. Bore of tunnel is larger than portals. lighting: artificial, but inoperative. Access panels in tunnel could be used for demolitions.</p>			
DD FORM 3012 (BACK), DEC 2015			

Figure B-5. Sample DD Form 3012 (continued)

Legend:	
ATP	Army techniques publication
attn	attention
DA	Department of the Army
DD	Department of Defense
Dec	December
Jul	July
km	kilometer
MCWP	Marine Corps warfighting publication
PA	Pennsylvania
SFC	Sergeant First Class
TRADOC	United States Army Training and Doctrine Command

Figure B-5. Sample DD Form 3012 (continued)

DD FORM 3013

B-9. Use DD Form 3013 to report the technical information collected during ford reconnaissance. Additionally, when the ford reconnaissance is part of a route classification, the ford information is summarized on the route classification overlay. Complete the ford reconnaissance form as shown in figure B-6.

FORD RECONNAISSANCE REPORT					DATE (YYYYMMDD)	
For use of this form, see ATP 3-34.81/MCWP 3-17.4; the proponent agency is TRADOC.					2015-07-01	
TO: (Headquarters ordering reconnaissance) Commander, ATTN: S-2, 21st Engineer Battalion			FROM: (Name, grade and unit of reconnaissance officer) Fred Smith, SFC, Company A, 21st Engineer Battalion			
1. ROUTE NUMBER Virginia 617	2. FROM (Initial point) UT 122864		3. TO (Terminal point) UT 097899		4. DATE/TIME (Of signature) 01143ZJUL15	
5. MAP SERIES NUMBER V734	6. SHEET NUMBER 5561 III	7. GRID REFERENCE		8. FORD NUMBER 001		
		a. TYPE 1:50,000		b. COORDINATES UT 100886		
9. LOCATION FROM NEAREST TOWN				10. CROSSING (Name of stream or other body of water)		
a. DISTANCE 14 km	b. DIRECTION SE	c. NAME OF NEAREST TOWN Fort Belvoir, VA		Accotink Creek		
11. CHARACTERISTICS OF CROSSING						
WATER LEVELS	a. WIDTH	b. DEPTH	c. VELOCITY	d. DATE	e. SEASON OR MONTH(S)	
(1) TODAY	7.3 m	0.5 m	1.5 m/sec	1 Jul 15		
(2) LOW	6.1 m	0.3 m	1.1 m/sec		Fall	
(3) MEAN	7.3 m	0.5 m	1.5 m/sec		Summer	
(4) HIGH	8.4 m	1.8 m	2.2 m/sec			
12. BOTTOM			13. APPROACHES		14. SLOPE RATIO	
<input type="checkbox"/> SAND <input checked="" type="checkbox"/> GRAVEL <input type="checkbox"/> STONE <input type="checkbox"/> OTHER (Specify)			<input type="checkbox"/> FIRM <input type="checkbox"/> SOFT <input checked="" type="checkbox"/> PAVED		3:1	
15. TYPE OF PAVEMENT Bituminous			16. USABLE WIDTH 7.3 m	17. HAZARDS (Flash floods, quicksand and so forth) Unknown		
18. REMARKS (Description of approach roads, guide markers, depth gauges and so forth)						
Bottom is loose ground. Ford bottom is 9.8 m long and 7.3 m wide. Approach conditions on both ends are easy. No guide markers or depth gauge present.						

DD FORM 3013, DEC 2015

REPLACES DA FORM 1251, WHICH IS OBSOLETE.

Adobe Professional X

Figure B-6. Sample DD Form 3013

19. PROFILE	SCALE 1 SQUARE = None	HORIZONTAL <input type="checkbox"/>	VERTICAL <input type="checkbox"/>
20. SITE PLAN (Indicate north arrow and direction of flow)		SCALE 1 SQUARE = None	
21. REMARKS (Attach photograph)			
<p>Ford bottom must be improved for heavy loads.</p>			

DD FORM 3013 (BACK), DEC 2015

Figure B-6. Sample DD Form 3013 (continued)

Legend:	
ATP	Army techniques publication
attn	attention
DA	Department of the Army
DD	Department of Defense
Dec	December
Jul	July
km	kilometer
m	meter
MCWP	Marine Corps warfighting publication
N	North
Rt	route
SE	southeast
sec	second
SFC	Sergeant First Class
TRADOC	United States Army Training and Doctrine Command
VA	Virginia

Figure B-6. Sample DD Form 3013 (continued)

DD FORM 3014

B-10. Use DD Form 3014 to report the technical information collected during ferry reconnaissance. Additionally, when the ferry reconnaissance is part of a route classification, the ferry information is summarized on the route classification. Complete the ferry reconnaissance form as shown in figure B-7, page B-26.

FERRY RECONNAISSANCE REPORT										DATE (YYYYMMDD)		
For use of this form, see ATP 3-34.81/MCWP 3-17.4; proponent agency is TRADOC.										2015-07-01		
TO: (Headquarters ordering the reconnaissance) Commander, ATTN: S-2, 21st Engineer Battalion					FROM: (Name, grade, and unit of reconnaissance officer) Fred Smith, SFC, A Company, 21st Engineer Battalion							
1. ROUTE OR LINE		2. FROM (Initial point)			3. TO (Terminal point)		4. DATE/TIME (Of signature)					
a. HIGHWAY VA 617		b. RAILROAD NA			Lorton, VA		Hoby, MD		011430Z Jul15			
5. MAP SERIES		6. SHEET NUMBER		7. GRID REFERENCE			8. FERRY		9. CLASS			
V734		5661 111		a. TYPE 1:50,000			b. COORDINATES UT134830		1		45	
10. LOCATION FROM NEAREST TOWN					11. CROSSING (Name of stream or body of water)							
a. DISTANCE 8 km		b. DIRECTION East		c. NAME OF NEAREST TOWN Lorton, VA			Potomac River					
12. LIMITING FEATURE (Condition of vessels, terminals, floods, low water, freezing, tides, and so forth.)(Seasons and dates) Freezing likely in winter months.												
13. WATER LEVELS (Depths)				14. CROSSING TIME				15. LENGTH				
a. LOW 3.2 m		b. MEAN 4.7 m		c. HIGH 7.6 m		20 minutes				1 km		
16. VESSEL FEATURES (Attach photographs)												
a. UNITS	b. CONSTRUCTION TYPE	c. PROPULSION METHOD			d. LENGTH	e. BEAM	f. DRAFT	g. TONNAGE		h. CAPACITY		
		(1) TYPE	(2) UNITS	(3) HP				(1) GROSS	(2) NET	(1) PASS	(2) VEHICLE	(3) RAILROAD CARS
2	Open	Diesel	2	610	22.5 m	1.6 m	1.6 m	85	85	200	8 maximum	NA
17. TERMINAL FEATURES												
a. DIRECTION OF BANK		b. NAME		c. SLIP			d. DOCKING FACILITIES	e. APPROACHES				
				(1) WIDTH	(2) DEPTH	(3) CAPACITY		(1) HIGHWAY		(2) RAILROAD		
								(a) SURFACE	(b) LANES	(c) CLASS	(a) TRACKS	(b) SIDING
N E S W N		Little Reno		13.2	3 m	1	Good	Asphalt	2	45	NA	NA
N E S W N		Angels Point		14 m	4 m	1	Good	Concrete	2	55	NA	NA
18. REMARKS (Amplify above details. Note obstructions, navigational, and other pertinent data.) Anchorage uses 30.5 centimeters piles spaced approximately 10 meters center to center.												

DD FORM 3014, DEC 2015

REPLACES DA FORM 1252, WHICH IS OBSOLETE.

Adobe Designer 9.0

Figure B-7. Sample DD Form 3014

19. ROUTE ALIGNMENT PLAN (Indicate route, terminals, approaches, obstructions, navigational aids, direction of current, and north arrow.)		SCALE 1 SQUARE = None
20. TERMINAL VIEWS (Indicate slips, piling, and direction of bank.)		
BANK (Circle or X) N E X W N	SCALE 1 SQUARE = None	BANK (Circle or X) N E X S W N
21. REMARKS (Attach photograph.) None.		

DD FORM 3014 (BACK), DEC 2015

Figure B-7. Sample DD Form 3014 (continued)

Legend:	
ATP	Army techniques publication
attn	attention
DA	Department of the Army
DD	Department of Defense
Dec	December
E	east
km	kilometer
m	meter
MCWP	Marine Corps warfighting publication
MD	Maryland
N	north
NA	not applicable
S	south
SFC	Sergeant First Class
TRADOC	United States Army Training and Doctrine Command
VA	Virginia
W	west

Figure B-7. Sample DD Form 3014 (continued)

DD FORM 3015

B-11. Use DD Form 3015 to report the technical information collected during an engineer resource assessment. Additionally, the engineer reconnaissance report can be used to report other significant engineer information not covered by any of the other reports in this appendix. Complete the engineer reconnaissance form as follows (see figure B-8):

- **Heading.** Self-explanatory.
- **Key.** The key references the item of the report and its corresponding location on the map overlay. The object serial number (or critical point number) is entered in this column.
- **Object.** Shown by a conventional symbol (see figure B-9, page B-31) or a brief written description.
- **Work estimate.** If a work estimate is included as part of the report, enter yes; if not, enter no.
- **Additional Remarks.** In this column, report the object location by grid coordinates followed by remarks, calculations, and sketches. Make this information as detailed as possible to alleviate the necessity for an additional reconnaissance.
- **Work estimate.** The work estimate is on page 2 of DD Form 3015. Each work estimate is keyed by a serial or critical point number to the appropriate object on the reverse side of the form. Only the appropriate columns need be completed. Draw additional sketches when necessary. (See figure B-8.)

ENGINEER RECONNAISSANCE REPORT				
For use of this form, see ATP 3-34.81/MCWP 3-17.4, proponent agency is TRADOC.				
1. OPORD NUMBER AND NAME Commander, ATTN: S-2, 21st Engineer Battalion		2. RECONNAISSANCE LEADER (Name, grade, unit) Fred Smith, SFC, Company A, 21st Engineer Battalion		3. LOCATION / DTG OF RECONNAISSANCE 3 OF 4 PAGES
4. MAPS / COUNTRY / SHEET NUMBER / NAME / SERIAL NUMBER / EDITION Quantico, Virginia / USA / - Sheet 5561 III				5. SCALE 1:50,000
6. HEADQUARTERS ORDERING RECONNAISSANCE				
a. KEY	b. OBJECT	c. TIME OBSERVED	d. WORK ESTIMATE	e. ADDITIONAL REMARKS AND SKETCH
	Bivouac area	1015	No	UT 512692 - Possible bivouac area. 700 m x 900 m Good access roads with adequate drainage and hard surface. Adequate site drainage.
		1035	No	UT 553680 - Possible water point. Quantity: ~ 8,000 GPM Quality: Cloudy, no odor No observed source of contamination, sample collected for testing Site condition: Firm soil, gradual slope, possible bivouac site available nearby
<i>Engineer work estimate on reverse side.</i>				
7. TYPED NAME, GRADE, ORGANIZATION Fred Smith SFC, Company A, 21st Engineer Battalion			8. SIGNATURE	

DD FORM 3015, DEC 2015

REPLACES DA FORM 1711, WHICH IS OBSOLETE.

Adobe Designer 9.0

Figure B-8. Sample DD Form 3015

9. ENGINEER WORK ESTIMATE									
a. LOCATION KEY	b. DESCRIPTION OF WORK	c. UNIT REQUIRED	d. NUMBER OF REQUIRED HOURS	e. EQUIPMENT			f. MATERIALS		
				(1) TYPE	(2) NUMBER	(3) HOURS	(1) TYPE	(2) UNIT	(3) QUANTITY
⚠	Remove obstacle from Route 132	1 - Squad	2	Sec	1	2	Aggregate	CY	5

SAMPLE

Reconnaissance report on front side.

DD FORM 3015 (BACK), DEC 2015

Legend:

ATP Army techniques publication
attn attention
DA Department of the Army
DD Department of Defense
m meter
MCWP Marine Corps warfighting publication
Nov November
SFC Sergeant First Class
TRADOC United States Army Training and Doctrine Command
USA United States of America

Figure B-8. Sample DD Form 3015 (continued)















Sawmill		Iron and steel stock	
Lumber yard		Wire stock	
Stone		Paint	
Aggregate (including gravel and slag)		Glass stock	
Sand		Gypsum and lime products	
Cement concrete products		Asphalt and bituminous stock	
Stocks of bricks and other clay products		Stocks of roof covering	

Figure B-9. Engineer resource symbols





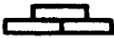









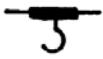

Building hardware		Mobile, heavy-construction equipment	
Industrial gases		Forestry equipment	
Cordage, nets, yarns		Quarrying equipment	
Civil-engineering firms		Handling and transportation equipment storage	
Building contractors		Powered hand tools	
Factories		Water-purification equipment (civilian)	
Factory symbol plus plant product		Electrical supply equipment	
Steel-rolling mills and foundries		Established military water point	
Engineering workshops		Possible military water point	

Figure B-9. Engineer resource symbols (continued)

DA FORM 2203

B-12. Use DA Form 2203 to report the technical information collected during demolition reconnaissance. Complete the demolition reconnaissance record as described in FM 3-34.214/MCRP 3-17.7L. This form is marked with the appropriate security classification statement when completed. No markings are required for training purposes.

DD FORM 3016

B-13. Use DD Form 3016 to report the technical information collected during river reconnaissance. Additionally, when the river reconnaissance is part of a route classification, the river information is summarized on the route classification overlay. Complete the river reconnaissance form as shown in figure B-10.

RIVER RECONNAISSANCE REPORT					DATE ORDERED (YYYYMMDD)	
For use of this form, see ATP 3-34.81/MCWP 3-17.4; the proponent agency is TRADOC.					2015-07-24	
RECONNAISSANCE OFFICER/NCO (Name, Rank, Unit)			ORGANIZATION ORDERING RECONNAISSANCE			
Commander, ATTN: S-2, 536th Engineer Battalion			Mark A. Wilson, SFC, A Company, 536th Engineer Battalion			
1. ROUTENUMBER OR NAME	2. FROM (Initial point)	3. TO (Terminal point)	4. DATE/TIME OF COMPLETION			
AP Hill 004	TT 945209	TT938180	29 0800 Jul 15			
5. MAP SERIES NUMBER	6. SHEET NUMBER	7. GRID COORDINATES	8. OPORD NUMBER/NAME			
V7345	5560 III	1:50,000 TT 945185	1			
9. LOCATION FROM NEAREST TOWN			10. CROSSING (Name of river or other body of water)			
a. DISTANCE	b. DIRECTION	c. NAME OF NEAREST TOWN		Cattlet Creek		
2 km	SW	Collins Crossing				
11. CHARACTERISTICS OF NEARSHORE						
a. BANKHEIGHT	b. BANK SLOPE	c. BANK STABILITY	d. BANK SOIL TYPE	e. MINES	f. OBSTACLES (Type)	
1.8 m	6 percent	Firm	Grass	None	None	
g. SLOPE TO DEPTH OF 2M		h. SOIL TYPE TO DEPTH OF 2M	i. MINES TO DEPTH OF 2M	j. OBSTACLES TO DEPTH OF 2M		
10 percent		Soft mud	None	None		
12. CHARACTERISTICS OF RIVER						
a. GAP WIDTH	b. VELOCITY (m/sec)	c. FLOW DIRECTION	d. BOTTOM COMPOSITION (Mud, sand, gravel; hard-packed or soft)			
143 m	1.5 mps	SW	1/4 GAP soft mud 1/2 GAP soft mud 3/4 GAP soft mud			
e. MAXIMUM DEPTH		f. ANCHORAGE SUITABILITY (Describe)		g. OBSTACLES		
1/4 GAP 12 ft	1/2 GAP 18 ft	Very good/recommend using kedge anchors		None		
3/4 GAP 10 ft						
13. CHARACTERISTICS OF FARSHORE						
a. BANKHEIGHT	b. BANK SLOPE	c. BANK STABILITY	d. BANK SOIL TYPE	e. MINES	f. OBSTACLES (Type)	
0.8 m	9 percent	Firm	Grass	None	None	
g. SLOPE TO DEPTH OF 2M		h. SOIL TYPE TO DEPTH OF 2M	i. MINES TO DEPTH OF 2M	j. OBSTACLES TO DEPTH OF 2M		
9 percent		Soft mud	None	Stump located at 3 ft		
14. REMARKS (Describe the farshore and nearshore approaches, assembly areas, available cover and concealment, and overall assessment of crossing-site potential for freezing over or flooding.)						
Nearshore approach is about 150 meters wide with firm soil and grass, but no overhead cover.						
For shore approach is about 80 meters wide with firm soil and grass.						
Note: Stump located 3 feet, measuring 26 inches in diameter. Stump needs to be moved before far shore can be used.						
Crossing site has no history of flooding, but has potential for freezing over in late January through March.						

DD FORM 3016, DEC 2015

REPLACES DA FORM 7398, WHICH IS OBSOLETE.

Adobe Designer 9.0

Figure B-10. Sample DD Form 3016

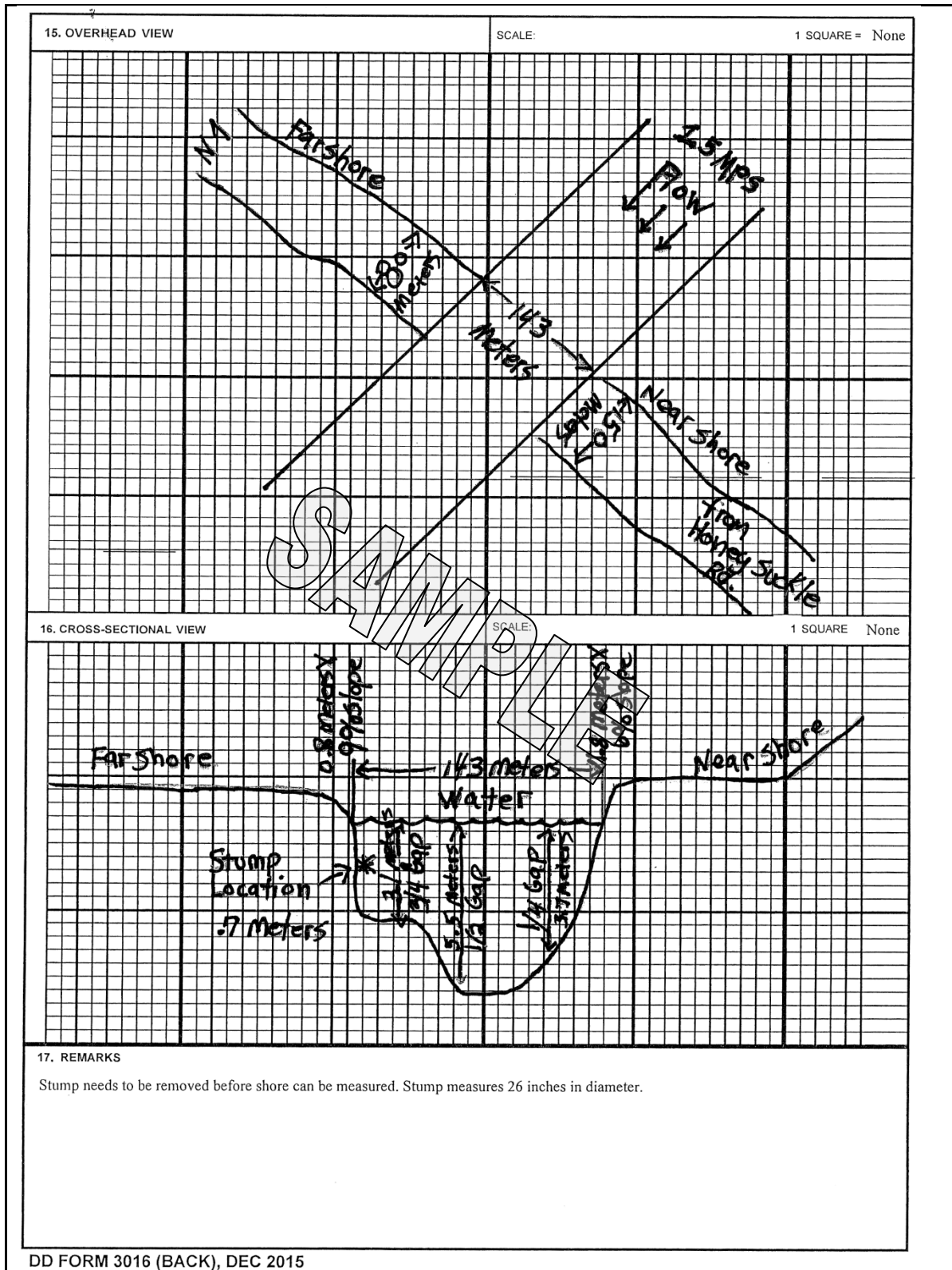

Figure B-10. Sample DD Form 3016 (continued)

Legend:	
ATP	Army techniques publication
attn	attention
DA	Department of the Army
DD	Department of Defense
Dec	December
ft	feet
fps	feet per second
Jul	July
km	kilometers
m	meter
MCWP	Marine Corps warfighting publication
mps	meters per second
SFC	Sergeant First Class
SW	southwest
TRADOC	United States Army Training and Doctrine Command

Figure B-10. Sample DD Form 3016 (continued)

NORTH ATLANTIC TREATY ORGANIZATION AGREEMENTS

B-14. NATO nations have concluded a number of agreements on a wide range of engineer matters, which are regularly reviewed. More subject areas are under negotiation. This section provides a summary of the standardization agreements of relevance to engineer reconnaissance. The list of standardization agreements relevant to engineer reconnaissance is shown below with the custodians shown in parenthesis:

- STANAG 2010.
- STANAG 2017.
- STANAG 2021.
- STANAG 2036.
- STANAG 2143.
- STANAG 2221.
- STANAG 2282.
- STANAG 2369.
- STANAG 2370.
- STANAG 2394.
- STANAG 2929.
- STANAG 2989.
- STANAG 2991.

This page intentionally left blank.

Appendix C

Infrastructure Reconnaissance

This appendix provides a quick reference for collecting and reporting technical information from the major categories of infrastructure and several other categories of infrastructure. This appendix provides a guide for the collection of relevant information.

ASSESSMENT

C-1. The infrastructure assessment and the infrastructure survey are two stages of infrastructure reconnaissance used to gather the necessary infrastructure information. The purpose of the assessment is to provide immediate feedback concerning the status of the basic services necessary to sustain the local population. The memory aid to describe this assessment is SWEAT-MSO; each of the letters describes a major area within the assessment. (See figure C-1.) The model can be adapted for use at the tactical level in stability or civil support operations. Not all considerations will be assessed during initial entry, but they will be assessed as operations stabilize. The infrastructure assessment and survey model can be used during course of action development to delineate tasks, missions, and effects that support civil-military related objectives. The ERT may also include specialized additive reconnaissance elements tasked with humanitarian aid assessments that are not related to brigade level military operations.

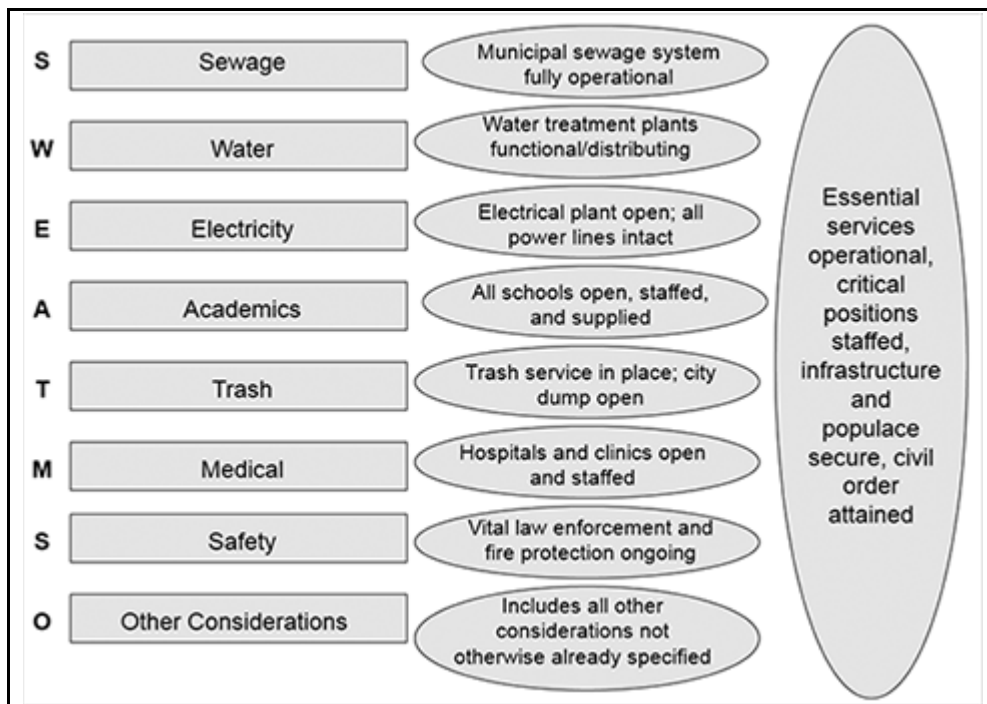

Figure C-1. The infrastructure assessment and survey model

C-2. The basic services or categories evaluated depend on the situation, mission, and commander's intent. While the assessment is typically performed by engineers, it may be accomplished by others when an engineer is not available, depending on the expertise available and the desired type and quality of information

required. If available, leaders should also consult military and nongovernmental organizations, units, and agencies in the area to determine if there are extenuating circumstances that may influence the outcome of the assessment. Typically, engineer planners use this information to define immediate needs and determine priorities of work. While an infrastructure assessment is designed to support the resolution of the immediate challenges, it will normally set the conditions for a successful transition. Some of the primary considerations for the assessment are—

- **Sewage.** What is the status of the local sewage system? What health and environmental risks exist?
- **Water.** What potable water sources are available? Are they adequate? Have they been tested?
- **Electricity.** What is the status of electrical generation facilities, to include availability of generators? What is the status of the transmission infrastructure? What critical facilities (hospitals, government buildings, schools) are not having their needs met? What is the availability of fuel for transportation, heating, and cooking? Is there an adequate system of distribution?
- **Academics.** What schools are in need of repair and rebuilding?
- **Trash.** Is there a system in place for removing waste? What hazardous waste streams are being generated that may have detrimental impacts on health and the environment? What is the ultimate disposal system for trash?
- **Medical.** Are medical services available and operational? Does an emergency service exist? Are veterinarian services available for animals?
- **(Public) Safety.** Is there a police and fire service? Are explosive hazards or other hazards an issue?
- **Other considerations.** Other considerations that leaders may consider as a part of the assessment include—
 - **Transportation networks.** Are roads, bridges, and railroads trafficable? Is the airport operational? Do helicopter landing sites exist and are they useable? Can they sustain the local humanitarian assistance traffic?
 - **Fuel distribution.** Is there a fuel distribution system available to commercial and residential customers?
 - **Housing.** Are the homes structurally sound and habitable? Do they include basic utilities?
 - **Explosive hazards.** Are ordnance hazards observed?
 - **Environmental hazards.** Are environmental hazards observed?
 - **Communications.** Is the telephone network available and operational? Does the town have television, radio, and newspaper access; if so, do they work?
 - **Places of worship.** Are there adequate facilities to support religious activities for all groups?
 - **Attitude.** Are local people and community leaders supportive? Is there ethnic tension?

C-3. The USACE provides handbooks, which are used to execute infrastructure reconnaissance assessments and surveys. Examples of infrastructure assessment and survey criteria can be found at the [Reachback Engineer Data Integration Smartcard Web site](#). (See the Web site section of the references for a Web site address.). Table C-1 provides an example of the type of information gathered during the initial infrastructure assessment of a town or location. This information will be used to determine the humanitarian and civic assistance needs of the location. These considerations are not intended to be all-inclusive, but rather another aid to support an assessment. The formal survey will be more specific and in-depth than the information in any assessment. Survey smartcards support the conduct of a survey. Table C-1 uses the SWEAT-MSO model to assist personnel in organizing an assessment strategy. Leaders may use these resources to begin developing priorities, obtaining resources, and refining a plan. Many of the tasks derived from this process will be general engineering tasks (facilities construction, well drilling, power generation, road repair). Focus on the areas described by SWEAT-MSO, and annotate key city official points of contact. The physical location of the reconnaissance should also be collected and reported. Recommend priorities and any key official recommendation for priority.

Table C-1. Infrastructure assessment considerations

Area of Assessment		Considerations
S	Sewage System	<ul style="list-style-type: none"> • Status of municipal sewage systems or distribution systems • Status of sewage systems in commercial or residential properties • Determination of immediate needs
W	Water	<ul style="list-style-type: none"> • Status of water treatment plants or distribution systems • Status of potable water in commercial or residential properties • Status of storage capacity • Determination of location and capacity of wells • Determination of immediate needs
E	Electricity	<ul style="list-style-type: none"> • Status of electric plants or distribution systems • Status of electric power in commercial or residential properties • Determination of alternate power sources • Determination of immediate needs
A	Academics	<ul style="list-style-type: none"> • Status of school buildings • Status of teachers and supplies • Determination of immediate needs
T	Trash	<ul style="list-style-type: none"> • Status of trash collection systems • Status of disposal sites • Determination of immediate needs
M	Medical	<ul style="list-style-type: none"> • Status of hospitals or clinic buildings • Status of physicians and supplies • Determination of immediate needs
S	(Public) Safety	<ul style="list-style-type: none"> • Status of police and fire departments • Status of safety personnel and supplies • Determination of immediate needs
O	Other Considerations	
	Transportation System	<ul style="list-style-type: none"> • Status of road system conditions (include sketches if needed) • Impact on critical transportation needs • Determination of immediate needs
	Fuel Distribution	<ul style="list-style-type: none"> • Status of fuel distribution systems • Status of storage capacity • Determination of immediate needs
	Housing	<ul style="list-style-type: none"> • Status of structures • Status of utilities • Determination of immediate needs
	Explosive Hazards	<ul style="list-style-type: none"> • Explosive ordnance locations and types (send nine-line EH report as required by the mission) • Status of explosive ordnance markings (if yes, marking description) • Determination of immediate needs
	Environmental Hazard	<ul style="list-style-type: none"> • Status of existing and known hazards (describe) • Status of known, visible chemicals on the ground (describe) • Status of abandoned manufacturing buildings (are waste products/streams contained?) • Determination of immediate needs
	General	<ul style="list-style-type: none"> • Status of population (male and female) • Status of religious denominations • Status of ethnic breakdown

SURVEY

C-4. Infrastructure reconnaissance is accomplished in two stages—

- The infrastructure assessment.
- The infrastructure survey.

C-5. As a follow-on to the assessment, the infrastructure survey provides a detailed description of the condition of major services. The primary difference between the assessment and the survey is the degree of technical information and the expertise required and available to perform the reconnaissance. The survey is normally conducted by forward U.S. Army Corps of Engineers personnel assigned or attached to a forward engineer support team. The survey team integrates with other technical specialties (medical, civil affairs) to enhance the quality of the survey. A large urban area may require more than one survey team to accomplish the necessary breadth of survey requirements. A survey may also require that the area be secure for it to be performed while the assessment may be performed in an area that is not secured yet. The survey and the assessment are best performed when other branch specialties are available to support the base engineer element.

Appendix D

Military Load Classification

The basis for MLC is the effect (load, vehicle speed, tire width) a vehicle has on a bridge when crossing. Heavy loads (artillery, tanks) make vehicle classification an important factor when determining bridge capacity and classifying the overall trafficability of a route.

CLASSIFICATION NUMBER REQUIREMENTS

D-1. Classification numbers are mandatory for self-propelled vehicles having a total weight of 3 short tons or more and trailers with a payload of 1 1/2 short tons or greater (in compliance with STANAG 2010 and STANAG 2021). Trailers with a rated capacity of less than 1 1/2 short tons are usually combined with their towing vehicle for classification.

D-2. The MLC information is found in the vehicle technical manual or on the vehicle data plate. Because units do not have the same vehicle types and characteristics, the organization table of equipment vehicle information should be incorporated into the unit SOP as a quick reference table. This information will serve as a quick reference for ERTs when assigned the mission to classifying bridges for crossing with unit equipment. When working with multinational partners, vehicle characteristics should also be considered before assigning limiting characteristics to the capacity of a bridge or route. The MLC determination for crossing vehicles over unsigned bridges can be found in TM 3-34.22/MCRP 3-17.1B.

VEHICLE CLASSIFICATION REQUIREMENT

D-3. The mathematical computation of a vehicle MLC is beyond the scope of this publication. If a requirement to determine a vehicle classification exists, when time allows, classification is requested through reachback by supplying the dimensions of the vehicle in question and requesting computation of the MLC number. Requests for classification of vehicles should be sent directly to the U.S. Army Tank Automotive Research, Development, and Engineering Center; ATTN: AMSRD-TAR-D/BRDG MS#21; 6501 East 11 Mile Road; Warren, MI 48397-5000 or via commercial telephone at (800) 574-5608.

D-4. The Teleengineering Emergency Operations Center can be reached by e-mail at <uroc@usace.army.mil>, the [Reachback Operations Center Web site](#), and commercial telephone at (601) 634-2735/3485 or (877) 223-8322 and Defense Switched Network telephone at (312) 446-2735 or (312) 466-3485.

D-5. Requests for classification that do not include all of the necessary information may not be met. Some of the data may be obtained from the vehicle weight and dimension card (see STANAG 2021) that is displayed by vehicles during transport. The following information must be listed:

- Weight (empty, loaded for cross-country, and loaded for highway).
- Load on each axle (empty, loaded for cross-country, and loaded for highway).
- Load on lunette, pintle, or fifth wheel (empty, loaded for cross-country, and loaded for highway).
- Tires (number per axle, size, and inflation pressure).
- Distance between axles.
- Distance from nearest axles to pintle, lunette, or fifth wheel.
- Outside-to-outside width of tires or tracks and inside-to-inside width of tires or tracks.
- Length of track in contact with the ground.
- The national stock number, if available.

TEMPORARY PROCEDURES FOR VEHICLE CLASSIFICATION

D-6. Temporary vehicle classification numbers may be assigned under special conditions. Sometimes military vehicles carry loads that are more than or less than their normal payloads. In this case, a temporary vehicle MLC number may need to be assigned. The classification number assigned increases or decreases by an amount equal to the overload or underload.

D-7. It is sometimes necessary to classify a vehicle under field conditions. This may be done in one of two ways. A temporary MLC may be assigned through comparison with a similarly classified vehicle or through the expedient classification procedure. In both cases, the using unit must verify the classification quickly.

VEHICLE COMPARISON

D-8. For all vehicles, a comparison of the unclassified vehicle may be made by comparing the axle loads, gross weight, and dimensions of the unclassified vehicle with those of a similar classified vehicle. If no comparable vehicle is available, then use the expedient vehicle classification.

EXPEDIENT VEHICLE CLASSIFICATION

D-9. This expedient procedure to estimate the MLC is available and effective when the situation requires an immediate determination. During the classification process, vehicles are divided into two categories and calculated accordingly. The categories are vehicles with trailers (vehicle combination class number) and without trailers (single vehicle classification number).

D-10. When a vehicle tows another vehicle at a distance less than 30.5 meters and the vehicles are not designed to operate as one unit, the combination is referred to as a nonstandard combination. A temporary vehicle MLC number may be assigned to this combination. The classification number assigned is nine-tenths the sum of the normal vehicle classification numbers if the total of both classifications is less than 60. If the sum of the two military classification numbers is 60 or over, the total becomes the MLC number for the nonstandard combination. See the following formula:

$$CCN = 0.9 (A + B) \text{ if } A + B < 60$$

$$CCN = A + B \text{ if } A + B > 60$$

where—

A = class of first vehicle
B = class of second vehicle
CCN = combination class number

D-11. The expedient classification for a wheeled vehicle is estimated to be 85 percent of its total weight. Therefore, the vehicle gross weight must be determined. Multiply the air pressure in the tires (in pounds per square inch) by the total area (in square inches) of the tires in contact with the ground. If a gauge is not available, use 75 pounds per square inch as an average value. This yields an approximate weight of the vehicle in pounds. The following formula shows the expedient classification:

$$WT = AT \times PT \times NT \div 2,000$$

= 0.85 estimated classification (wheeled vehicles)

where—

WT = gross weight of vehicle (short tons)
AT = average tire contact area (hard surface) (square inches)
PT = tire pressure (pounds per square inch)
NT = number of tires

D-12. Tracked vehicles weigh about one short ton per square foot of track that makes contact with the ground. By determining the area of track that is in contact with the ground, the vehicle gross weight can be assigned. The estimated classification equals the gross weight of the vehicle in short tons for tracked vehicles. In the case of vehicles that weigh a fraction over whole tonnage, the next higher classification number is assigned.

D-13. A wheeled vehicle MLC for a flexible surface road can be estimated using the bearing capacity determined in chapter 4 (see figure 4-20, page 4-22). Classification numbers and their relationship to wheel loads are shown in table 4-8, page 4-25. Since the maximum allowable single wheel load for vehicles from 50 to 120 is the same (20,000 pounds), the load class for roads in this range relies on a determination of the single axle load, which exceeds the scope of this publication. Normally, road classification for tracked vehicles is not assigned.

This page intentionally left blank.

Appendix E

Technical Tools and Resources

This appendix highlights some of the most useful and primary support tools for engineers performing general engineering operations. This type of reachback capability is one of the characteristics of field force engineering. The U.S. Air Force and U.S. Navy provide some of the same type of capabilities and support through the Air Force Civil Engineering Support Agency and the Naval Facilities Engineering Command. (See FM 3-34 for further information.)

ENGINEER RESEARCH AND DEVELOPMENT CENTER

E-1. The U.S. Army Corps of Engineers Engineer Research and Development Center consists of seven laboratories at four geographical sites. The research and development supports the Department of Defense, other federal agencies, and the nation in military and civilian projects. Their primary mission areas include—

- Warfighter support.
- Installation support.
- Environment support.
- Water resources.
- Information technology.

E-2. Research projects include facilities, airfields, pavements, protective structures, sustainment engineering, environmental quality, installation restoration (cleanup), compliance and conservation, regulatory functions, flood control, navigation, recreation, hydropower, topography, mapping, geospatial data, winter climatic conditions, oceanography, environmental impacts, and information technology.

PROTECTIVE DESIGN CENTER

E-3. The U.S. Army Corps of Engineers Protective Design Center is the Army Center of Expertise for security engineering and structures hardened to resist weapon effects. The Protective Design Center employees are considered experts in their specialties.

E-4. The Protective Design Center director co-chairs the committee that wrote the Department of Defense minimum antiterrorism construction standards and that writes many of the Department of Defense security engineering unified facilities criteria documents. These unified facilities criteria present design guidance for protective systems against aggressor tactics, to include—

- Explosive hazards.
- Indirect weapons fire.
- Direct weapons fire.
- CBRN.

E-5. The Protective Design Center has experience assisting units with vulnerability assessments and using software and other tools to determine where facility hardening is required. Their engineers can identify vulnerabilities and recommend mitigating measures, including vehicle barriers to achieve standoff distance and structural hardening to resist weapons effects.

REACHBACK OPERATIONS CENTER

E-6. The U.S. Army Corps of Engineers Reachback Operations Center provides a reachback engineering capability enabling Department of Defense personnel deployed worldwide to talk directly with experts in the

United States when a problem in the field needs quick resolution. Deployed troops are linked to subject matter experts within the government, private industry, and academia to obtain solutions to complex field problems.

E-7. The Reachback Operations Center staff members respond to incoming information requests (flooding potential due to dam breaches; load carrying capacities of roads and bridges; field fortifications and force protection; design and repair of airports, port facilities, bridges, dams, railroads, and roadways; evaluation of transportation networks). The Reachback Operations Center provides comprehensive training and support to deployed units, and it maintains a data repository for collected engineering data used for infrastructure analysis. Informational reports on conducting infrastructure reconnaissance can be found on the [Reachback Engineer Data Integration Web site](#).

TELEENGINEERING COMMUNICATIONS EQUIPMENT-DEPLOYABLE

E-8. The Teleengineering Communications Equipment-Deployable provides reachback capability using off-the-shelf satellite communications equipment with added security encryption. Video teleconferences and data transfers can be conducted from remote sites where normal communications are unavailable.

TELEENGINEERING TOOLKIT

E-9. The Teleengineering toolkit software is a valuable analysis tool for the graphical display of engineer products, analyses, and digital data. The ARRK combines the power of the Teleengineering toolkit with a global positioning system, video camera, and three-dimensional accelerometers to provide a mounted vehicle or airborne automated route reconnaissance capability. This system has supported numerous military operations and natural disaster response missions.

GEOSPATIAL ASSESSMENT TOOL

E-10. The geospatial assessment tool for the Engineering Reachback Program provides rapid data collection for assessing critical infrastructure (SWEAT-MSO), real property, environmental condition reports, environmental base closures, access control points, explosive ordnance disposal, civil affairs, and special operations weather team collections. The U.S. Army Corps of Engineers Reachback Operations Center provides comprehensive training and support to units and maintains a repository for collected data and data migration to the Secure Internet protocol router.

AUTOMATED ROUTE RECONNAISSANCE KIT

E-11. The ARRK provides military units with an adaptable, easy-to-use reconnaissance package that allows an ERT or other engineer reconnaissance element to rapidly collect and process reconnaissance (all types but generally route reconnaissance) information.

E-12. The ARRK uses a field-ready laptop computer that continuously collects reconnaissance information without stopping or leaving the vehicle for routine calculations. Time, security, and accuracy issues normally associated with route reconnaissance are reduced. The ARRK collects pictures, voice recordings, global positioning system locations, and accelerometer and gyroscope data streams in three dimensions. Unlike the traditional, manually recorded route reconnaissance efforts, the ARRK allows an operator with minimum training and experience to collect, process, and export route information. The ARRK accommodates a chronological picture replay of the route and geo-referenced display of major features that affect the classification and usage of the road or route. The viewer of the data can scroll through the stored data types to locate specific features along the route instantly. Data includes automated determination of slope, radius of curvature, and ride quality. The reconnaissance data collected from the ARRK is quickly converted by the operator to a preformatted report that follows the requirements of this publication. Planned improvements for the system include integration of a laser range finder and digital scale reference guide. The system will be developed as a stand-alone data collection tool and a fully interoperable data collection platform for dissemination and repository of route information.

RECONNAISSANCE AND SURVEYING INSTRUMENT SET

E-13. The ENFIRE is a digital tool set used by engineers to execute combat and construction reconnaissance and surveys. (See figure E-1, page E-4.) The ENFIRE provides the engineer with the capability to perform rapid reconnaissance, reporting, and dissemination of this information up the chain of command. The ENFIRE automatically populates field data on the forms used for reconnaissance reporting, with relevant information from peripheral devices included in the ENFIRE set. The information collected is transferable between the tablet personal computer and other digital systems through the personal geodatabase transfers or joint variable message format messages created using the common operating environment message processor. Some of the information gathered will be disseminated through the battle command common services server. The ENFIRE also contains a variety of existing commercial off-the-shelf and government off-the-shelf software packages for additional functionality. More functions of the ENFIRE include—

- Nine-line improvised explosive device/unexploded ordnance report.
- Bridge reconnaissance report.
- Road reconnaissance report.
- Route reconnaissance report.
- Hasty minefield report.
- Simplified survivability assessment tool to determine bunker shelter requirements.
- SoftPlan© to design structures and generate a bill of materials.
- TerraModel® to model the contours of a landscape to determine cut and fill requirements and requirements for materials.
- Microsoft® Office tools.
- Theater Construction Management System.

WATER DETECTION RESPONSE TEAM

E-14. The objective of the water detection response team is to reconnoiter potential areas for the best quality of water within the available drilling equipment capability and to meet the water production requirements of the mission. The water detection response team is the Department of Defense prime organization for assisting military well drillers, whether for military, humanitarian, or nation-building activities. Its primary function is to assist and advise well-drilling teams on the location of the best well-drilling sites and depths and to provide information on drilling conditions for logistical planners. A staff of ground water experts is on call to provide information and assistance and to produce studies for military well-drilling related activities. The team possesses remote sensing and geophysical equipment, and the team has numerous bibliographic sources readily available for most areas of the world. The water detection response team also offers a Hydrogeology for Military Well Drillers short course upon request.

DEFENSE ENVIRONMENT NETWORK AND INFORMATION EXCHANGE

E-15. The Defense Environmental Network and Information Exchange is an electronic environmental bulletin board accessible throughout the Department of Defense. It gives environmental, safety, and occupational health managers a central communications platform to gain timely access to vital environmental information.

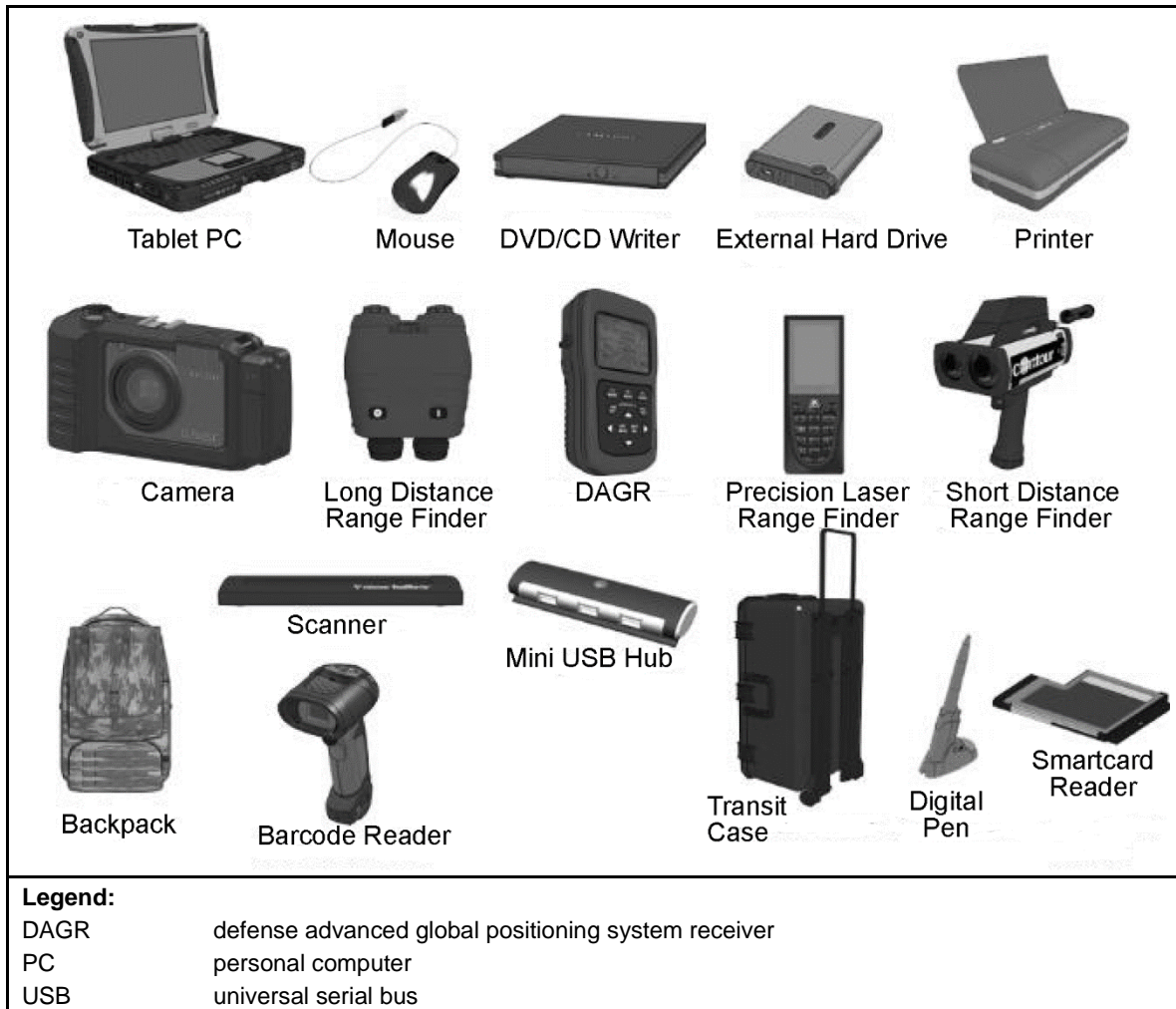

Figure E-1. ENFIRE components

E-16. The Defense Environmental Network and Information Exchange (based on the Army Defense Environmental Electronic Bulletin Board System) gives users the ability to—

- Read online environmental publications (proprietary or Department of Defense specific).
- Send or receive mail electronically on the Defense Environmental Network and Information Exchange host computer or across the internet.
- Exchange environmental information via managed discussion forums based on a subject area.
- Send or receive the required reporting data through the chain of command.
- Peruse and request environmental training courses and seminars.
- Access the Defense Environmental Network and Information Exchange directory service database.
- Upload and download files from the Defense Environmental Network and Information Exchange to and from a personal computer.

UNITED STATES ARMY CENTER FOR HEALTH PROMOTION AND PREVENTIVE MEDICINE

E-17. The U.S. Army Center for Health Promotion and Preventive Medicine has a mission to provide worldwide technical support for implementing preventive medicine, public health, and health promotion and wellness services into all aspects of the Army and the Army community. The U.S. Army Center for Health

Promotion and Preventive Medicine anticipates and rapidly responds to operational needs and adapts to a changing world environment. The U.S. Army Center for Health Promotion and Preventive Medicine organization is headquartered at Aberdeen Proving Ground, Maryland, with subordinate commands in Landstuhl, Germany, and Sagami, Japan. The U.S. Army Center for Health Promotion and Preventive Medicine also maintains subordinate commands at three locations in the United States (Fort Meade, Maryland; Fort McPherson, Georgia; and Fort Lewis, Washington).

E-18. The U.S. Army Center for Health Promotion and Preventive Medicine is a linchpin of medical support to combat forces and of the military managed-care system. The U.S. Army Center for Health Promotion and Preventive Medicine provides worldwide scientific expertise and services in clinical and field preventive medicine, environmental and occupational health, health promotion and wellness, epidemiology and disease surveillance, toxicology, and related laboratory sciences. It supports readiness by keeping Soldiers and Marines fit to fight, while also promoting wellness among their families and the Federal civilian workforce. Professional disciplines represented include chemists, physicists, engineers, physicians, optometrists, epidemiologists, audiologists, nurses, industrial hygienists, toxicologists, entomologists, and subspecialties within these professions.

This page intentionally left blank.

Appendix F

Signs

Posting signs at bridges and at other constrictions or key locations along a route promotes efficient traffic control and limits the impact of hazardous areas along the route. Signs are used when it is necessary to identify special controls placed on a bridge or route section; to warn vehicle operators of hazardous areas or conditions; and to identify holding areas, turnouts for parking and unloading vehicles, and checkpoints. Procedures for posting military routes are standardized for the United States and Allied Nations. However, this system may be integrated into other road sign systems according to military requirements.

Note. This appendix implements STANAG 2454.

ROUTE SIGNS

F-1. There are three general types of standard route signs (hazard, regulatory, and guide). Table F-1 lists the way each type is used. Their size is not prescribed; however, they must be large enough to be easily read under poor lighting conditions. Exceptions to this rule are bridge classification signs for which dimensions are specified. Signs for civil international road use are usually not less than 16 inches square.

Table F-1. Typical hazard, regulatory, and guide signs

	<i>Type</i>		
	<i>Hazard</i>	<i>Regulatory</i>	<i>Guide</i>
Application	Advance warning of stop signs and traffic signals	No entry	Detour
	Changes in road width	One way	Detour begins
	Crossroad	Parking restrictions	Detour ends
	Curves	Specific regulations for vehicles	Directions
	Danger or hazard	Speed limit	Distances
	Dangerous corner	Stop	Information to help driver
	Dips	Bridge classification	Locations
	T-Junction		Route number
	Y-Junction		
	Level railroad crossing, advance warning		
	Men working		
	Railroad crossing		
	Road construction repairs		
	Road narrows		
	Slippery road		
	Steep grades		
	Steep hill		
	Turns		

HAZARD SIGNS

F-2. Hazard signs indicate traffic hazards and require coordination with civil authorities. Hazard signs are square and are installed in a diamond position. (See figure F-1 and figure F-2.) A military hazard sign has a yellow background with the legend or symbol inscribed in black. The wording on these signs is in the language or languages determined by the authority erecting the sign. (See FM 3-34.210/MCRP 3-17.2D for information on explosive hazard signs.)

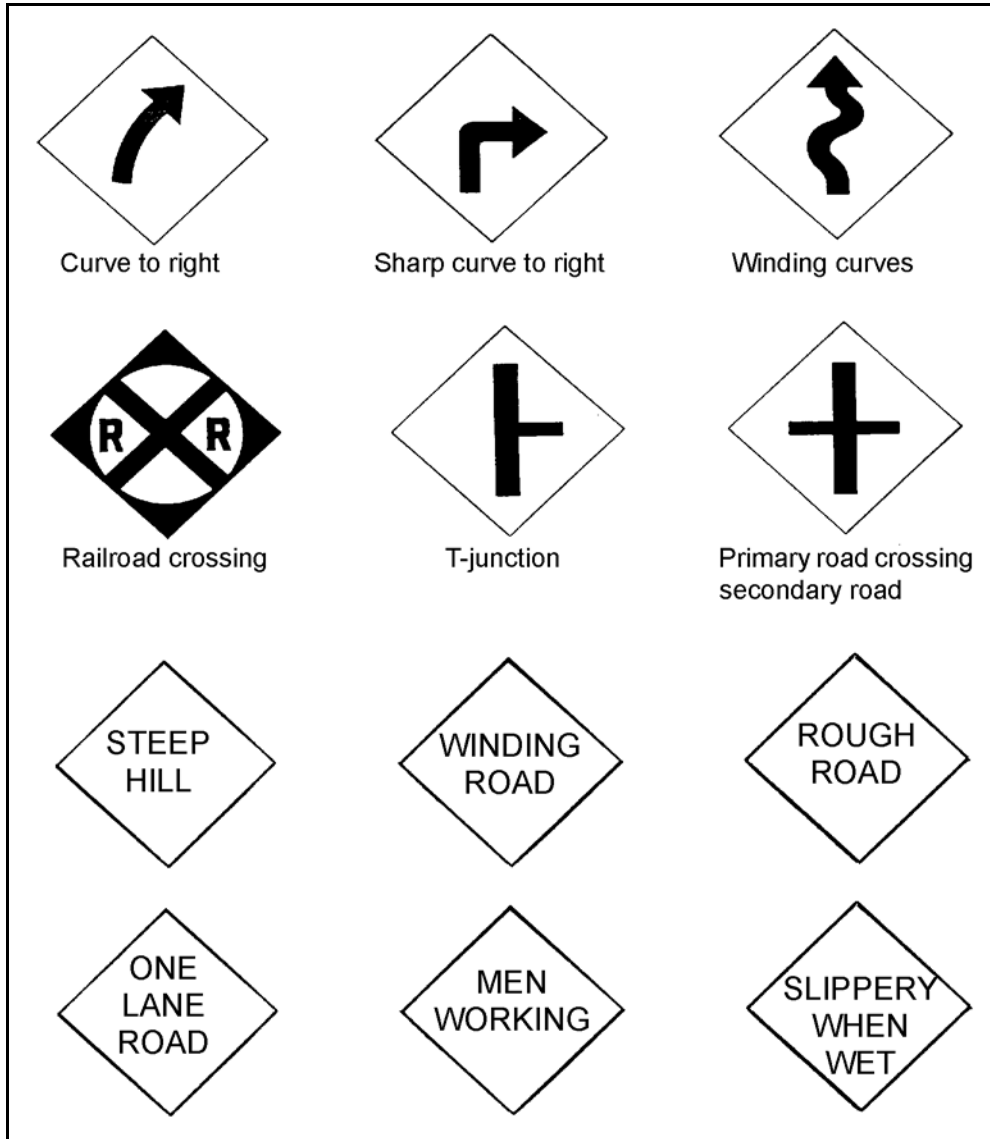

Figure F-1. Hazard signs not included in the Geneva Convention

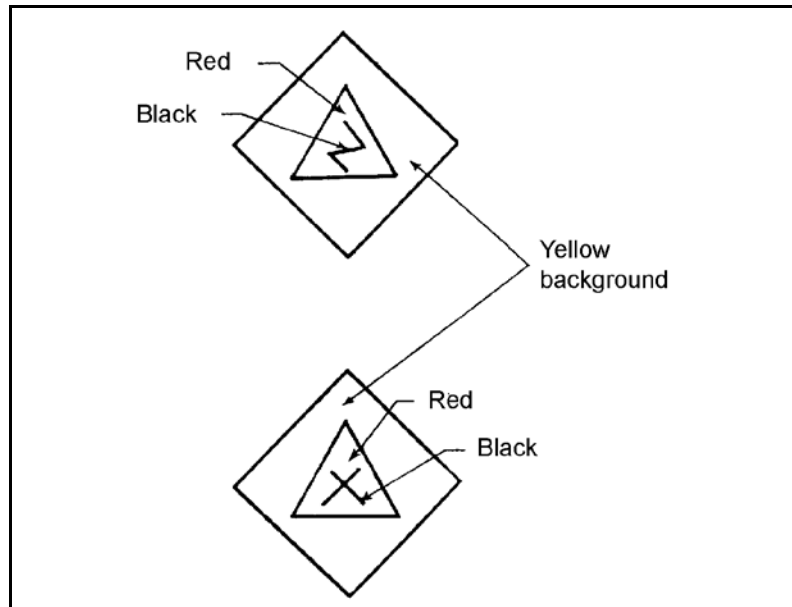

Figure F-2. Hazard signs included in the Geneva Convention

REGULATORY SIGNS

F-3. Regulatory signs regulate and control traffic. Regulatory signs include enforcement and warning signs. Warning signs are placed in advance of the enforcement sign to provide vehicle operators with advance notice of the enforcement area. Examples of regulatory signs include bridge classification signs, stop signs, no-entry signs, and signs that define the light line (the line where vehicles must use blackout lights at night). Regulatory signs have a black background on which the legend or symbol is superimposed in white.

Note. Exceptions to these rules are bridge classification signs, stop signs, no-entry signs, and signs that apply to civil and military traffic. Check with civilian authorities to ensure compliance when erecting signs in areas with civilian traffic.

F-4. Examples of regulatory signs are shown in figure F-3. Two warning signs are located, allowing for the terrain, before the enforcement sign. Place the first warning sign 200 to 500 meters before the regulatory sign.

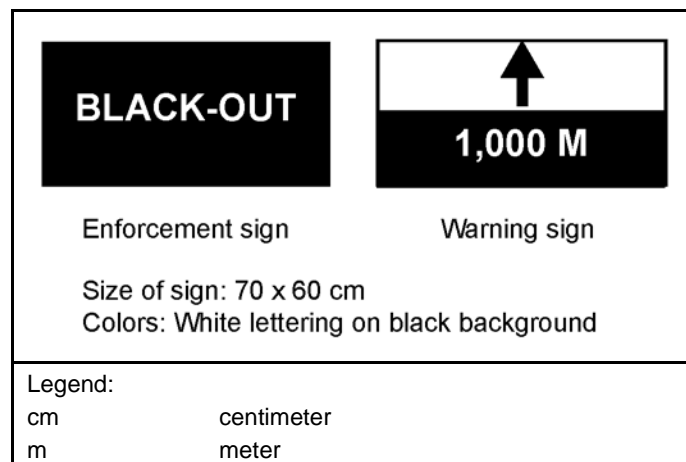

Figure F-3. Warning and enforcement signs

Bridge and Raft Signs

F-5. All classified vehicles and bridges in the theater of operations require classification signs. Bridge signs are circular with yellow background and black inscriptions. Sign diameters are a minimum of 40 centimeters for one-lane bridges and 50 centimeters for two-lane bridges. (See figure F-4.) A two-lane bridge has two numbers, side by side, on the sign. The number on the left is the bridge classification when both lanes are in use at the same time. The number on the right indicates the classification if the bridge is carrying one-way traffic and the vehicles proceed along the centerline of the bridge.

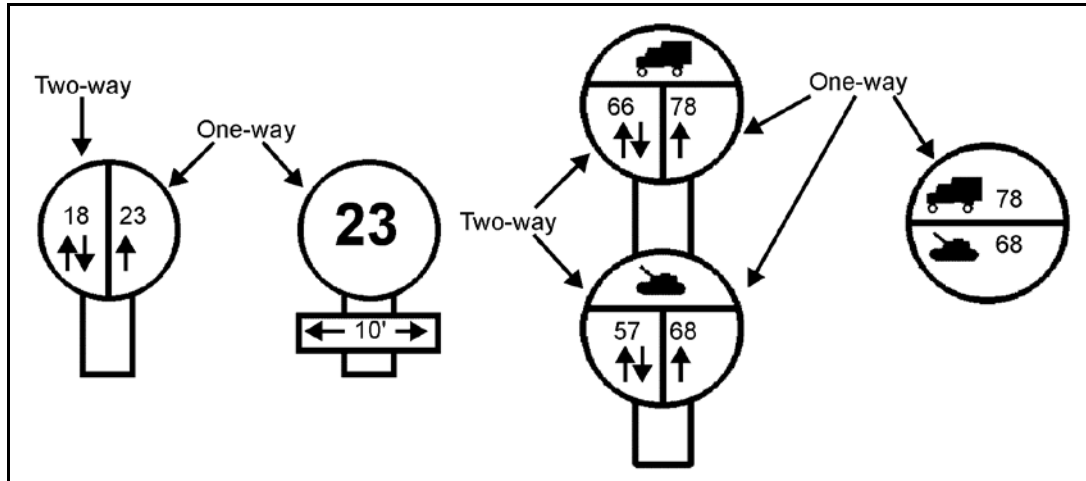

Figure F-4. Bridge signs

F-6. For bridges with separate classifications for wheeled and tracked vehicles (dual classification), use a special circular sign that indicates both classifications (only applicable if the classification is over 50). (See the right side of figure F-4.) Use a separate rectangular sign, if necessary, to show the bridge width limitations. For one-way or two-way traffic bridges, the sign should be a minimum of 50 centimeters.

Rectangular Bridge Signs

F-7. Additional instructions and technical information are posted on rectangular signs, which are a minimum of 41 centimeters in height or width and have a yellow background with the appropriate letters and symbols in black. Write the figures as large as the sign permits. Theater commanders may make special arrangements to indicate vehicles of exceptional width or to indicate low overhead obstructions. Use separate signs to show the width or height limitations (see figure F-5) or technical information (see figure F-6). Width and height signs are not required on bridges where existing civilian signs are in place and sufficiently clear.

Width and Height Restrictions

F-8. TM 3-34.22/MCRP 3-17.1B lists minimum roadway width restrictions for bridge classifications. If a one-lane bridge does not meet width requirements, post a rectangular warning sign under the classification sign to show the clear width (see figure F-5). If this is a route restriction, annotate it in the route classification format. For a two-lane bridge, downgrade the two-way classification to the highest class for which it does qualify (one-way class is not affected). Post a limited-clearance sign if the overhead clearance is less than 4.3 meters. These signs must be a minimum of 3 to 5 meters in height or width, with a yellow background, and the appropriate description in black letters. Separate rectangular signs are used (if necessary) to denote width limitations, height limitations, or other technical information. The same signs are used for tunnels, if applicable.

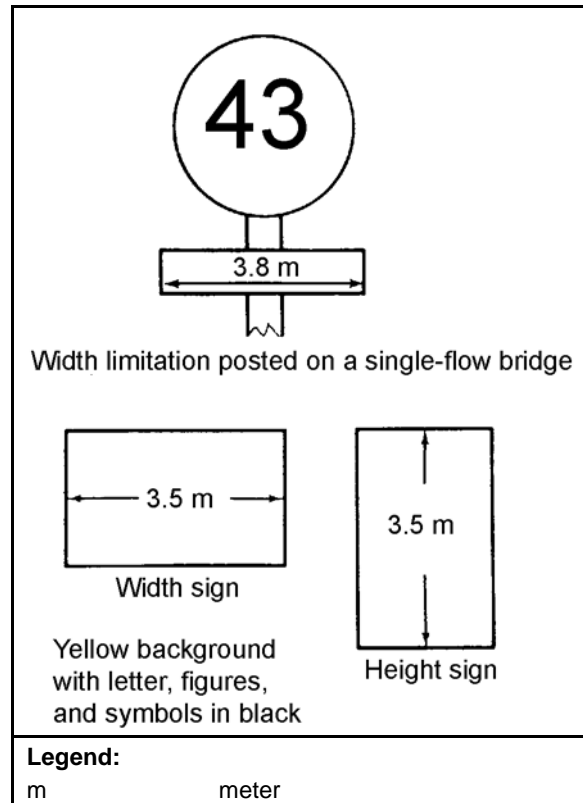

Figure F-5. Width and height signs

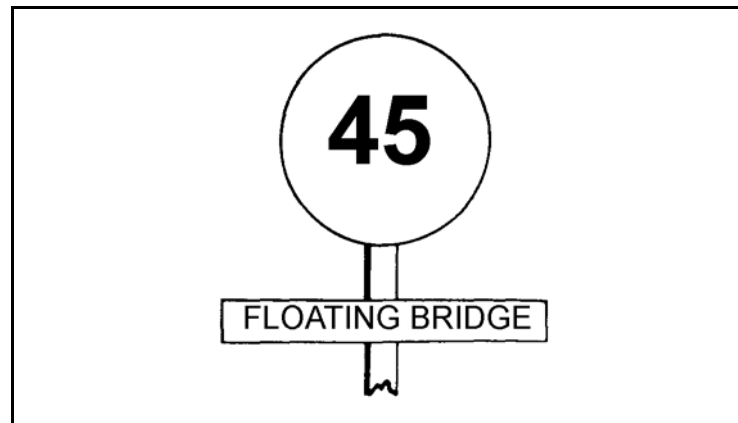

Figure F-6. Bridge sign containing technical information

Multilane Bridge Signs

F-9. Bridges of three or more lanes are special cases that require individual consideration; the minimum widths for respective load classifications are used. See TM 3-34.22/MCRP 3-17.1B for a full explanation of bridge MLC. In some cases, heavier loads can be carried on a restricted lane rather than on the other lanes. (See figure F-7, page F-6, and figure F-8, page F-6.) Under such circumstances, post standard bridge classification signs for each lane and mark the restricted lanes with barricades, painted lines, or studs.

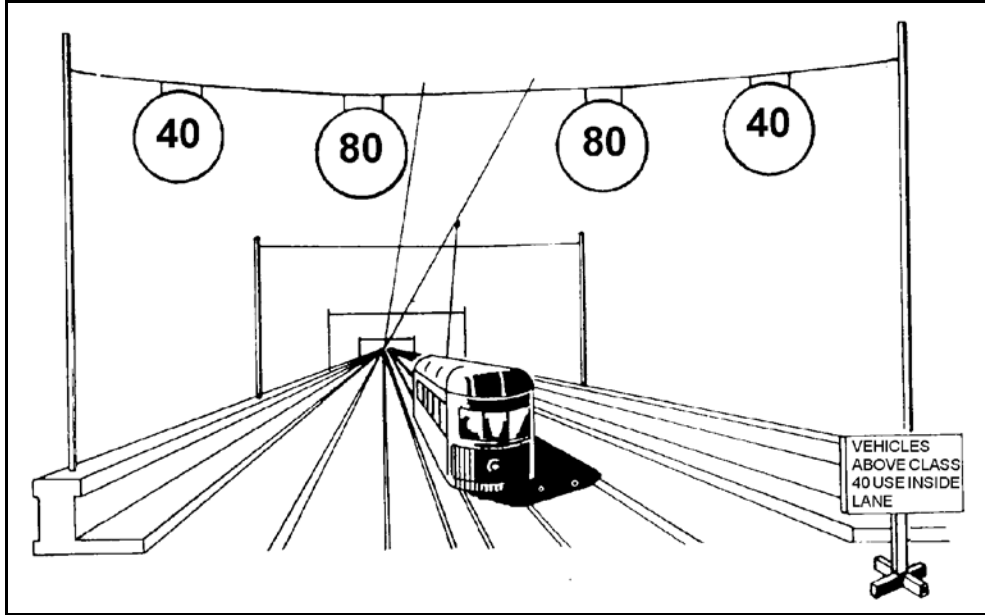

Figure F-7. Typical multilane bridge classification

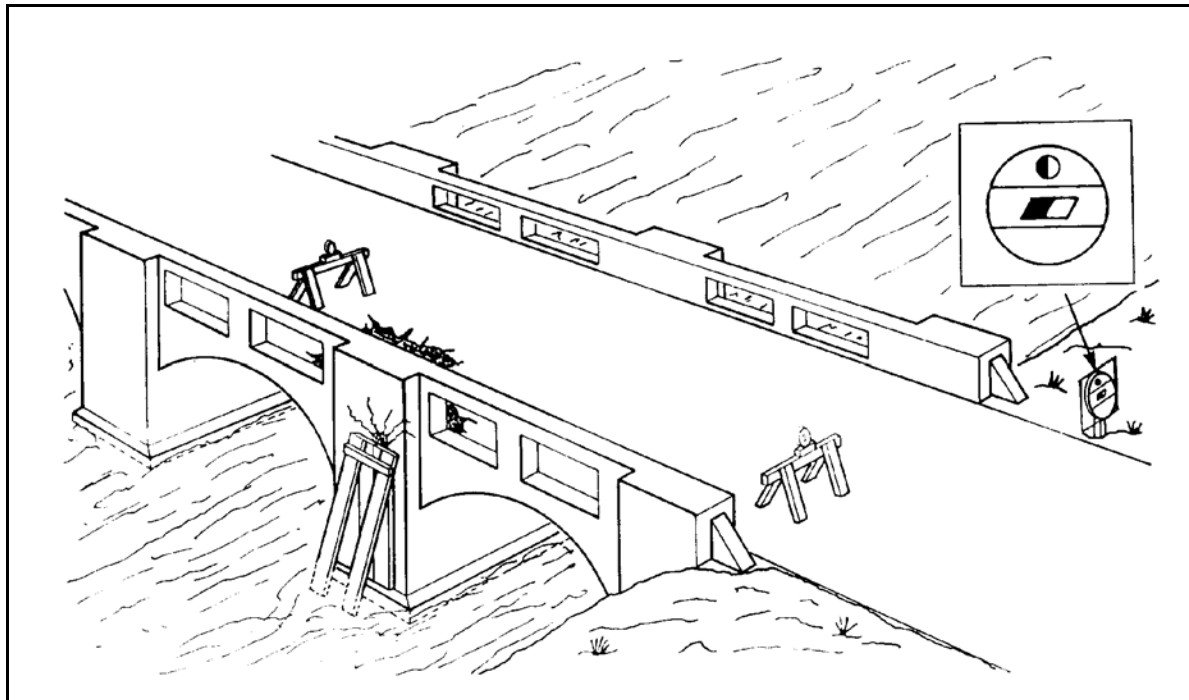

Figure F-8. Indicators of a damaged bridge

Bridge Sign Placement

F-10. Ensure that signs are placed properly (as listed below) to maintain uninterrupted traffic across a bridge:

- The bridge classification sign is placed at both ends of the bridge in a position that is clearly visible to all oncoming traffic.
- Rectangular signs, other than those indicating height restrictions, are placed immediately below the bridge classification (circular) signs.

- Signs that indicate height restrictions are placed centrally on the overhead obstruction.
- Special classification numbers are never posted on standard bridge-marking signs.
- Appropriate advance warning signals are placed on bridge approaches, as required.

GUIDE SIGNS

F-11. Guide signs indicate direction or location. These signs consist of the military route number and the appropriate directional disk. If standard signs are not available, construct military route guide signs by placing a directional disk over a rectangular panel on which the route number is inscribed. (See figure E-9.)

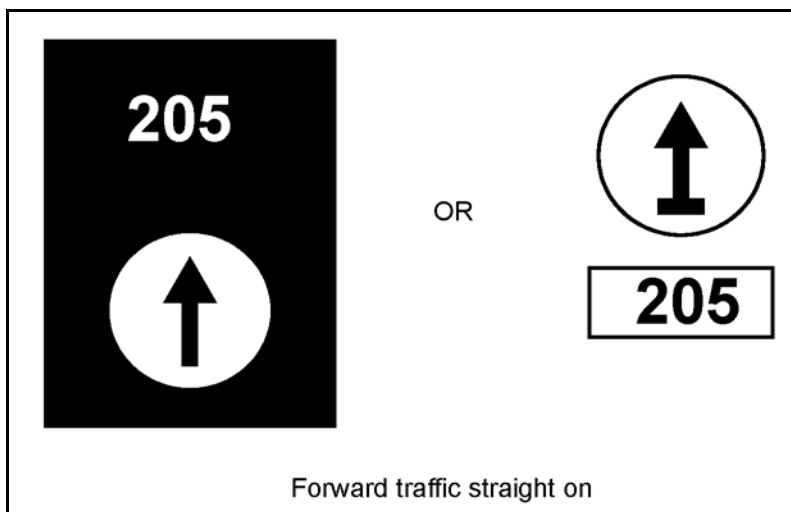

Figure F-9. Military route guide signs for axial routes

Directional Disks

F-12. A directional disk consists of a fixed, black arrow (with or without a bar) on a white background. Eight equally spaced holes around the edges of the circumference allow the disk to be nailed with the arrow pointing in the desired direction. These disks are no smaller than 12 inches in diameter. (See figure F-10, page F-8.) They are used as standard guide signs to indicate military axial and lateral routes. Directional disks may be used together with unit signs to indicate direction to locations of major units (groups and above). Smaller units may not use directional disks. However, any arrow sign that provides a different shape and color from the standard direction disks can be used to indicate smaller units.

Headquarters and Logistical Signs

F-13. Headquarters and logistical signs mark a headquarters and logistical installation. Use the appropriate military symbol. (See MIL-STD 2525C.) The inscription is black on a yellow background. This symbol may be supplemented by national distinguishing symbols or abbreviations. For division headquarters and above, nationality is always indicated. Colors other than black or yellow are prohibited, except for national distinguishing symbols.

Casualty Evacuation Route Signs

F-14. Indicate casualty evacuation routes on rectangular signs. (See figure F-11, page F-8.) The signs have a white background with red inscriptions of a directional arrow, a red cross (except for Turkey who has a red crescent), and a unit or subunit designation (if required). An alternate sign may be made from a white disk with four segments cut in the shape of an X. The inscriptions are shown in red.

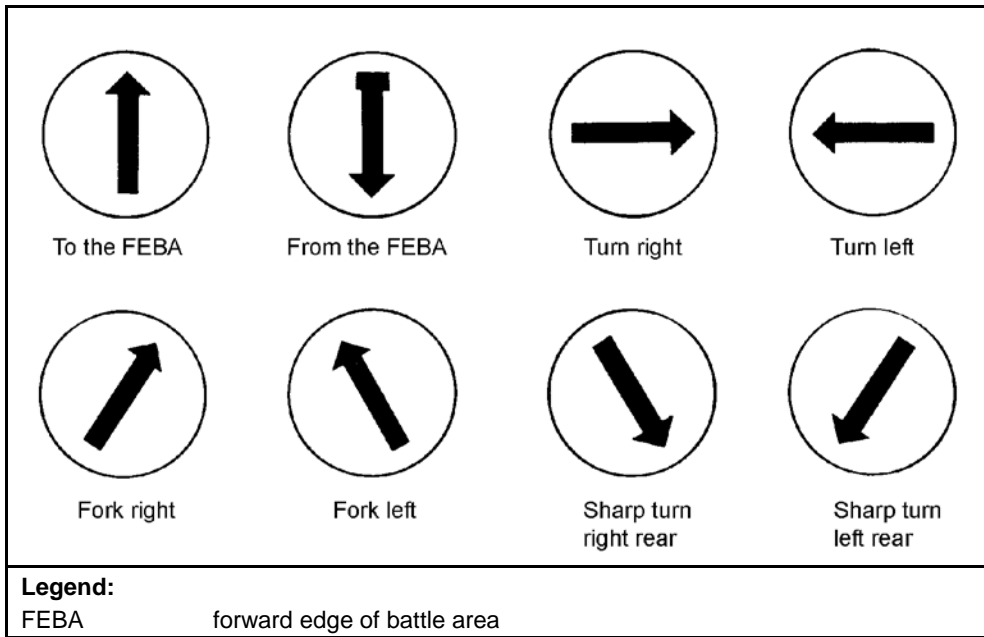

Figure F-10. Directional disks

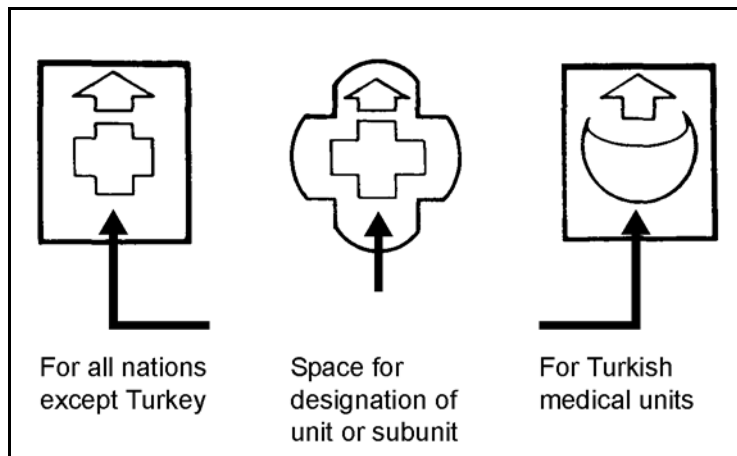

Figure F-11. Guide signs for casualty evacuation routes

Unit Direction Arrow

F-15. Use temporary unit direction arrows to mark march routes and include the unit identification symbol as part of the inscription. (See figure F-12.) Unit route signs are placed in advance of the moving column and are picked up by a trail vehicle.

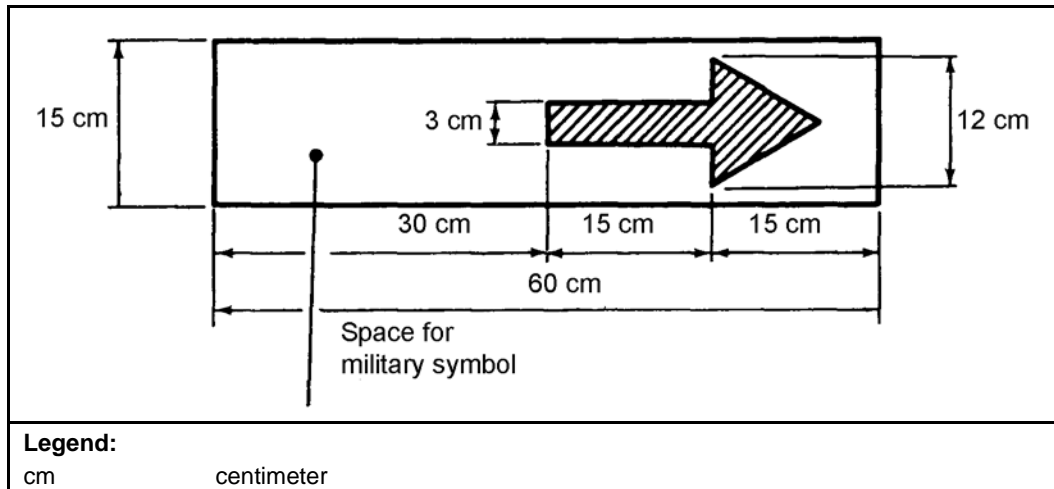

Figure F-12. Unit direction arrow

Military Detour Signs

F-16. Military detour signs consist of a white arrow superimposed on a blue square. Place the sign in a diamond position. (See figure F-13.) Show the number of the diverted route by placing the number on the square over the arrow or placing the number on a small panel under the square.

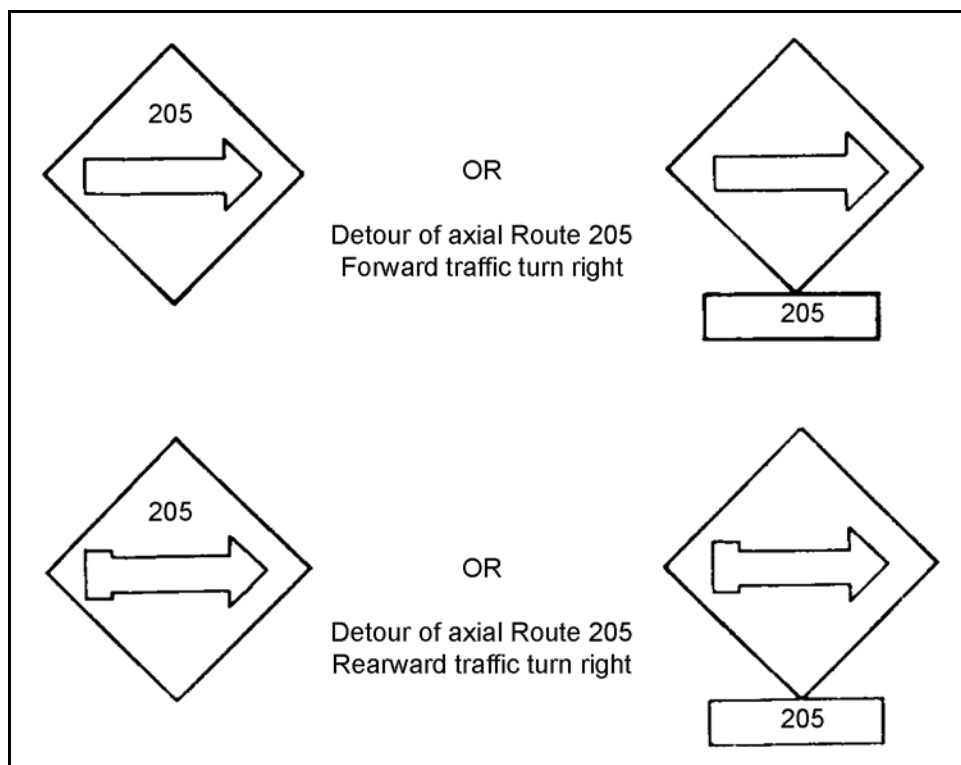

Figure F-13. Military detour signs

ROAD MARKERS IN AREAS OF HEAVY SNOW

F-17. Posting road signs in areas of heavy snowfall requires special attention. Ensure that the markers are placed evenly on both sides of the traveled way. In open country, use poles of appropriate height with direction markers, snow markers, or flags. Place markers at least one meter off the traveled way to avoid traffic damage. If you cannot completely mark a road, place arrow signs at prominent points to indicate road direction. Road markers and signs used for a long period in areas of heavy snow should be checked frequently to ensure that their positions have not altered. In areas with prolonged conditions of snow, yellow (international orange) may be substituted for white on standard military route signs.

VEHICLE SIGNS

F-18. There are two types of vehicle signs:

- **Front.** Use front signs on vehicles, except trailers, to show the classification of the laden vehicle.
- **Side.** Use side signs on towing vehicles and trailers only to show the classification of the laden towing vehicles or trailers by themselves.

F-19. Front and side signs are circular and marked in contrasting colors consistent with camouflage requirements. Black figures on a yellow background may be used.

F-20. The front sign is 23 centimeters in diameter. Place or paint the front sign on the front of the vehicle, above or on the bumper, and below the driver's line of vision. When possible, place it on the right side, facing forward.

F-21. The side sign is 15 centimeters in diameter. Place or paint the side sign on the right side of the vehicle, facing out.

F-22. Make the inscription on the sign as large as the sign allows. The front sign, except on towing vehicles and tank transporters, indicates the vehicle laden solo class. On towing vehicles, the front sign indicates the combined load class of the train. Above this number, write the letter C to distinguish the vehicle as a towing vehicle. (See figure F-14.) On tank transporters and similar type vehicles, the fixed front sign shows the maximum classification of the laden vehicle. One alternative front sign may be carried. Place the sign so that it covers the fixed front sign, when necessary, to show the class of the vehicle when unladen. The side sign (used only by prime movers of combination vehicles and trailers) indicates the laden solo class of the prime mover or trailer.

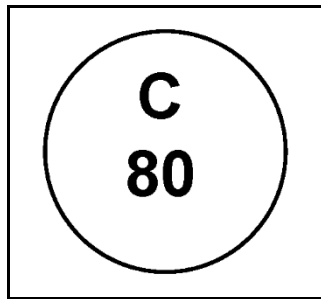

Figure F-14. Front sign

F-23. Single vehicles (including tank transporters) carry the front sign only; towing vehicles carry front and side signs; and trailers carry side signs only. Mark all vehicles as shown in paragraphs F-19 through F-22. (See appendix D for details on determining the vehicle MLC.) Marking vehicles of a gross weight of 3.048 short tons or less or trailers with a rated capacity of 1.524 short tons or less is optional.

SIGN LIGHTING

F-24. The appropriate military authority in the area specifies which signs are to be illuminated. Primary considerations go to hazard and direction signs. The system of lighting must remain operational for a minimum of 15 hours without refueling or changing batteries. Consider the following:

- Under normal conditions, each armed force is responsible for ensuring that standard signs are visible at night and other periods of reduced visibility. Take necessary precautions, however, during combat operations.
- Under reduced lighting conditions, the positioning of the signs and the methods adopted to make them visible (illumination or reflection) must enable personnel to see them from vehicles fitted with reduced lighting or filtering devices.
- In a blackout zone, signs are equipped with upper shields that prevent light from being directly observed from the air. The light illuminating the sign is of such low intensity that it is not possible to locate the sign from the air at altitudes greater than 150 meters by its reflection off the road surface. Illumination devices are positioned so that they can be recognized by oncoming vehicles at a road distance of 100 meters and read at a distance of 80 meters.

This page intentionally left blank.

Glossary

The glossary lists acronyms and terms with Army or joint definitions. Where Army and joint definitions differ, (Army) precedes the definition. Terms for which this publication is the proponent are marked with an asterisk (*).

SECTION I – ACRONYMS AND ABBREVIATIONS

AAP	Allied Administrative Publication
AO	area of operations
AR	Army regulation
ARRK	automated route reconnaissance kit
ATP	Army techniques publication
attn	attention
BCT	brigade combat team
CBRN	chemical, biological, radiological, and nuclear
DA	Department of the Army
DC	District of Columbia
DD	Department of Defense form
EOD	explosive ordnance disposal
ERT	engineer reconnaissance team
FACE	forward aviation combat engineering
FM	field manual
JP	joint publication
LOA	limit of advance
LD	line of departure
M/CM/S	mobility, countermobility, and survivability
MAGTF	Marine air-ground task force
MCRP	Marine Corps reference publication
MCWP	Marine Corps warfighting publication
METT-T	mission, enemy, terrain and weather, troops and support available, time available
METT-TC	mission, enemy, terrain and weather, troops and support available, time available, civil considerations
MI	Michigan
MLC	military load classification
MO	Missouri
MOG	maximum (aircraft) on the ground
MSCoE	Maneuver Support Center of Excellence
NAI	named area of interest

NATO	North Atlantic Treaty Organization
No.	number
O&M	operation and maintenance
RCT	regimental combat team
RP	release point
S-2	intelligence staff officer
S-3	operations staff officer
SOP	standard operating procedure
SP	start point
STANAG	standardization agreement
SWEAT-MSO	sewage, water, electricity, academics, trash, medical, safety, and other considerations
TM	technical manual
U.S.	United States
UAS	unmanned aircraft system
UFC	unified facilities criteria
USMC	United States Marine Corps

SECTION II – TERMS

***infrastructure reconnaissance**

A multidisciplinary reconnaissance focused on gathering technical information on the condition and capacity of existing public systems, municipal services, and facilities within an assigned area of operations.

References

REQUIRED PUBLICATIONS

ADRP 1-02. *Terms and Military Symbols*. 7 December 2015.

JP 1-02. *Department of Defense Dictionary of Military and Associated Terms*. 8 November 2010.

RELATED PUBLICATIONS

These documents contain relevant supplemental information.

ARMY

Most Army publications are available online at <www.apd.army.mil>.

ADP 3-0. *Unified Land Operations*. 10 October 2011.

ADRP 5-0. *The Operations Process*. 17 May 2012.

ADRP 6-0. *Mission Command*. 17 May 2012.

ATP 3-39.10. *Police Operations*. 26 January 2015.

ATTP 3-06.11. *Combined Arms Operations in Urban Terrain*. 10 June 2011.

FM 3-34. *Engineer Operations*. 2 April 2014.

FM 3-90-2. *Reconnaissance, Security, and Tactical Enabling Tasks Volume 2*. 22 March 2013.

FM 3-97.6. *Mountain Operations*. 28 November 2000.

FM 6-0. *Commander and Staff Organization and Operations*. 5 May 2014.

FM 27-10. *The Law of Land Warfare*. 18 July 1956.

JOINT

Most joint publications are available online at <www.dtic.mil/doctrine/new_pubs/jointpub.htm>.

JP 3-15. *Barriers, Obstacles, and Mine Warfare for Joint Operations*. 17 June 2011.

JP 3-34. *Joint Engineer Operations*. 30 June 2011.

MARINE CORPS

Most Marine Corps publications are available online at <<https://www.doctrine.usmc.mil>> or <<https://www.doctrine.usmc.mil/currentPubsListing.asp>>.

MCWP 3-17. *Engineering Operations*. 14 February 2000

MCWP 3-21.1. *Aviation Ground Support*. 16 October 2001.

MCWP 5-1. *Marine Corps Planning Process*. 24 August 2010.

MULTI-SERVICE

ATP 3-34.5/MCRP 4-11B. *Environmental Considerations*. 10 August 2015.

ATP 3-37.34/MCWP 3-17.6. *Survivability Operations*. 28 June 2013.

ATP 3-90.8/MCWP 3-17.5. *Combined Arms Countermobility Operations*. 17 September 2014.

ATTP 3-90.4/MCWP 3-17.8. *Combined Arms Mobility Operations*. 10 August 2011.

ATTP 3-97.11/MCRP 3-35.1D. *Cold Region Operations*. 28 January 2011.

FM 3-34.210/MCRP 3-17.2D. *Explosive Hazards Operations*. 27 March 2007.

FM 3-34.214/MCRP 3-17.7L. *Explosives and Demolitions*. 11 July 2007.

- FM 5-430-00-1/AFJPAM 32-8013. *Volume I, Planning and Design of Roads, Airfields, and Heliports in the Theater of Operations—Road Design*. 26 August 1994.
- FM 5-430-00-2/AFJPAM 32-8013. *Volume II, Planning and Design of Roads, Airfields, and Heliports in the Theater of Operations—Airfield and Heliport Design*. 29 September 1994.
- FM 90-3/FMFM 7-27. *Desert Operations*. 24 August 1993.
- TM 3-34.22/MCRP 3-17.1B. *Military Nonstandard Fixed Bridging*. 17 October 2013.
- TM 5-820-1/AFM 88-5, Chapter 1. *Surface Drainage Facilities for Airfields and Heliports*. 20 August 1987.

NATO

Most NATO publications are available at <http://nso.nato.int/nso/#nogo>.

- STANAG 2010. (Edition 6) *Military Load Classification Markings*. 5 March 2004.
- STANAG 2017. (Edition 4) *Orders to the Demolition Guard Commander and Demolition Firing Party Commander (Non-Nuclear)*. 28 January 1999.
- STANAG 2021. (Edition 6) *Military Load Classification of Bridges, Ferries, Rafts, and Vehicles*. 22 May 2014.
- STANAG 2036. (Edition 6) *Land Mine Laying, Marking, Recording and Reporting Procedures*. 27 January 2005.
- STANAG 2143. (Edition 6) *Explosive Ordnance Disposal (EOD) Principles and Minimum Standards of Proficiency*. 5 September 2014.
- STANAG 2221. (Edition 3) *Explosive Ordnance Disposal Reports and Messages*. 3 September 2014.
- STANAG 2282. (Edition 2) *Inter-Service Explosive Ordnance Disposal Operations on Multinational Deployments*. 4 April 2011.
- STANAG 2369. (Edition 3) *The NATO EOD Publications Set—Identification and Disposal of Surface, Air, and Underwater Munitions*. 26 January 2010.
- STANAG 2370. (Edition 3) *Inter-Service Improvised Explosive Device Disposal Operations on Multinational Deployments—A Guide for Staff Officers/Operators*. 3 March 2014.
- STANAG 2394. (Edition 3) *Land Force Combat Engineer Doctrine*. 18 December 2008.
- STANAG 2454. (Edition 3) *Road Movements and Movement Control*. 27 January 2005
- STANAG 2929. *Airfield Damage Repair (ADR)*. 1 March 1994.
- STANAG 2989. (Edition 2) *Transfer of Barriers*. 23 February 2007.
- STANAG 2991. (Edition 4) *NATO Combat Engineer Glossary*. 18 August 2004.

OTHER

- AFPAM 10-1403. *Air Mobility Planning Factors*. 12 December 2011. http://static.e-publishing.af.mil/production/1/af_a3_5/publication/afpam10-1403/afpam10-1403.pdf, accessed on 4 December 2015.
- Fed-Std-376B. *Preferred Metric Units for General Use by the Federal Government*. 27 January 1993. <http://www.nist.gov/pml/wmd/metric/upload/fs376-b.pdf>, accessed on 4 December 2015.
- MIL-STD 2525C. *Common Warfighting Symbolology*. 17 November 2008. http://www.dtic.mil/doctrine//doctrine/other/ms_2525c.pdf, accessed on 4 December 2015.
- UFC 3-260-01. *Airfield and Heliport Planning and Design*. 17 November 2008. http://www.wbdg.org/ccb/DOD/UFC/ufc_3_260_01.pdf, accessed on 4 December 2015.
- UFC 3-260-02. *Pavement Design for Airfields*. 30 June 2001. http://www.wbdg.org/ccb/DOD/UFC/ufc_3_260_02.pdf, accessed on 4 December 2015.
- UFC 3-270-07. *O&M: Airfield Damage Repair*. 12 August 2002. http://www.wbdg.org/ccb/DOD/UFC/ufc_3_270_07.pdf, accessed on 4 December 2015.

UFC 4-141-10N. *Design: Aviation Operation and Support Facilities*. 16 January 2004.
<http://www.wbdg.org/ccb/DOD/UFC/ufc_4_141_10n.pdf>, accessed on 4 December 2015.

PRESCRIBED FORMS

Department of Defense forms are available on the Office of the Secretary of Defense Web site at <www.dtic.mil/whs/directives/infomgt/forms/formsprogram.htm>.

- DD Form 3009. *Route Classification*.
- DD Form 3010. *Road Reconnaissance Report*.
- DD Form 3011. *Bridge Reconnaissance Report*.
- DD Form 3012. *Tunnel Reconnaissance Report*.
- DD Form 3013. *Ford Reconnaissance Report*.
- DD Form 3014. *Ferry Reconnaissance Report*.
- DD Form 3015. *Engineer Reconnaissance Report*.
- DD Form 3016. *River Reconnaissance Report*.

REFERENCED FORMS

Unless otherwise indicated, Department of the Army forms are available on the Army Publishing Directorate Web site at <www.apd.army.mil>.

- DA Form 2028. *Recommended Changes to Publications and Blank Forms*.
- DA Form 2203. *Demolition Reconnaissance Record*.

WEB SITES

- Army Knowledge Online, Doctrine and Training Publications Web site, <<https://armypubs.us.army.mil/doctrine/index.html>>, accessed on 4 December 2015.
- Army Publishing Directorate, Army Publishing Updates Web site, <http://www.apd.army.mil/AdminPubs/new_subscribe.asp>, accessed on 4 December 2015.
- Reachback Engineer Data Integration Smartcard Web site. <https://redi.usace.army.mil/sites/uroc/Reference%20Documents/Manuals%20and%20Handbooks/SWEAT-IR/SWEAT_inspection_forms_all_2015_FEB.pdf>, accessed on 4 December 2015.
- Reachback Engineer Data Integration Web site. <<https://uroc.usace.army.mil/>>, accessed on 4 December 2015.
- Reachback Operations Center Web site. <<https://uroc.usace.army.mil/>>, accessed on 4 December 2015.
- Teleengineer Emergency Operations Center, Reachback Operations Center Web site. <<https://uroc-redi-sso.usace.army.mil/USACE/SelfReg.aspx?SITE=UROC>>, accessed on 4 December 2015.

RECOMMENDED READINGS

- AAP-06. *NATO Glossary of Terms and Definitions (English and French)*. 2 May 2014. Web site <http://nso.nato.int/nso/ZPUBLIC/BRANCHINFO/TERMINOLOGY_PUBLIC/NON-CLASSIFIED%20NATO%20GLOSSARIES/AAP-6.PDF>, accessed 20 January 2015.
- ADP 1. *The Army*. 17 September 2012.
- ADP 2-0. *Intelligence*. 31 August 2012.
- ADP 3-07. *Stability*. 31 August 2012.
- ADP 3-28. *Defense Support of Civil Authorities*. 26 July 2012
- ADP 3-90. *Offense and Defense*. 31 August 2012.
- ADP 4-0. *Sustainment*. 31 July 2012.
- ADP 5-0. *The Operations Process*. 17 May 2012.
- ADP 6-0. *Mission Command*. 17 May 2012.

References

- ADP 7-0. *Training Units and Developing Leaders*. 23 August 2012.
- ATP 2-01. *Plan Requirements and Assess Collection*. 19 August 2014.
- ATP 3-34.22. *Engineer Operations—Brigade Combat Team and Below*. 5 December 2014.
- ATP 3-34.40/MCWP 3-17.7. *General Engineering*. 25 February 2015.
- ATP 3-34.80. *Geospatial Engineering*. 23 June 2014.
- ATP 4-32.16/MCRP 3-17.2C/NTTP 3-02.5/AFTTP 3-2.32. *EOD Multi-Service Tactics, Techniques, and Procedures for Explosive Ordnance Disposal*. 6 May 2015.
- ATTP 4-10. *Operational Contract Support Tactics, Techniques, and Procedures*. 20 June 2011.
- FM 3-20.96. *Reconnaissance and Cavalry Squadron*. 12 March 2010.
- FM 3-39. *Military Police Operations*. 26 August 2013.
- FM 3-96. *Brigade Combat Team*. 8 October 2015.
- FM 90-5. *Jungle Operations*. 16 August 1982.
- GTA 05-07-013. *Rapid Field Classification Booklet*. 1 July 2006.
- TC 3-25.26. *Map Reading and Land Navigation*. 15 November 2013.
- TM 3-34.45. *Engineer Prime Power Operations*. 13 August 2013.
- TM 3-34.85/MCRP 3-17A. *Engineer Field Data*. 17 October 2013.
- TM 5-349. *Arctic Construction*. 19 February 1962.
- UFC 3-230-01. *Water Storage, Distribution, and Transmission*. 1 November 2012.
- UFC 3-535-01. *Visual Air Navigation Facilities*. 17 November 2005

Index

Entries are by paragraph number.

A
Air Force airfields
 mission categories, 5-52
airfield assessment, 5-45
airfields
 pavement types, 5-53
area reconnaissance, 2-25
 as part of tactical capabilities,
 1-8
assessment and survey
 teams, 1-30
assessment teams, 5-34

B
breaching operation, 3-11
bridge
 condition, 5-3
 symbol, 5-4
bridge reconnaissance, 5-1

C
classification numbers, D-1
combat engineer reconnaissance
 tasks, 1-9
commander
 and reconnaissance
 operations, 1-2
 reconnaissance guidance, 2-6
complex terrain, 3-64
 arctic and cold regions, 3-94
 deserts, 3-88
 jungles and forests, 3-77
 mountains, 3-82
countermobility operations, 3-36
 obstacle placement, 3-37
curve calculations, 4-17
 tape measure method, 4-19

E
engineer
 reconnaissance, 1-4
engineer reconnaissance
 capabilities of, 1-9
 other types, 3-95
engineer reconnaissance reports
 types of, B-2

engineer reconnaissance team
 duties of, 1-17
 limitations of, 1-22
 obstacle reconnaissance, 3-4
 training, 1-16
environmental reconnaissance,
 5-44

F
ferries, 5-16
forms of reconnaissance, 2-14

G
gap-crossing sites
 ferry, 5-16
 ford, 5-9
 underwater, 5-32
general engineer
 technical capabilities, 1-10

I
infrastructure assessment, 5-46;
 C-1
infrastructure protection, 5-43
infrastructure reconnaissance, C-4
infrastructure survey, C-1
intelligence, surveillance, and
 reconnaissance
 assets, 1-36
 planning, 2-1
 staff support of, 2-3

M
maintain countermobility
 operations
 obstacle integration, 3-40
mobility operations, 3-1
 combat roads and trails, 3-23
 gap crossing, 3-16
 obstacle reconnaissance, 3-4

P
percent of slope
 angle-of-slope method, 4-32
 clinometer method, 4-28
 map method, 4-29
 pace method, 4-30

R
reconnaissance guidance
 engagement criteria, 2-11
 focus, 2-7
 tempo, 2-8
reconnaissance operations
 range of, 1-4
road reconnaissance, 4-48
 base course and subgrade,
 4-50
 road capacity computations,
 4-52
route classification, 4-2
 bypasses, 4-6
 overlay, 4-5
 symbols, B-1
route classification formula, 4-7
route reconnaissance, 2-16
 control measures, 2-19
 critical tasks, 2-20

S
search operations, 3-96
sign lighting, F-24
slope estimation, 4-26
slope symbols, 4-33
standard route signs, F-1
 guide signs, F-11
 hazard, F-2
 regulatory signs, F-3
survivability operations, 3-41

T
technical capabilities
 of general engineers, 1-10
technical reconnaissance
 capabilities, 1-10
tunnel
 detection, 3-68
 reconnaissance, 3-73
tunnels, 3-65

U
underpass, 4-38
urban operations, 3-44

V

vehicle signs, F-18

Z

zone reconnaissance tasks, 2-24

ATP 3-34.81
MCWP 3-17.4
1 March 2016

By Order of the Secretary of the Army:

MARK A. MILLEY
General, United States Army
Chief of Staff

Official:

A handwritten signature in black ink, appearing to read "Gerald B. O'Keefe". The signature is written in a cursive style with a large initial "G" and "O".

GERALD B. O'KEEFE
Administrative Assistant to the
Secretary of the Army
1602802

DISTRIBUTION:

Active Army, Army National Guard, and United States Army Reserve: Distributed in electronic media only (EMO).

